

PC-3110

Intelligent

pH/ORP

Transmitter

Operation
Manual

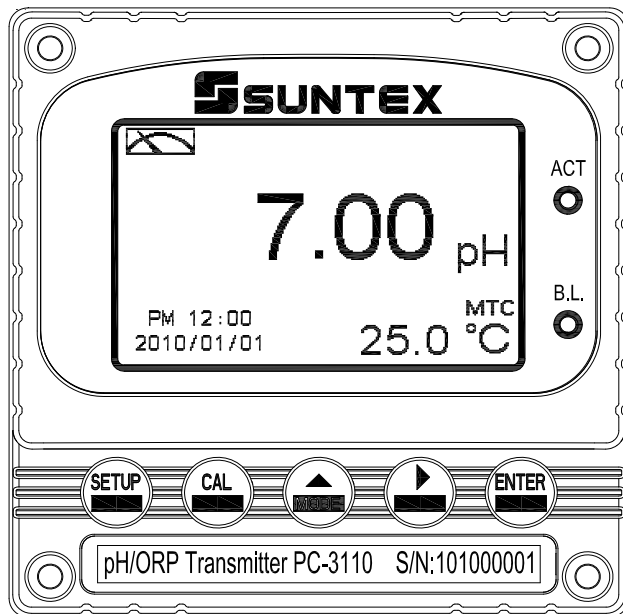

Precautions for installation

Wrong wiring will lead to breakdown or electrical shock of the instrument, please read this operation manual clearly before installation.

- Make sure to remove AC power from the controller before wiring input, output connections, and remove it before opening the controller housing.
- The installation site of the controller should be good in ventilation and avoid direct sunshine.
- The material of signal cable should be special coaxial cable. Strongly recommend using our coaxial cable. Do not use normal wires instead.
- Avoid electrical surge when using power. Especially when using three-phase power, use ground wire correctly.
- The internal relay contact of the instruments is for alarm or control function. Due to safety, please must connect to external relay which can stand enough ampere to make sure the safety operation of the instruments. (Please refer to chapter 3.7 “Illustration of electrical connection”)

CONTENTS



Precautions for installation

Brief Instruction	1
1. Specifications	4
2. Assembly and installation	
2.1 Transmitter installation.....	5
2.2 Illustration of panel mounting.....	5
2.3 Illustration of Wall mounting and pipe mounting.....	6
2.4 Assembly of electrode and housing.....	6
2.4.1 Cable set-up.....	6
2.4.2 Assembly of housing PP-100A.....	7
2.5 Illustration and description of junction box.....	8
3. Overview of Intelligent pH/ORP transmitter PC-3110	
3.1 Illustration of rear panel.....	10
3.2 Illustration of terminal function.....	10
3.3 Description of terminal function.....	11
3.4 Installation of transmitter PH-300T.....	12
3.5 Connection of transmitter and accessional transmitter PH-300T.....	12
3.6 Typical wirings.....	13
3.7 Illustration of electrical connection.....	14
4. Configuration	
4.1 Illustration of front panel.....	15
4.2 Keypad.....	15
4.3 LED indicators.....	15
4.4 Display.....	16
5. Operation	
5.1 Measurement mode.....	17
5.2 Set-up menu.....	17
5.3 Calibration menu.....	17
5.4 Reset	
5.4.1 Set-up reset.....	17
5.4.2 Calibration reset.....	17
6. Settings	
Block diagram of settings.....	18
6.1 Entry of set-up menu.....	19
6.2 Security code of settings(Code).....	20
6.3 Measurement parameters(Mode).....	21







6.4	Multi-point calibration(Multi-Cal)	22
6.5	Temperature	23
6.6	Relay 1	24
6.7	Relay 2	25
6.8	Wash time(Clean)	26
6.9	Analog output 1 (pH/ORP)	27
6.10	Analog output 2 (temperature)	28
6.11	Date/Time (Clock)	29
6.12	Sample average of measurements (Digital filter)	30
6.13	Backlight settings	31
6.14	Contrast settings	32
6.15	Automatically back to measurement mode(Return)	33
7.	Calibration	
	Block diagram of Calibration	34
7.1	Entry of calibration menu	35
7.2	Security password of calibration	36
7.3	Automatically back to measurement mode(Return)	37
7.4	pH calibration	38
	7.4.1 TECH mode (Up to 3-point calibration)	38
	7.4.2 NIST mode (Up to 3-point calibration)	38
	7.4.3 Asymmetry mode (Up to 3-point calibration)	38
	7.4.4 Definition of calibration parameter	39
	7.4.5 TECH, NIST buffer Calibration	40
	7.4.6 Any Calibration	41
7.5	ORP calibration	42
8.	Error messages (Error code)	43
9.	Maintenance	44
Appendix		45

Brief Instruction

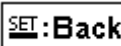

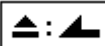
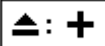

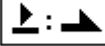
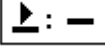

Description of set-up settings (see chapter 7 for details)







Press  and  simultaneously to see the overview of the set-up settings now. Then press  if you would like to modify set-up settings. Press keypad according to index of keypad on the screen.

Index of keypad



keypad	Accordingly item	Description
		Back to upper layer
		Choose leftward of change to left page
		Increase digit
		Choose rightward of change to right page
		Decrease digit
		Confirm settings after modifications and then go through next step

Selection of set-up items







keypad	Accordingly item	Description
Mode		Measurement mode, to choose pH or ORP measurement
Multi-Cal.		Multi-point calibration, to choose 1, 2, or 3 points calibration
Temperature		Temperature measurement and compensation, including MTC, PTC, NTC (3 types total). MTC---Manual temperature compensation, PTC/NTC--- auto temperature compensation
Relay 1		First relay setting, to choose action off or Hi/Lo alarm
Relay 2		Second relay setting, to choose action off or Hi/Lo alarm
Clean		Automatic wash time setting, to choose electrode clean equipment's ON and OFF duration
Analog 1		Current output according to pH or ORP setting range

Analog 2		Current output according to temperature setting range
Clock		Clock setting (When out of power and reboot it, the instrument's time setting will return to the factory pre-setting)
Black-light		Backlight setting, to set Auto/ON/OFF backlight, brightness, and sensitivity
Contrast		Contrast of screen setting
Digital Filter		Take every serial 1~60 measurements, average them continuously, and make it as the readings
Return		Setting of returning to the measurement mode
Code		Security code of set-up mode. The factory default is 1111, and a designated user can change the code. The set-up code is precedential to calibration code, thus it can pass a different security code of calibration.

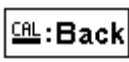

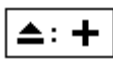
Description of calibration settings (see chapter 8 for details)

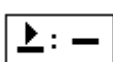
Press  and  simultaneously to see the last calibration information. Then press  if you would like to make a new calibration or modify setting of calibration. Press keypad according to index of keypad on the screen.

Index of keypad:

keypad	Accordingly item	Description
		Back to upper layer
		Choose leftward of change to left page
		Increase digit
		Choose rightward of change to right page
		Decrease digit
		Confirm settings after modifications and then go through next step

Selection of calibration items (up to three-point calibration)

keypad	Accordingly item	Description
Code		Security code of calibration mode. The factory default is 1100.
Return		Time interval setting of returning to the measurement mode
TECH	TECH	Use tech buffer as standard solution for calibration
NIST	NIST	Use NIST standard buffers(DIN 19266) as standard solution for calibration
Any	Any	Use any buffer solution by users' definition for calibration

Note

SUNTEX reserves the right to change the figure of icons and contents. The actual icons and contents please refer to the instruments.

1. Specifications

Model		PC-3110
Measuring modes		pH / ORP / Temp.
Ranges	pH	-2.00~16.00 pH
	ORP	-1999~1999 mV
	Temp.	-30.0~130.0 °C
Resolutions	pH	0.01 pH
	ORP	1 mV
	Temp.	0.1 °C
Accuracy	pH	±0.01 pH ± 1 Digit
	ORP	±0.1% ± 1 Digit
	Temp.	±0.2°C± 1 Digit
Temperature Compensation		NTC30K/ PT 1000 auto temperature compensation
		Manual adjustment temperature compensation
Calibration mode		Tech. 、 NIST. 、 Asymmetry mode, up to three point calibration
Ambient Temp.		0~50°C
Storage Temp.		-20~70°C
Input Impedance		> 10 ¹² Ω
Display		Large LCD display with environment light sensor auto/manual illumination function
Analog output 1		Isolated DC 0/4~20mA corresponding to main measurement, max. load 500Ω
Analog output 2		Isolated DC 0/4~20mA corresponding to Temp., max. load 500Ω
Settings	Contact	RELAY contact , 240VAC 0.5A Max.(recommend)
	Activate	Two sets of individual HIGH or LOW programmable control
Wash		RELAY contact: ON 0~99min. 59sec. / OFF 0~999hr 59min.
Voltage Output		DC±12V , 1W max.
Certification		IP65
Power Supply		100V~240VAC±10% , 4W max. , 50/60Hz
Installation		Wall or Pipe or Panel Mounting
Dimensions		96m × 96mm × 132mm (H×W×D)
Cut off Dimensions		93 mm × 93 mm (H×W)
Weight		0.5Kg

Note: The specifications are subject to change without notice.

2. Assembly and installation

2.1 Transmitter installation: This Transmitter can be installed through panel mounting, wall mounting and pipe mounting.

Installation of panel mounting: First, prepare a square hole of 93 x 93mm on the panel box, and then insert the controller directly into the panel box. Insert the accessorial mounting bracket from the rear, and make it be fixed in to pickup groove.

2.2 Illustration of panel mounting:

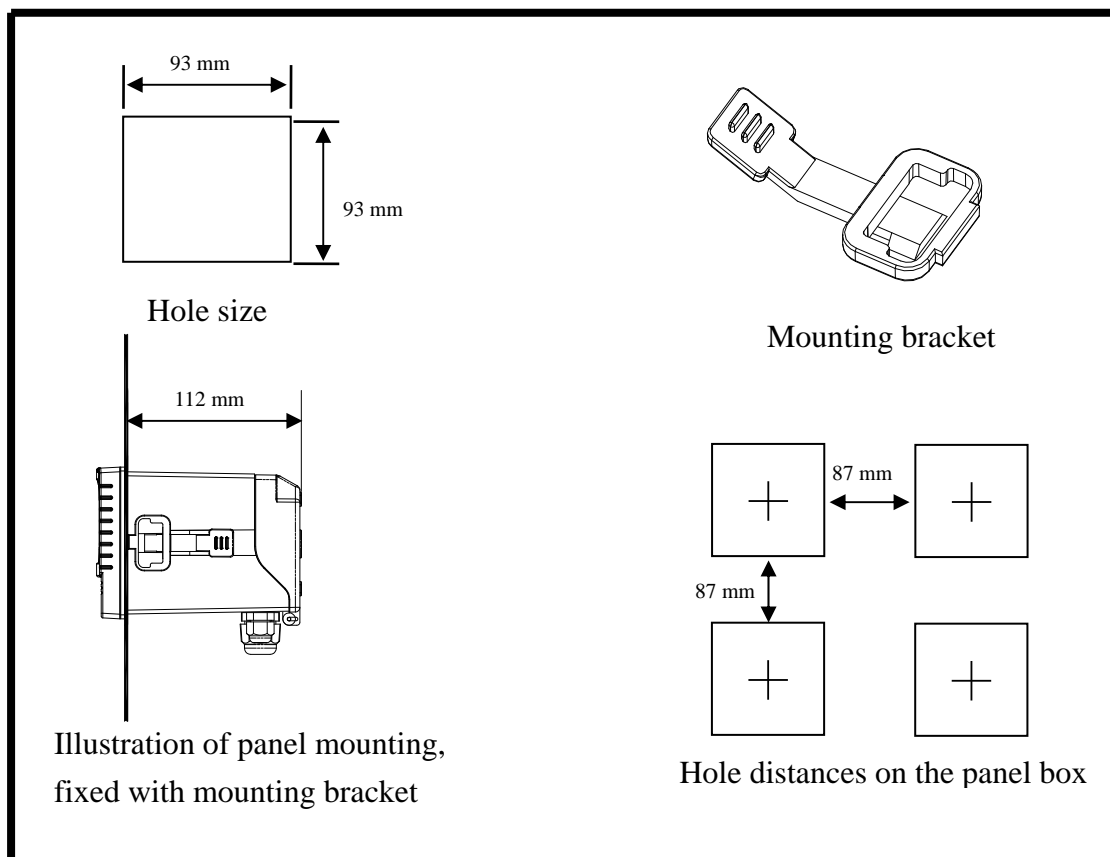

2.3 Illustration of Wall mounting and pipe mounting

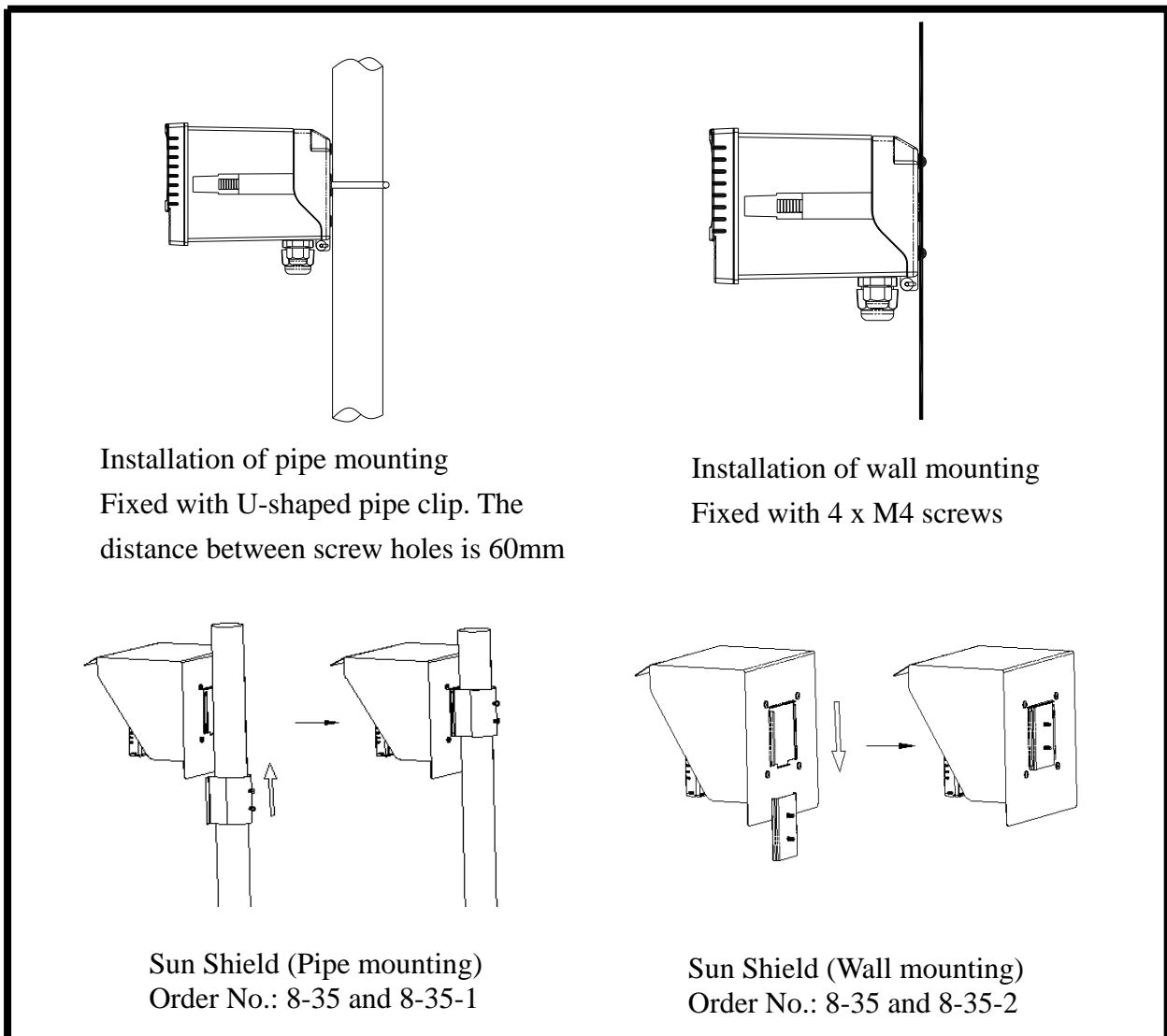

2.4 Assembly of electrode and housing

2.4.1 Cable set-up:

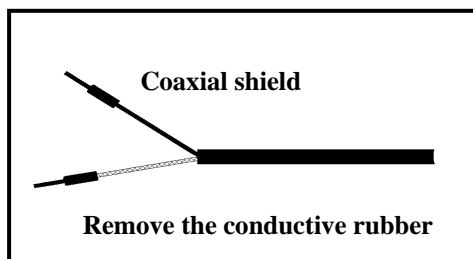

Set-up diagram of coaxial cable:

See the correct set-up method on the left:

Note: The black conductive rubber covering on the coaxial inner should be removed for use.

- a. Make sure to remove the conductive rubber or aluminum-foil paper between the electrode signal wire and the coaxial shield.
- b. Extend the cable to the controller without any joint except specific junction box. Connect the coaxial inner directly to the Glass contact on the back of controller and connect coaxial shield to Ref. contact.

2.4.2 Assembly of housing PP-100A

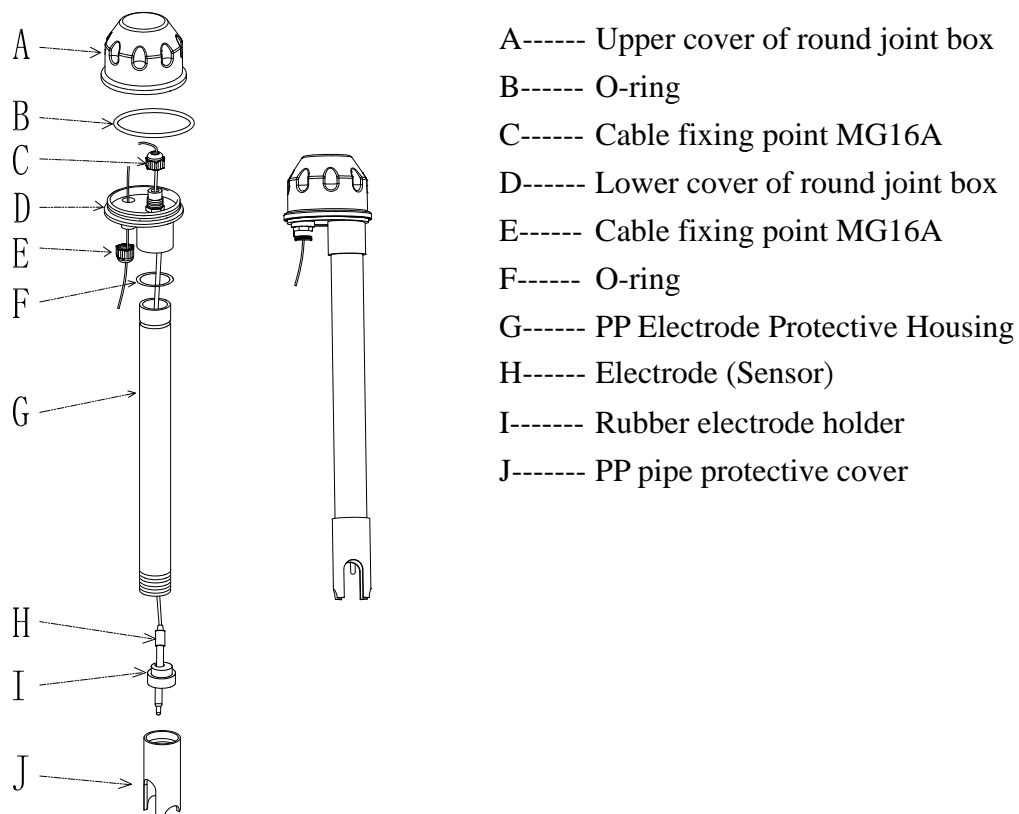

1. Insert **(H)** Electrode through **(G)** PP Electrode Protective Housing
2. Rinse **(H)** Electrode properly, so that it can be easily pass through **(I)** Rubber electrode holder, leave about 5cm bellow.
3. Install the prepared **(I)** Rubber electrode holder into **(G)** PP Electrode Protective Housing and lock **(J)** PP pipe protective cover tightly.
4. Insert **(H)** Electrode cable through **(D)** Lower cover of round junction box and **(C)** Cable fixing point, and use **(D)** Lower cover of round junction box to lock **(G)** PP Electrode Protective Housing tightly.
5. Prepare 15cm cable in the PP pipe, and then lock **(C)** Cable fixing point MG16A tightly. Leave **(H)** Sensing electrode cable for about 12-14cm, and split it carefully.
6. Fix the terminal of electrode coaxial inner on terminal block 1 of round holder; Fix the terminal of electrode coaxial shield on terminal block 3. (See the instruction of junction box)
7. Extend the cable to pass through **(E)** Cable fixing point on **(D)** Lower cover of round junction box, and lock **(E)** Cable fixing point MG16A tightly, leaving 12-14cm in the box for split.
8. Extend the lead coaxial inner and electrode coaxial inner to connect them; extend the lead coaxial shield to fix on the terminal block 3. Lock **(A)** Upper cover of round junction box to finish the installation.

Mounting bracket:

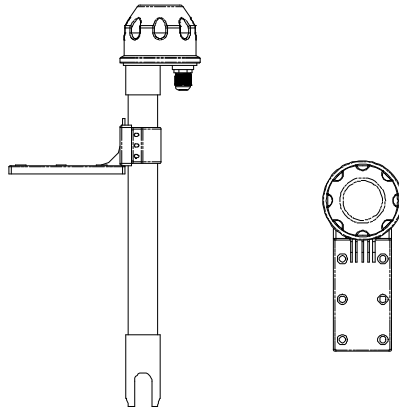

Our company use L-shaped mounting bracket as electrode mounting bracket. According to the site necessity, fix the bracket with steel nails or expansion bolts at proper locations by pool.

2.5 Illustration and description of junction box :(Two kinds of link distributing system)

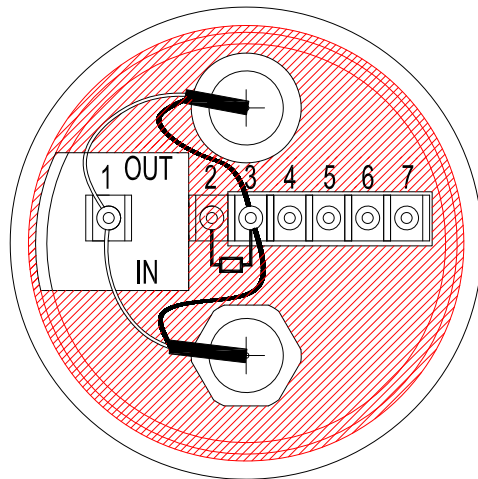

〔 1 〕 Two-wire distributing system			
INPUT terminals	Terminal No.	OUTPUT terminals	Terminals on controller
Coaxial inner	1	Coaxial inner's extending wire for electrode	GLASS
Shield (forbidden)	2	Shield (forbidden)	-----
Coaxial shield	3	Coaxial shield's extending wire for electrode	REF
Temperature probes red wire	4	Red wire's extending wire for electrode	T/P
Temperature probes green wire	5	Green wire's extending wire for electrode	GND
Alternative	6、 7	Alternative	-----

Note: 1. Our company's extending wire for electrode material No. is 7202-F94009-BK and 7202-RG-58

- 1.) If temperature probe is not used, the Order No. is 7202-RG-58.
 - 2.) If temperature probe is used, the Order No. is 7202-F94009-BK.
2. If temperatures probe 8-26-3(NTC30K) or 8-26-8(PT1000) is used for two-wire distribution, the black wire terminal should be forbidden.

(2) Three-wire distributing system			
IN terminals	Terminal No.	OUT terminals	Terminals on controller
Coaxial inner	1	Coaxial inner's extending wire for electrode	GLASS
Ground Rods	2	GND	GND
Coaxial Shield	3	Coaxial Shield's extending wire for electrode	REF
Temperature probes red wire	4	Red wire's extending wire for electrode	T/P
Temperature probes green wire	5	Green wire's extending wire for electrode	GND
Alternative	6、7	Alternative	----

- Note: 1. The black wire on the temperature probes of 8-26-3(NTC30K) or 8-26-8(PT1000) is used as special wire for Ground Rods to be connected at terminal 2.
2. The extending wire for electrode that has a temperature probe or ground rod is marked with material number 7202-F94009-BK.

3. Overview of pH transmitter PC-3110

3.1 Illustration of rear panel:

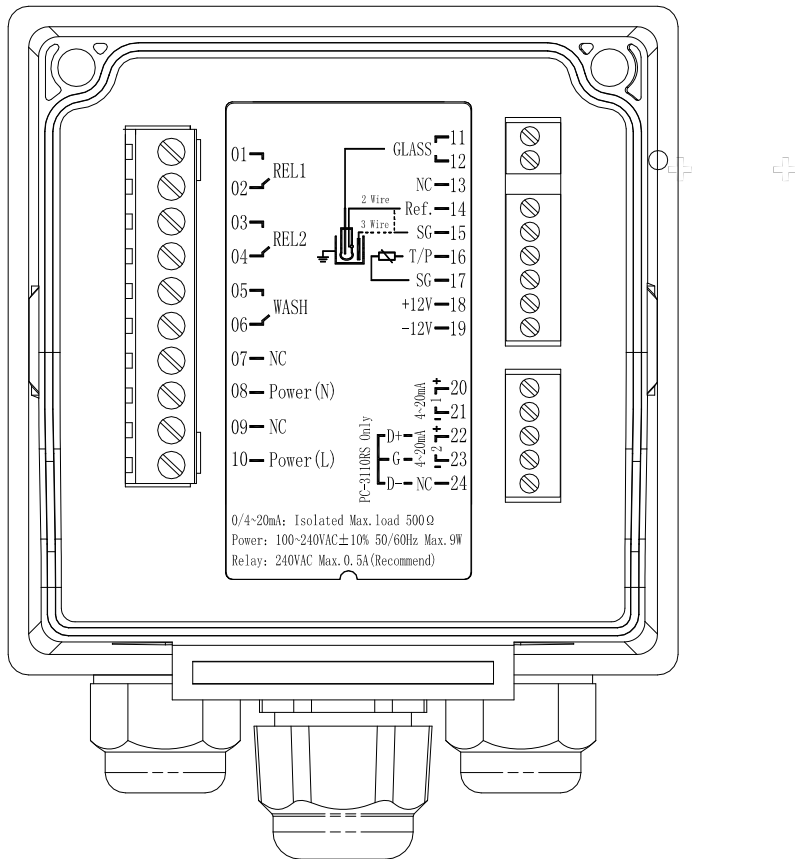

3.2 Illustration of terminal function:

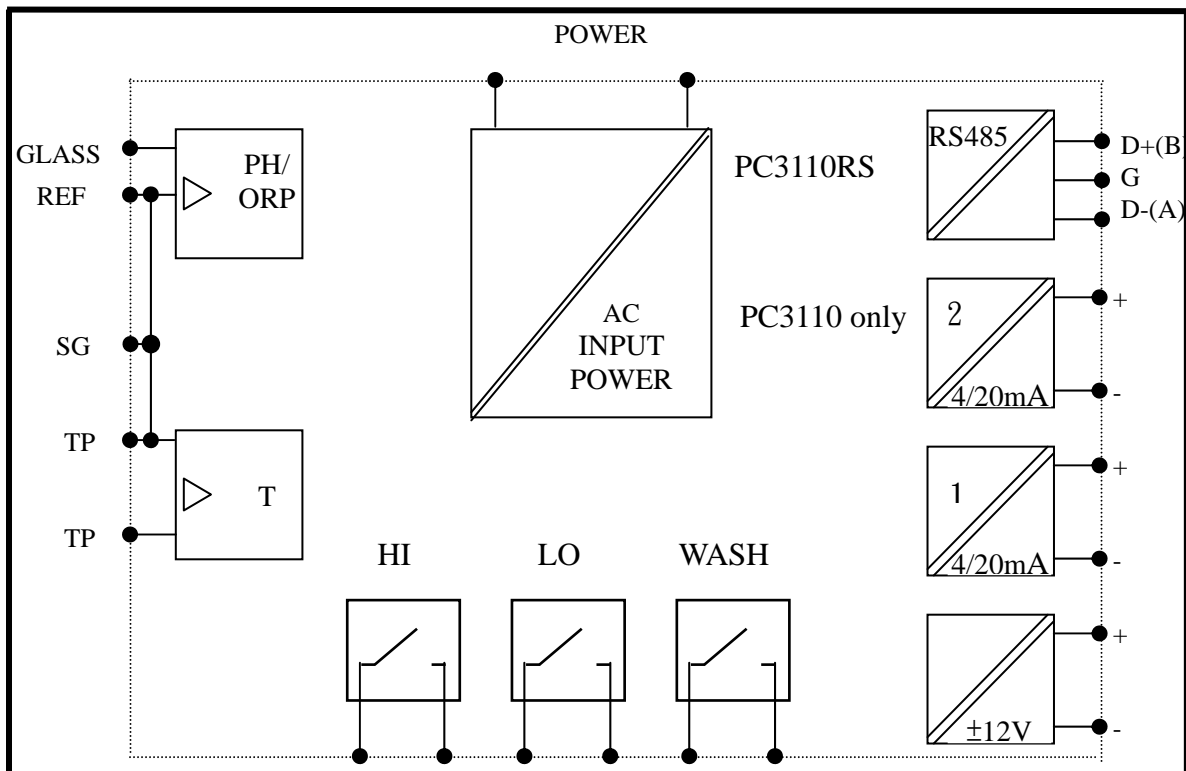

3.3 Description of terminal function:

0 1	□	REL1 : External relay terminal high control
0 2	□	
0 3	□	REL2 : External relay terminal low control
0 4	□	
0 5	□	WASH : External wash relay terminal
0 6	□	
0 7	—	NC : None contact
0 8	—	100~240AC : Power supply terminal
0 9	—	NC : None contact
1 0	—	100~240AC : Power supply terminal
1 1	□	GLASS : Coaxial inner connecting pH/ORP electrode signal wire
1 2	□	
1 3	—	NC : None contact
1 4	—	REF : Coaxial shield connecting pH/ORP electrode signal wire
1 5	—	SG : The terminal connecting temperature probe, or used as $\pm 12V$ ground potential. In two-wire distributing system, there should be a short circuit between this terminal and REF (a short circuit slice is attached when going out the factory)
1 6	—	T/P : Connect the other end of temperature probe
1 7	—	SG : The other terminal connecting temperature probe, or used as $\pm 12V$ ground potential.
1 8	□	DC$\pm 12V$: Output terminal of direct current voltage $\pm 12V$ (PH-300T only)
1 9	□	
2 0	—	4~20mA +terminal : Master measure current output terminal +, for external recorder or PLC control
2 1	—	4~20mA - terminal : Master measure current output terminal -, for external recorder or PLC control
2 2	—	4~20mA + terminal/ D+(B) : Temperature current output terminal +, for external recorder or PLC control (only applicable for PC-3110); or RS-485 output D+(B) (only applicable for PC-3110RS)
2 3	—	4~20mA - terminal G : Temperature current output terminal -, for external recorder or PLC control (only applicable for PC-3110); or RS-485 output GND (only applicable for PC-3110RS)
2 4	—	NC / D- (A) : NC or RS-485 output D-(A) (only applicable for PC-3110RS) or RS-485 output D-(A) (only applicable for PC-3110RS)

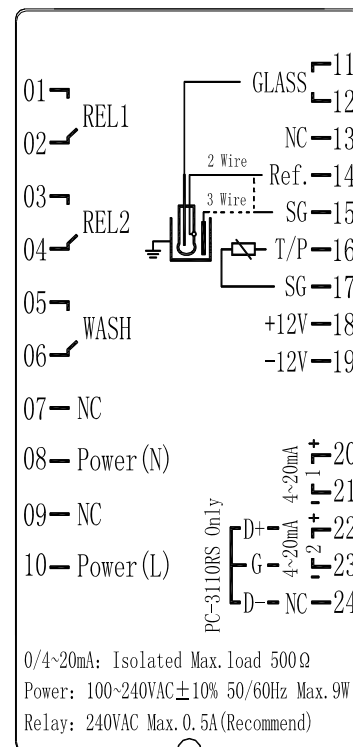

3.4 Installation of transmitter PH-300T: (alternative equipment)

PH-300T transmitter is mainly installed on the electrode protective pipe, but also can apply wall mounting and pipe mounting. For long distance transmission (100m), if PC-3110 is more than 30m far away from the electrode, PH-300T transmitter is recommended to avoid the attenuation of electrode signal, and for the convenience of onsite observation, measurement, and calibration.



3.5 Connection of transmitter PC-3110 and transmitter PH-300T:

- A. Connect the GLASS point of transmitter PH-300T's terminal to the electrode coaxial inner. (Note: Remove the black conductive rubber); connect the REF point of transmitter PH-300T's terminal to the electrode coaxial shield.
- B. See the two-wire distributing system and three-wire distributing system in the following page.
- C. Sign "PT-1000" on transmitter PH-300T's terminal is the connector for automatic temperature compensation probe, PT-1000, or applies a fixed temperature compensation resistance.
- D. The V+ and V- of transmitter PH-300T's terminal respectively connect to DC12V+ and – of the controller.
- E. The S+ and S- on transmitter PH-300T's terminal respectively connect to GLASS and REF of the controller.
- F. The I+ and I- on transmitter PH-300T's terminal are output (4-20mA), which can connect to devices that receive current signals. **(Note: The current output signal of this transmitter is not insulating, so use it with much care!)**

Note: Refer to the following table for proper fixed temperature compensation resistance

Temperature	0°C	5°C	10°C	15°C	20°C
R value	1000Ω	1019.25Ω	1038.5Ω	1057.75Ω	1077Ω
Temperature	25°C	30°C	35°C	40°C	45°C
R value	1096.25Ω	1115.5Ω	1134.75Ω	1154Ω	1173.25Ω
Temperature	50°C	55°C	60°C	65°C	70°C
R value	1192.5Ω	1211.75Ω	1231Ω	1250.25Ω	1269.5Ω
Temperature	75°C	80°C	85°C	90°C	100°C
R value	1288.75Ω	1308Ω	1327.25Ω	1346.5Ω	1385Ω

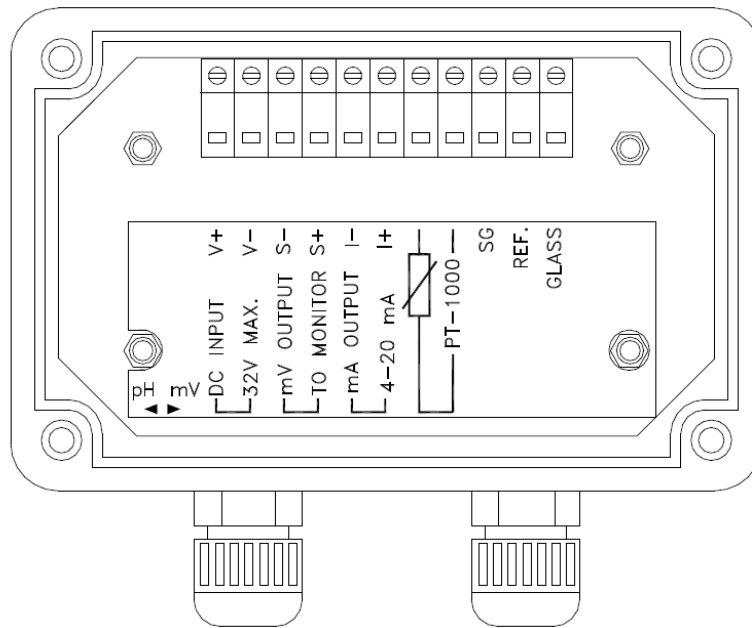

3.6 Typical wirings:

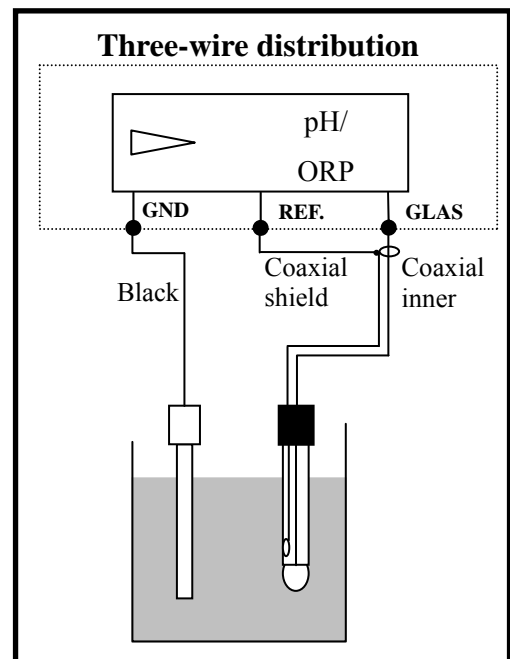
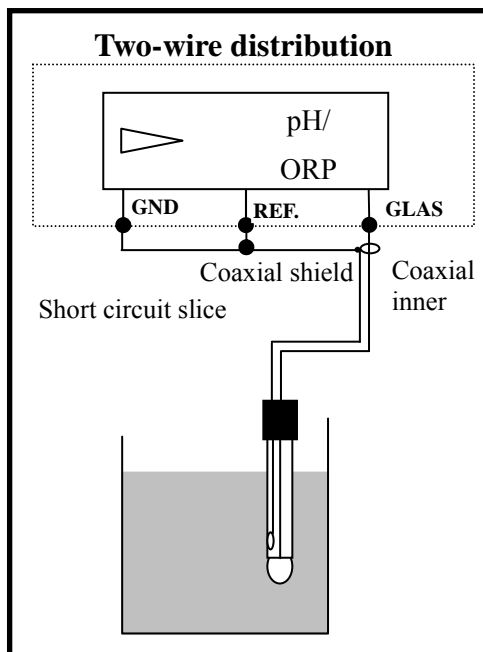

3.7 Illustration of electrical connection:

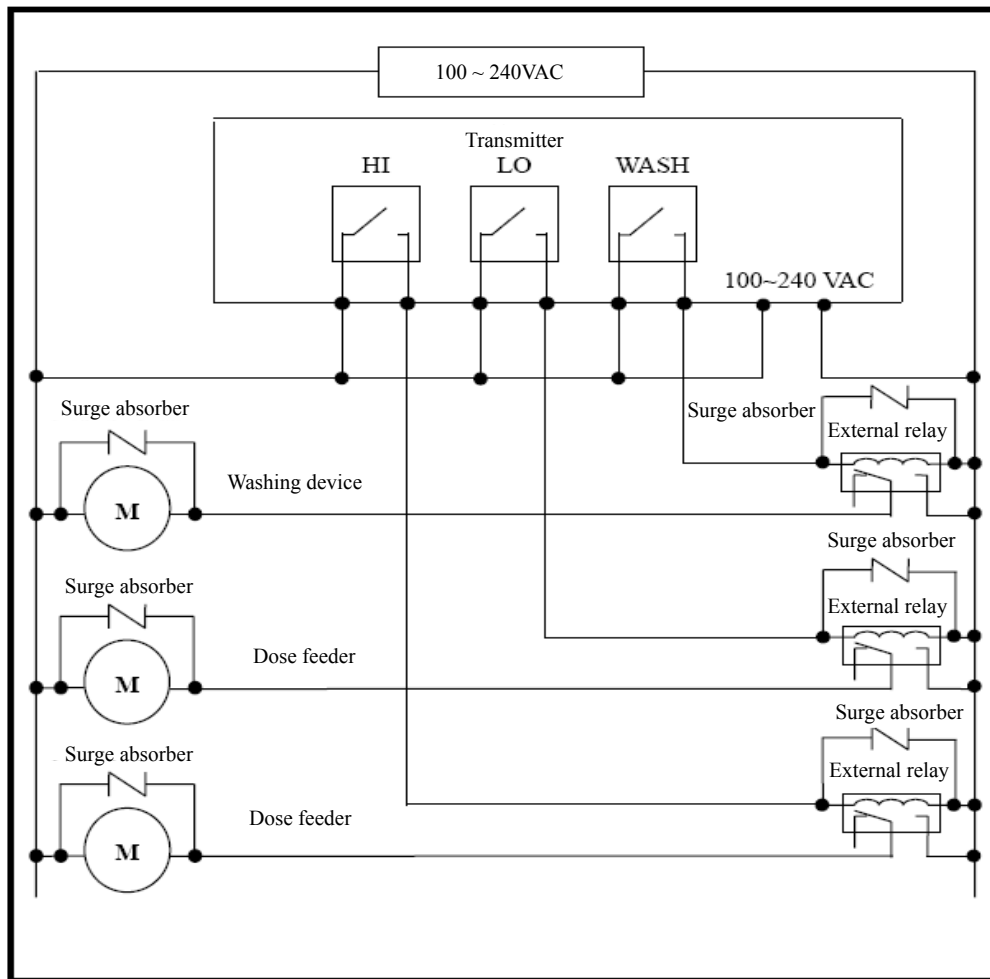

4. Configuration:

4.1 Illustration of front panel:

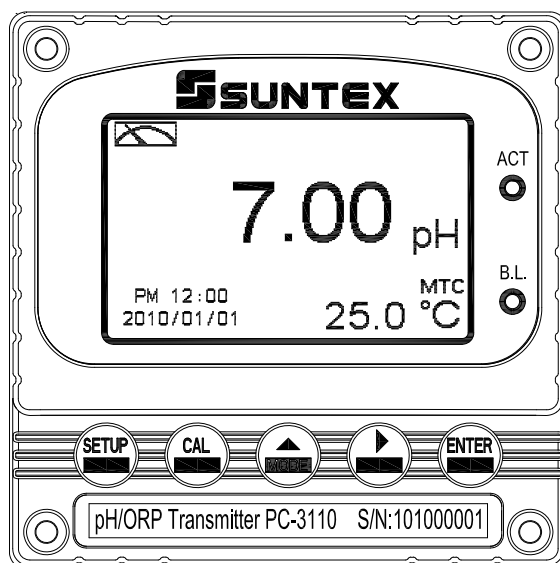

4.2 Keypad:

In order to prevent inappropriate operation by others, before the parameter setting and calibration, the operation applies multi-keys, and coding protection if necessary. Description of the key functions is in the following:



: In the parameter set-up mode, pressing this key allows you exit parameter set-up mode and back to Measurement mode.



: In the Calibration mode, pressing this key allows you exit Calibration mode and back to Measurement mode.



: 1. In the parameter set-up mode and Calibration mode, pressing this key to select leftward or change to another page.

2. When adjusting value, press this key to increase the value.



: 1. In the parameter set-up mode and Calibration mode, pressing this key to select rightward or change to another page.

2. When adjusting value, press this key to decrease the value.



: Key for confirmation; pressing this key is essential when modifying data value or selecting the parameter setting items in the window.



4.3 LED indicators:

ACT : Washing device operation indicator and controlling operation indicator (Relay 1 · Relay 2)

B.L. : Light sensor; in the automatic display backlit mode, the lamp will light or go out as the change of environmental brightness.

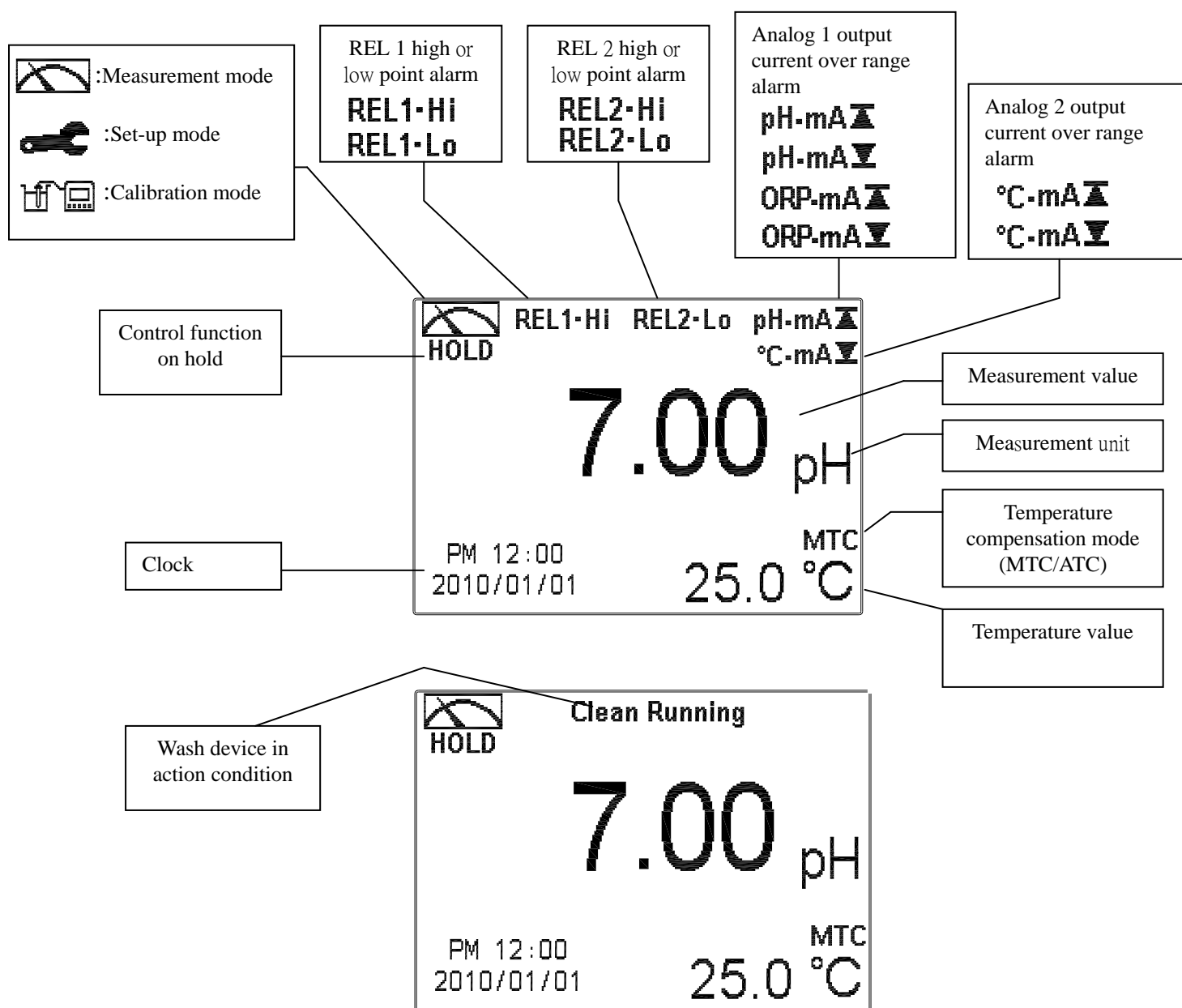
4.4 Display:





- Note: 1. When the wash device is turned on, the display shows and twinkles the description, “Clean Running”. At the same time, the ACT indicator LED lights up, and the transmitter automatically turns off Relay 1 and Relay 2 function. After finishing cleaning, the Relay 1 and Relay 2 will automatically back to normal status.
2. When Relay 1 which is set in high setting point is in action, the display shows and twinkles the description, “REL 1_Hi”, and ACT indicator LED lights up. When Relay 1 which is set in low setting point is in action, the display shows and twinkles the description, “REL 1_Lo”, and ACT indicator LED lights up.
3. When Relay 2 which is set in high setting point is in action, the display shows and twinkles the description, “REL 2_Hi”, and ACT indicator LED lights up. When Relay 2 which is set in low setting point is in action, the display shows and twinkles the description, “REL 2_Lo”, and ACT indicator LED lights up.
4. When under measurement mode, if the temperature compensation mode is set in MTC (Manual adjustment), press  or  to adjust the MTC temperature manual.

5. Operation



5.1 Measurement mode:

After all electrical connections are finished and tested, connect the instrument to the power supply and turn it on. The transmitter will automatically enter measurement mode with the factory default settings or the last settings from user.

5.2 Set-up menu:

Please refer to the set-up instructions in Chapter 6. Press  and  simultaneously to enter into set-up menu, and press  to go back to measurement mode.

5.3 Calibration menu:

Please refer to the calibration instructions in Chapter 7. Press  and  simultaneously to enter into calibration menu, and press  to go back to measurement mode.

5.4 Reset:

5.4.1 Master reset:

Measurement mode: pH
Multi-Cal : 2 points pre-setting
Temperature compensation: MTC 25°C
Relay 1 : High point alarm: AUTO, SP1= 10.00 pH, db1= 0.10 pH
Relay 2 : Low point alarm: AUTO, SP2 =04.00 pH, db2= 0.10 pH
Wash time: OFF
Analog 1 current output (pH/ORP) : 4~20 mA , 2.00~12.00pH
Analog 2 current output (Temp) : 4~20 mA , 0~100.0°C (PC3110 only)
Display backlit: Auto , Brightness= 0 , Sensitivity =0
Code set-up: OFF
Date & Time : 2010/1/1 00:00:00
Contrast: 0
Auto back: Auto, 3 minutes

5.4.2 Calibration reset:

Asy : 0 mV
Slope : -59.15 mV/pH @ 25.0°C
Calibration type : TECH-No Cal
Calibration value: None data
Auto back: Auto, 3 minutes



Note: The factory default of calibration presetting is “No Cal”, and the calibration value is “None”. It means that the user has not calibrated the sensor with the transmitter yet. After finishing every calibration, the display shows the calibration mode and the calibration value. If the equipments have not been calibrated yet, the measurement takes pre-set Asy and Slope into calculation.

6. Settings

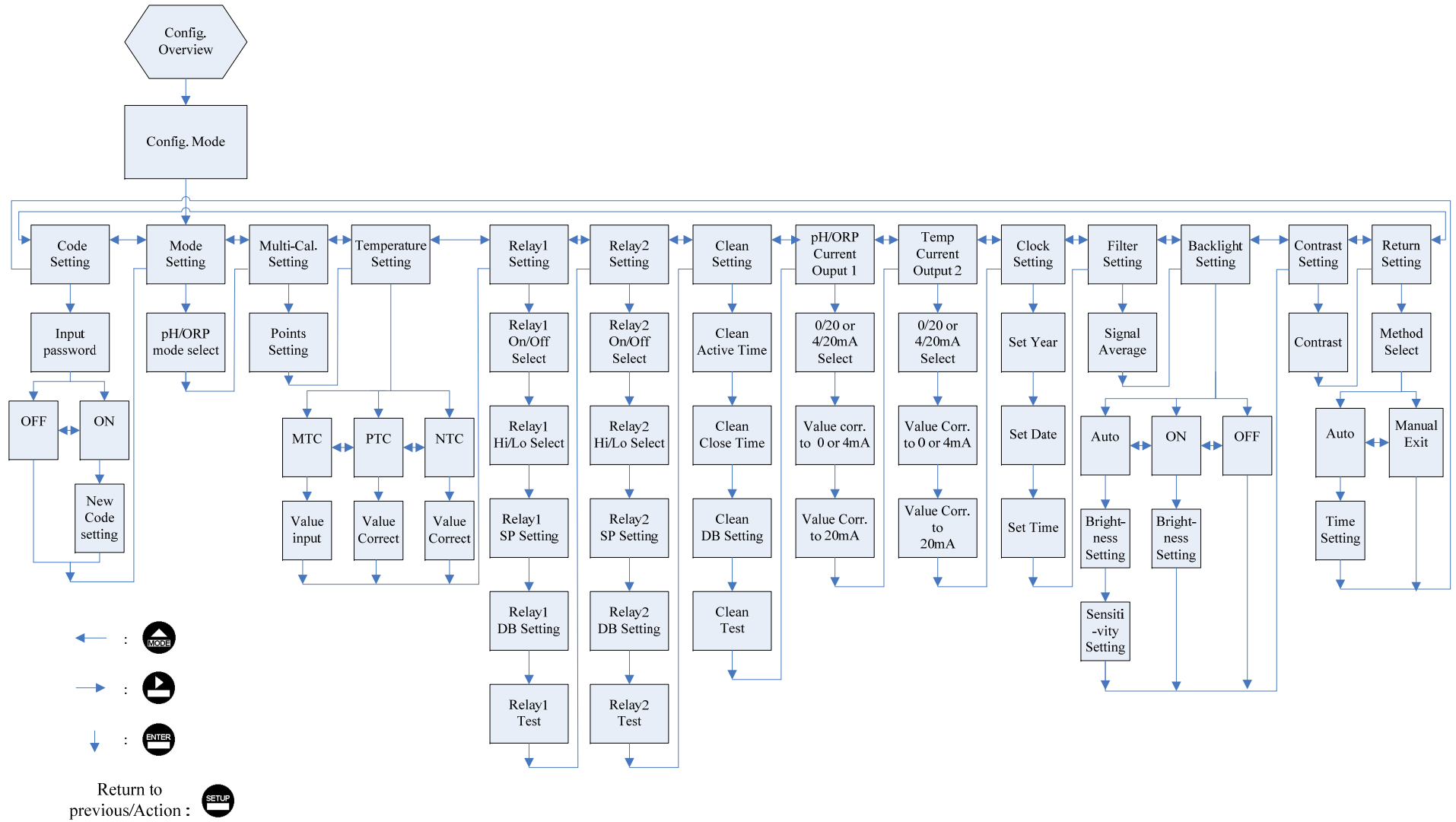
Block diagram of settings



6.1 Entry of set-up menu

In the measurement mode, pressing the two keys  and  simultaneously allows you enter the overview of current setting, and press  to enter the set-up mode to modify the setting if necessary.

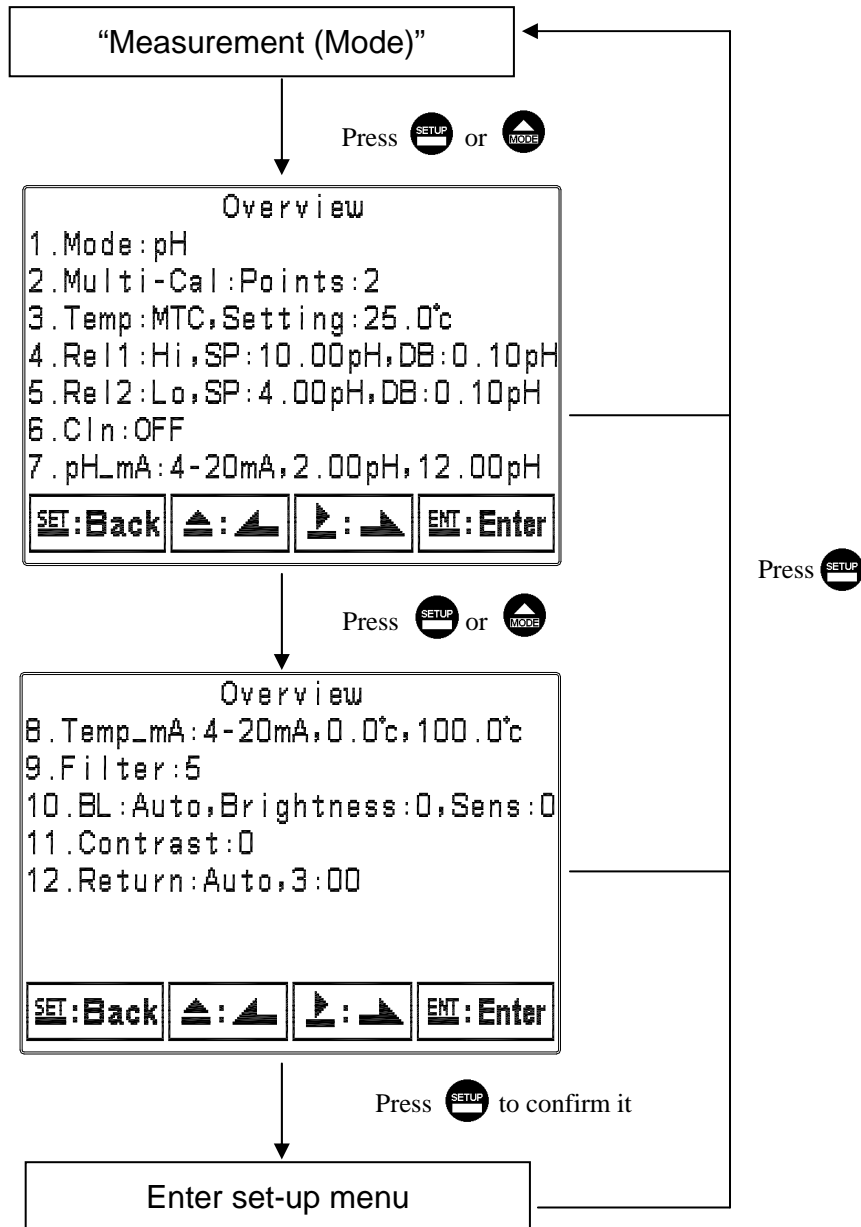

6.2 Security code of settings:

After entering set-up mode, select “code” item, press  to enter into code procedure. The code pre-setting is 1111.

Note: The code of setting mode is prior to the code for calibration. That means that the code of setting mode can be used for the code of calibration mode.

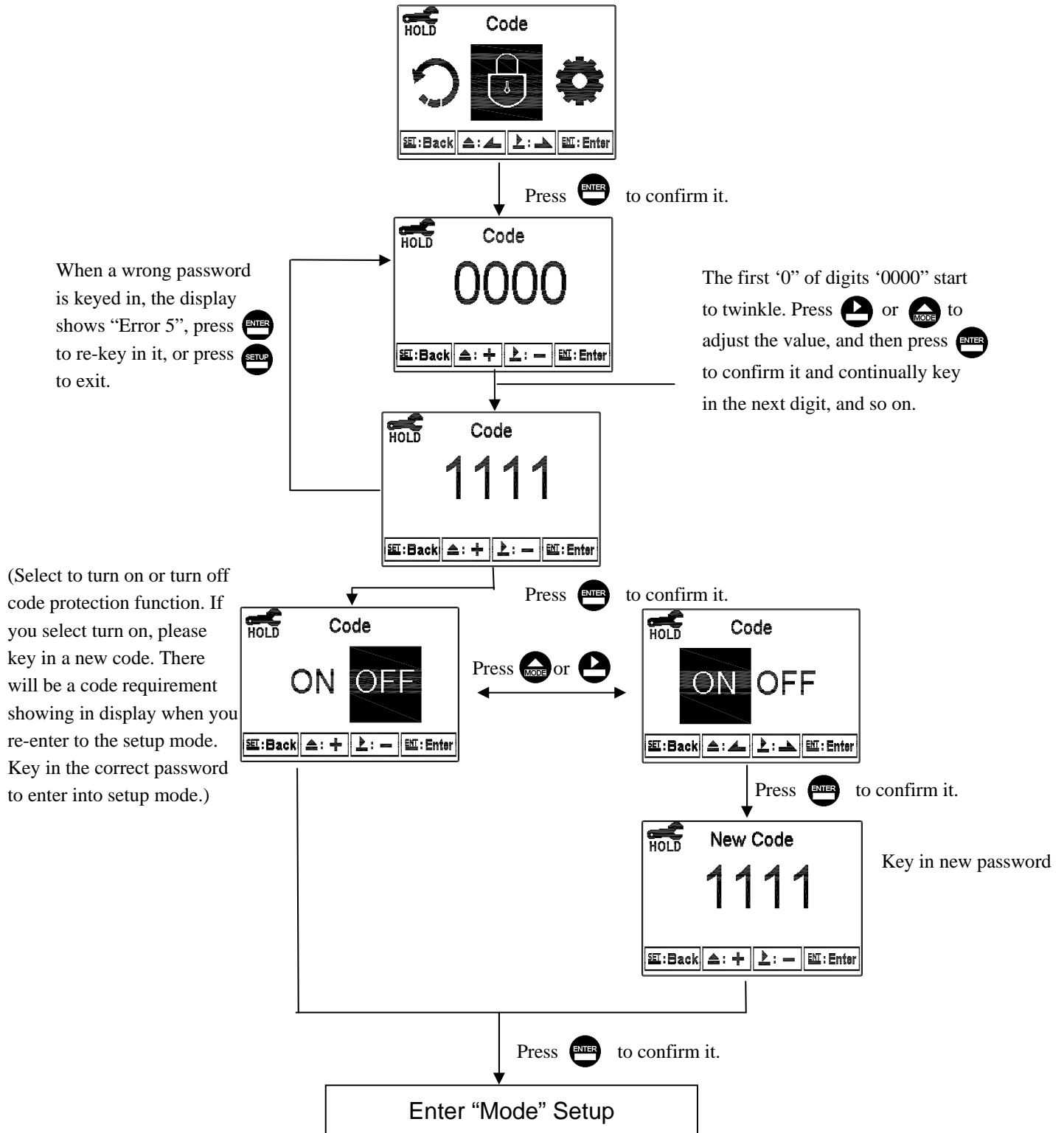

6.3 Mode

Enter setup of “Mode”. Select between “pH” or “ORP” measurement.

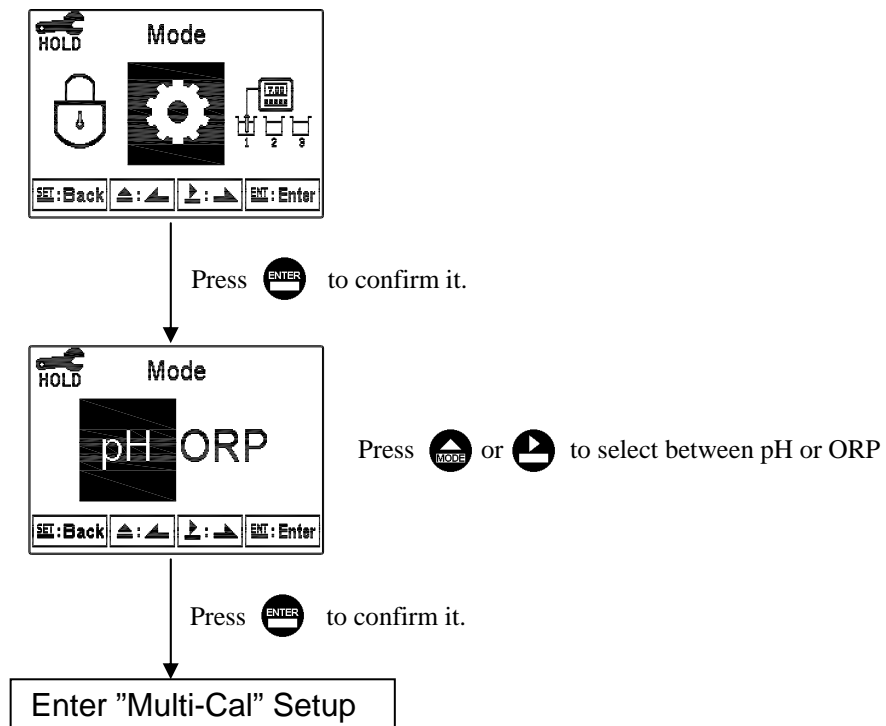

6.4 Multi-Cal

Enter setup of multi-points calibration to set the number of calibration points.

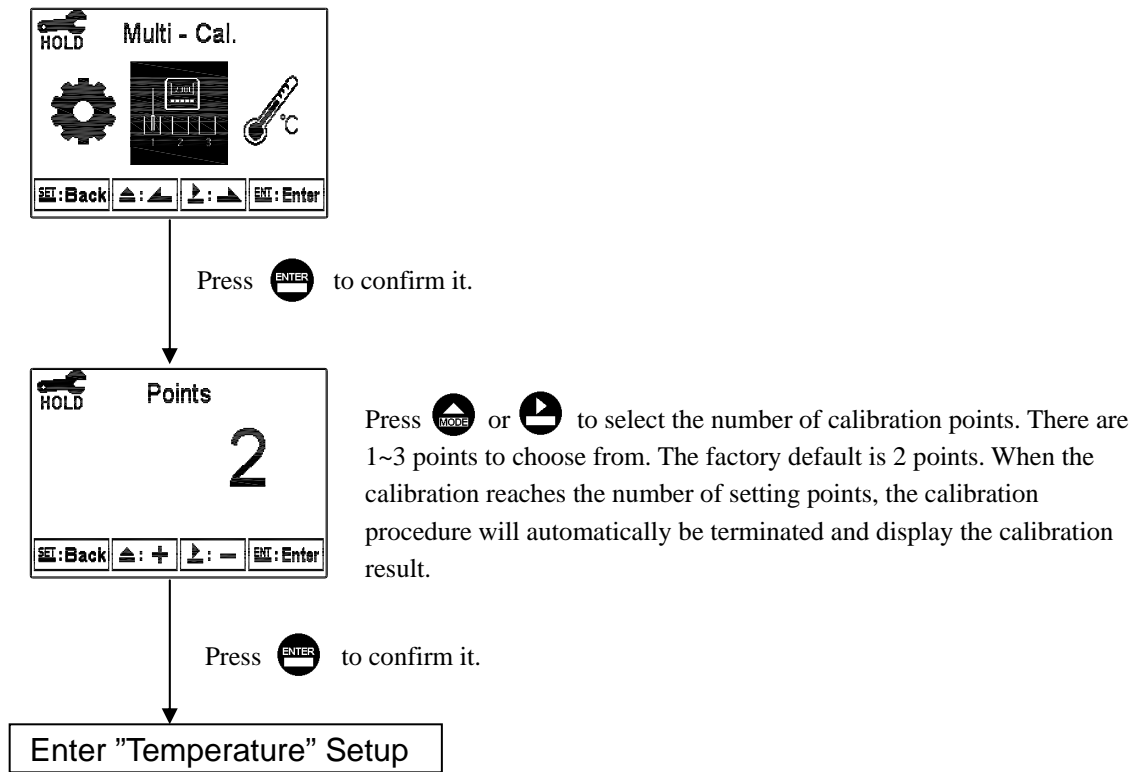

6.5 Temperature

Enter setup of “Temperature” to select temperature compensation mode. Select from NTC(NTC 30K), PTC(PT 1K) or MTC(Manual adjustment).

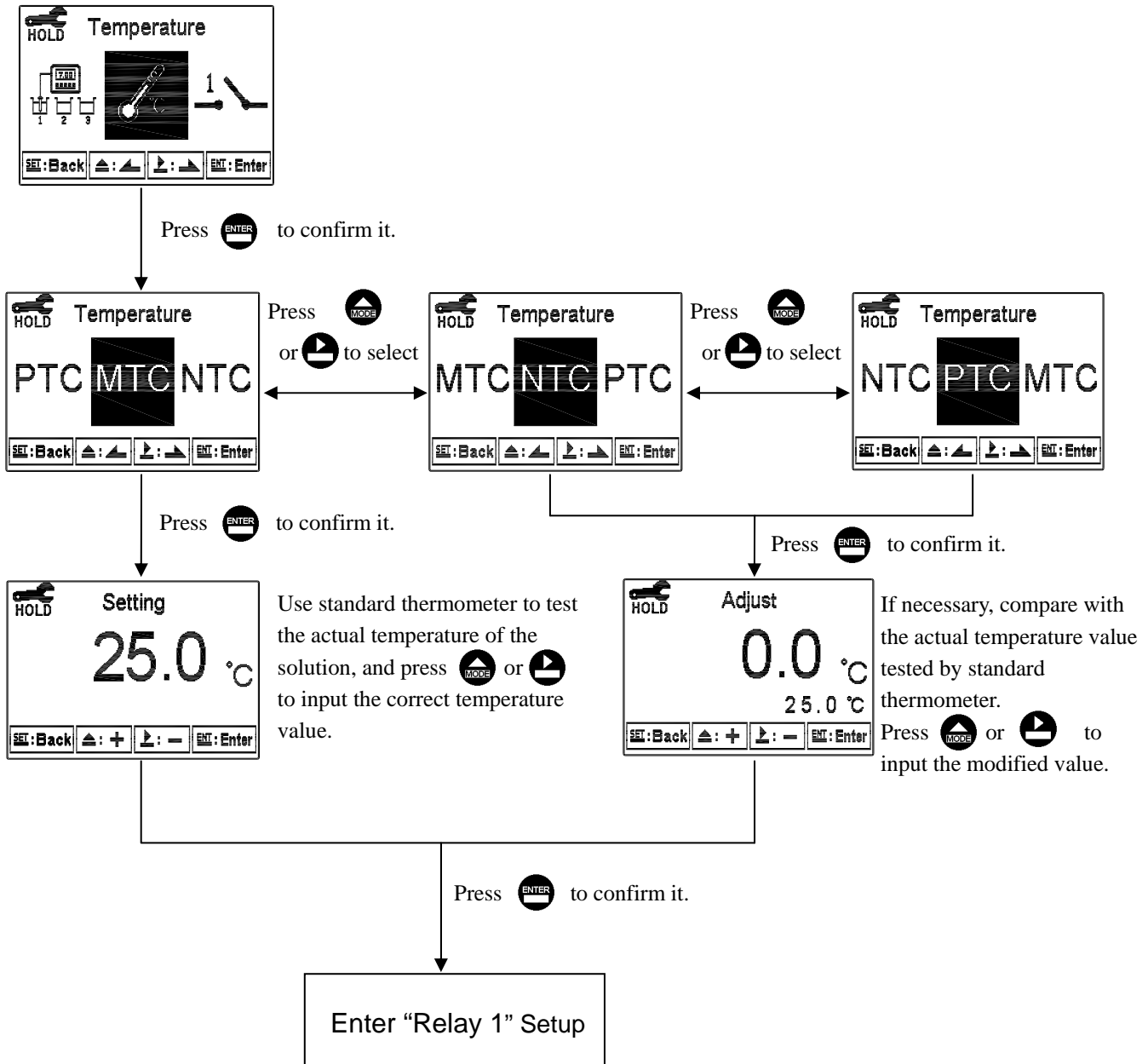

6.6 Relay 1

Enter setup of Relay 1. Select the item to turn on or turn of the relay 1 function. If you select to turn on the relay 1, then select for using relay 1 as “Hi set-point” alarm or “Low set-point” alarm. Set the value of set-point (SP) and dead-band (DB). The range for set-point is -2.00~16.00pH/-1999~1999mv; while the range for DB is 0.00~2.00pH /0~200mv.

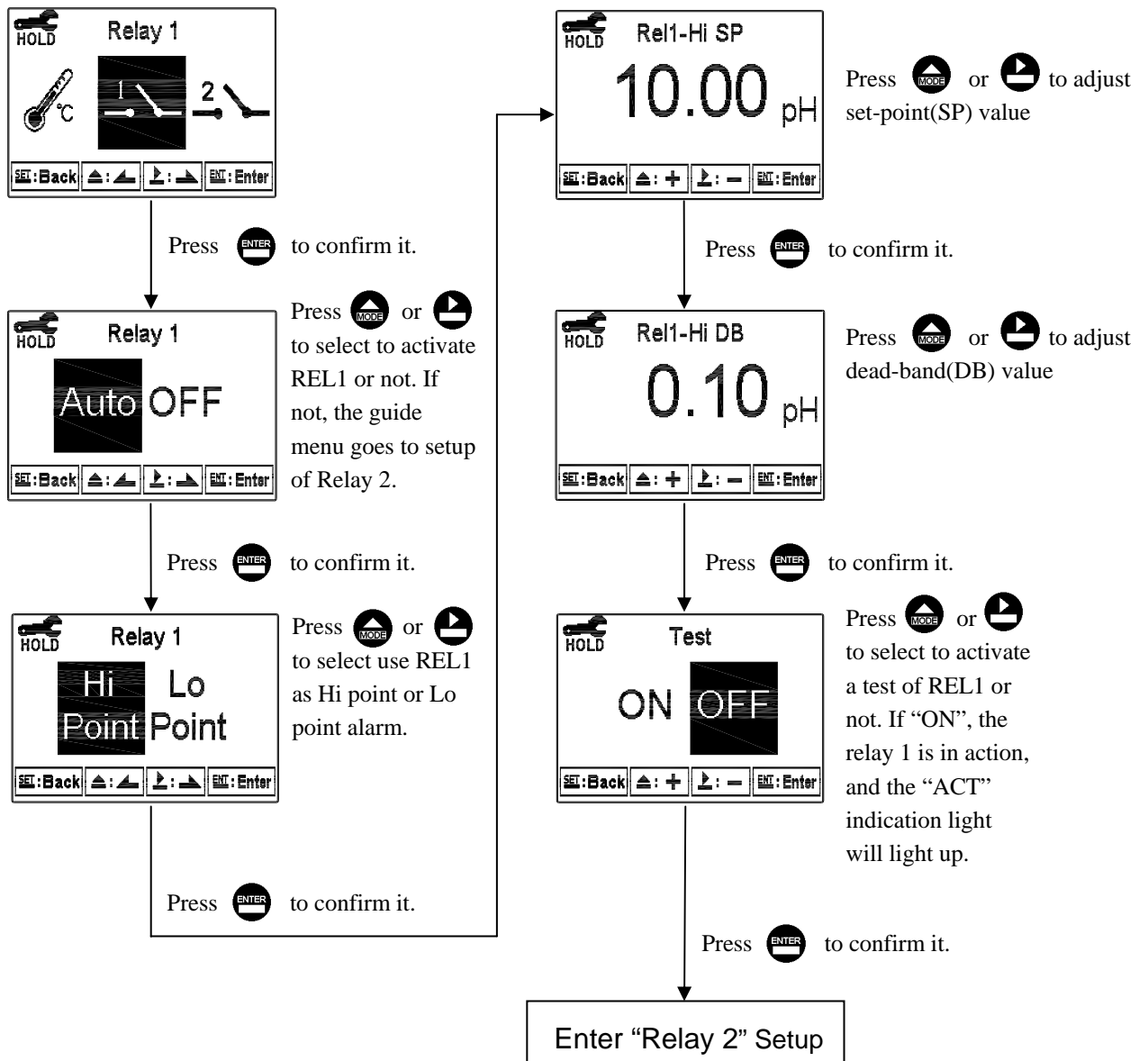

6.7 Relay 2

Enter setup of Relay 2. Select the item to turn on or turn of the relay 2 function. If you select to turn on the relay 2, then select for using relay 2 as “Hi set-point” alarm or “Low set-point” alarm. Set the value of set-point (SP) and dead-band (DB). The range for set-point is -2.00~16.00pH/-1999~1999mv; while the range for DB is 0.00~2.00pH /0~200mv.

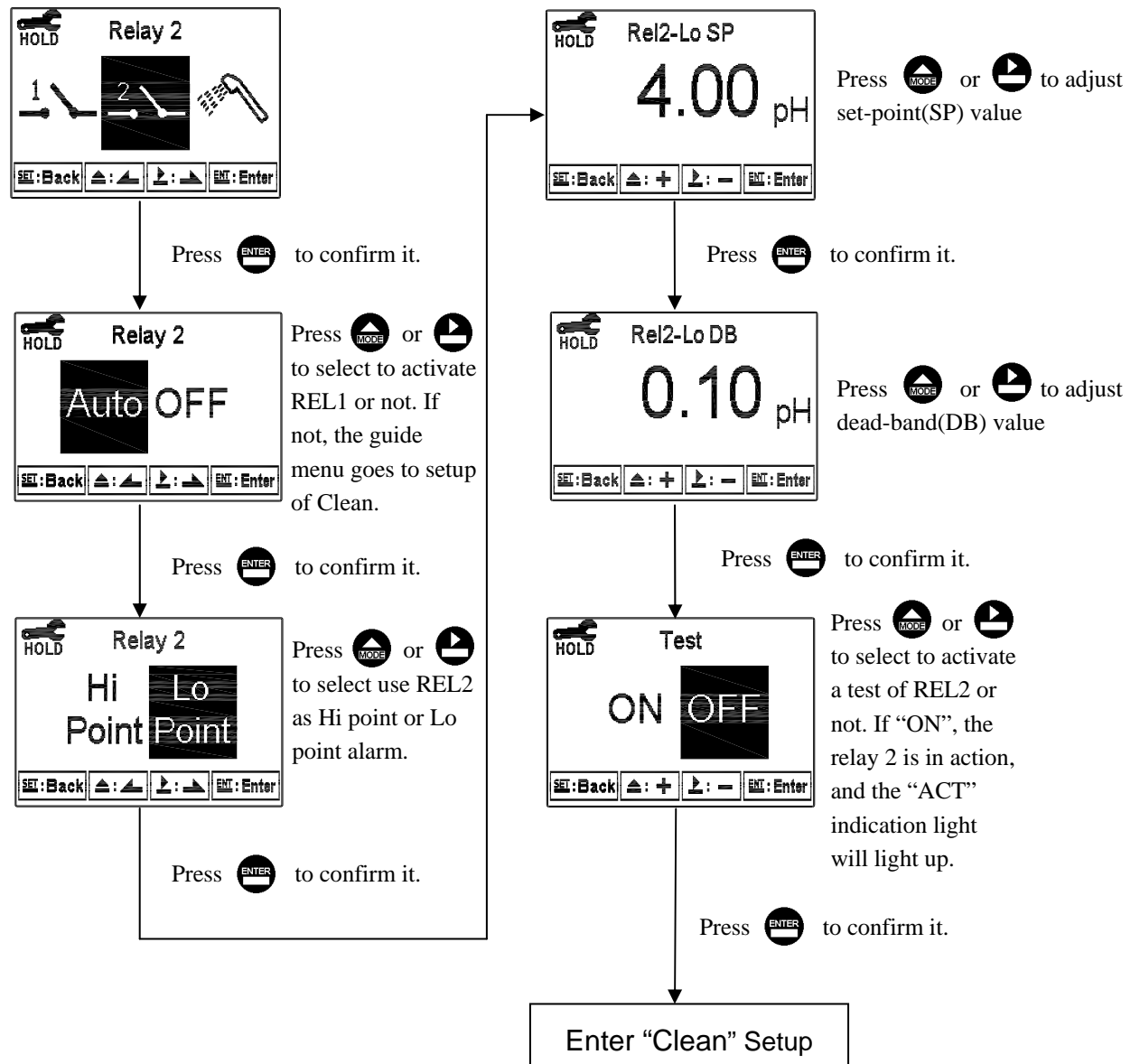

6.8 Clean

Enter setup of “Clean” function. Select the icon to turn on or turn off the clean function.

If you select “Auto” turning on, and set the timer of the clean function including automatically turning on time and turning off time, and set the bead-band value(DB).

Note: When the clean function is turned on, if any value is set to be 0, the instrument will automatically turn off this function.

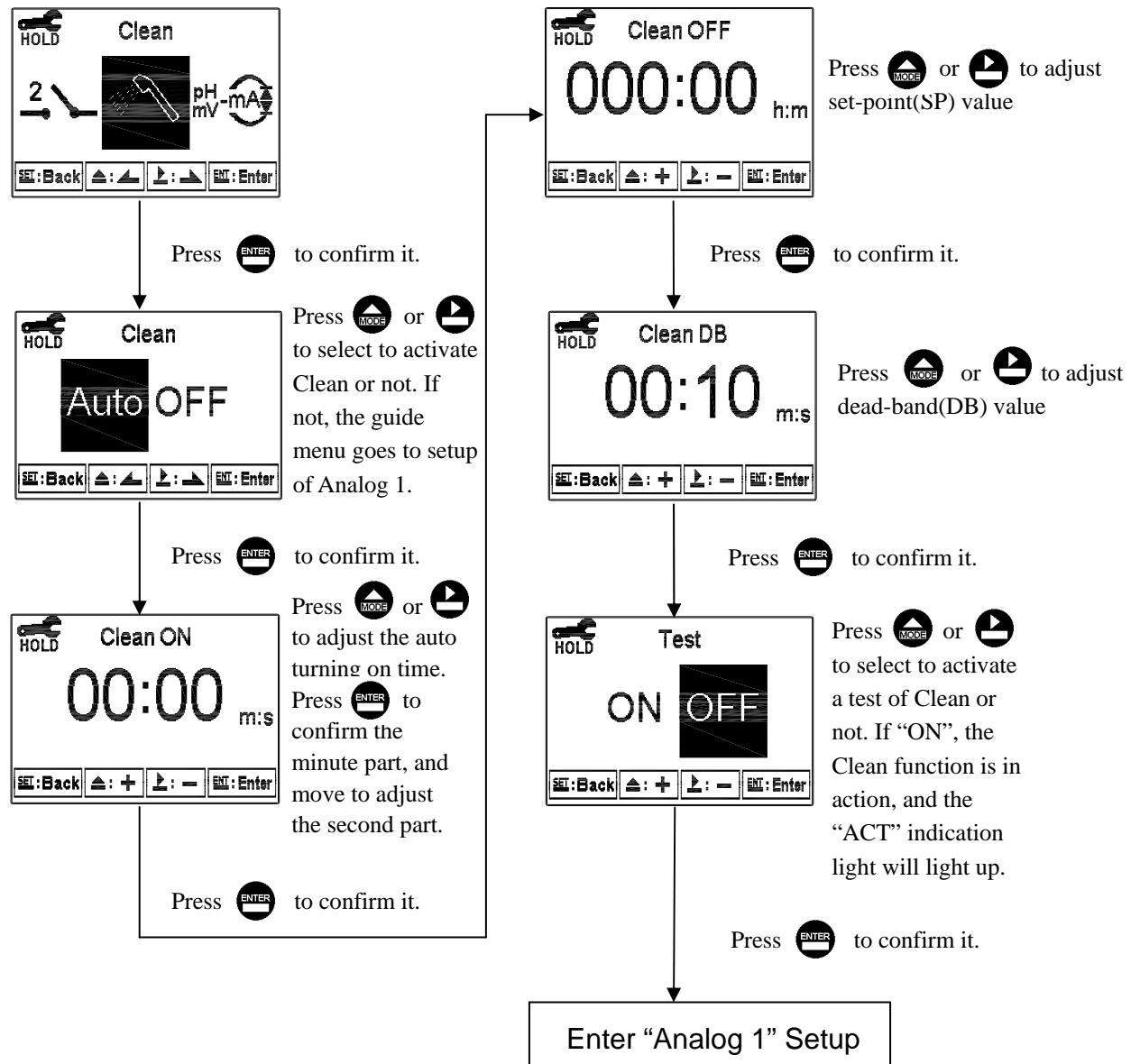

6.9 Analog output 1 (pH/ORP):

Enter setup of Analog 1. Select 0~20mA or 4~20mA current output. Set the related value to the range of pH/ORP measurement. If the range or the pH/ORP measurement is smaller, the resolution of current output is higher.

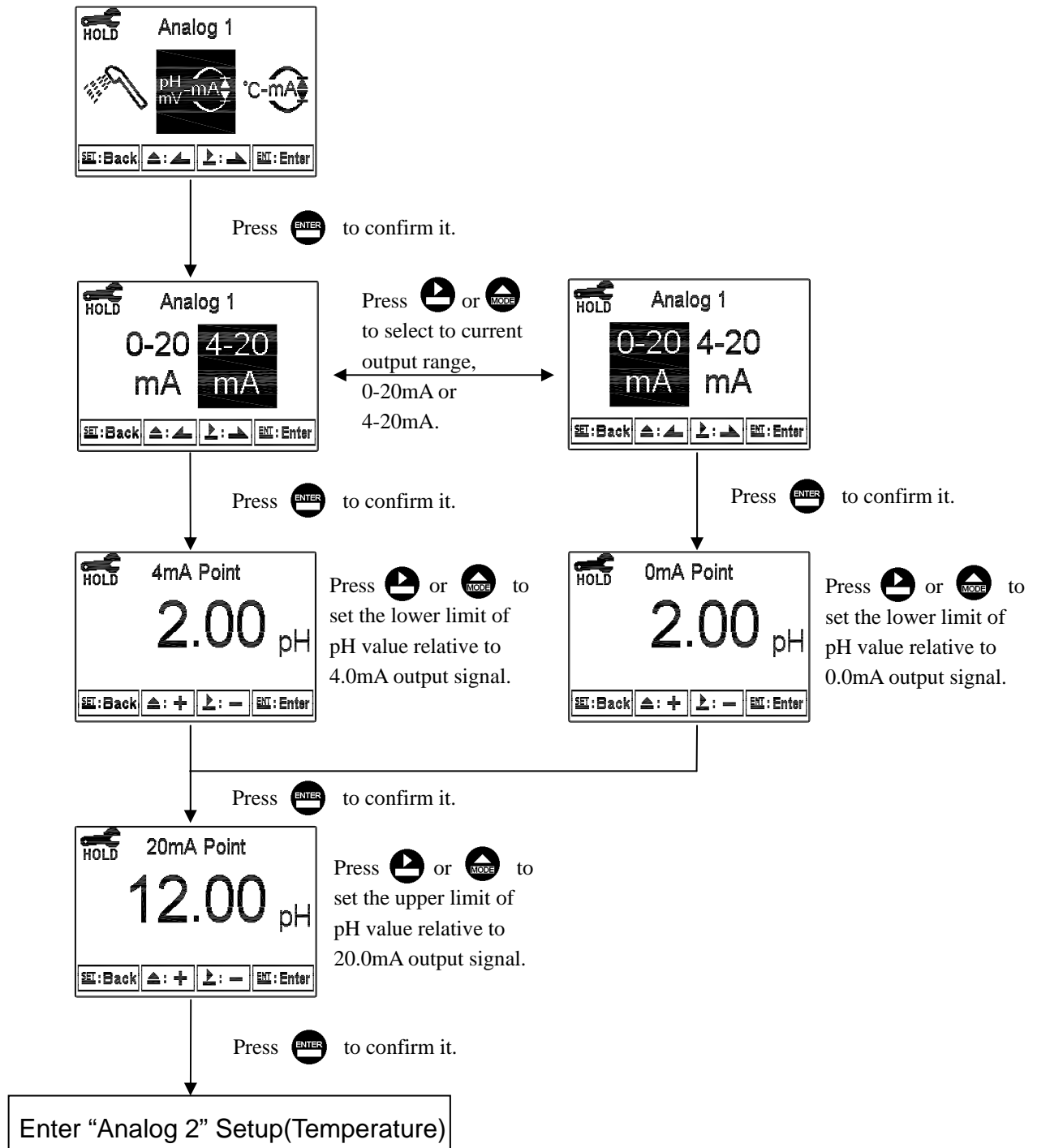

6.10 Analog output 2 (Temperature):

Enter setup of Analog 2. Select 0~20mA or 4~20mA current output. Set the related value to the range of temperature measurement. If the range or the temperature measurement is smaller, the resolution of current output is higher.

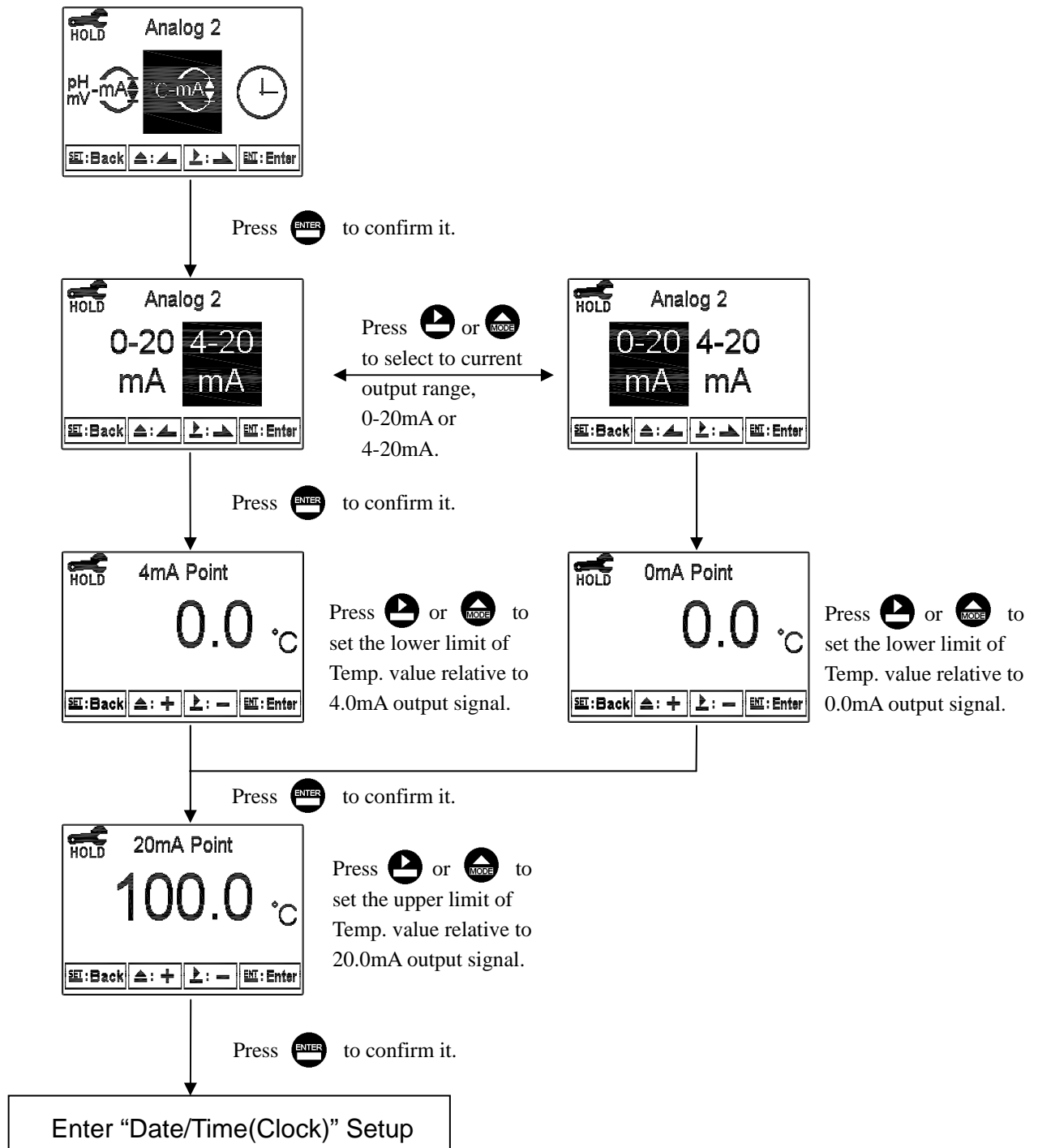

6.11 Date/Time(Clock)

Enter setup of Date/Time(Clock). Set the “Year”, “Month”, “Date”, “Hour”, and “Minute” time. Note: The clock needs to be reset once encounters power failure.

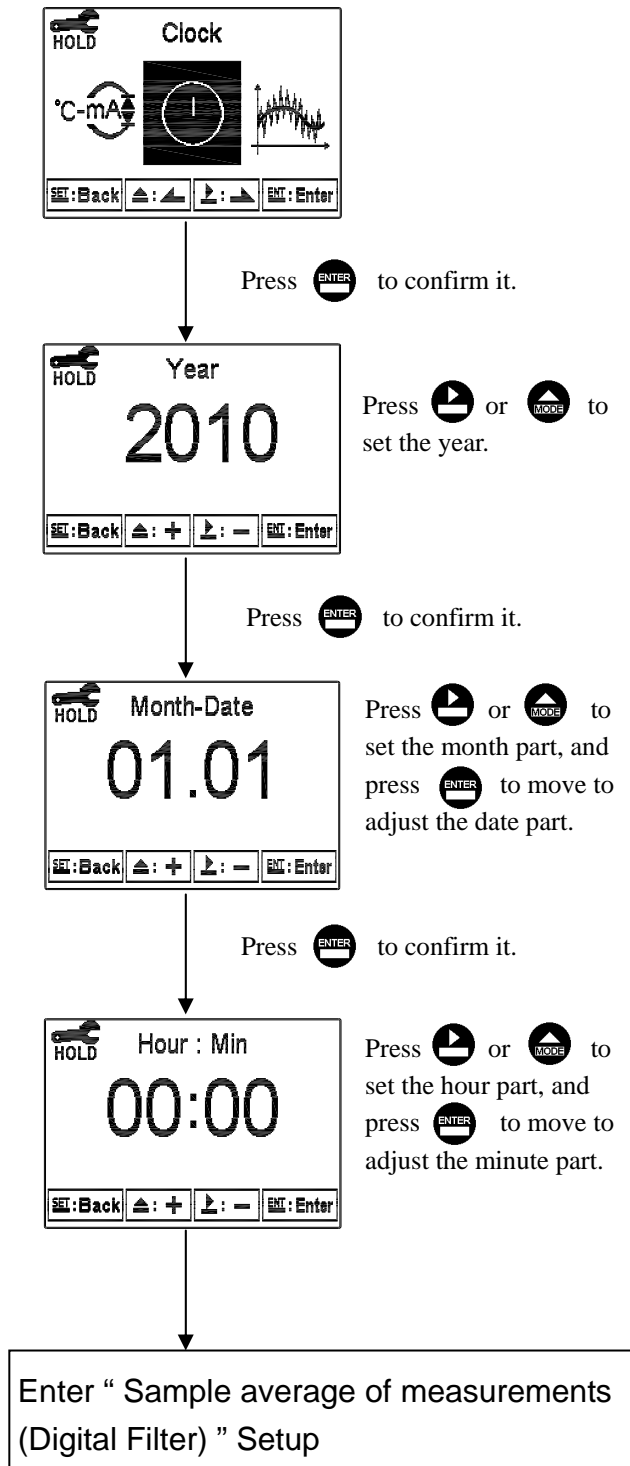

6.12 Sample average of measurements (Digital Filter)

Enter the setup of Digital filter. You may select the number of sample to be averaged each time to become a reading which is gradually counted in order to increase the stability of measurement.

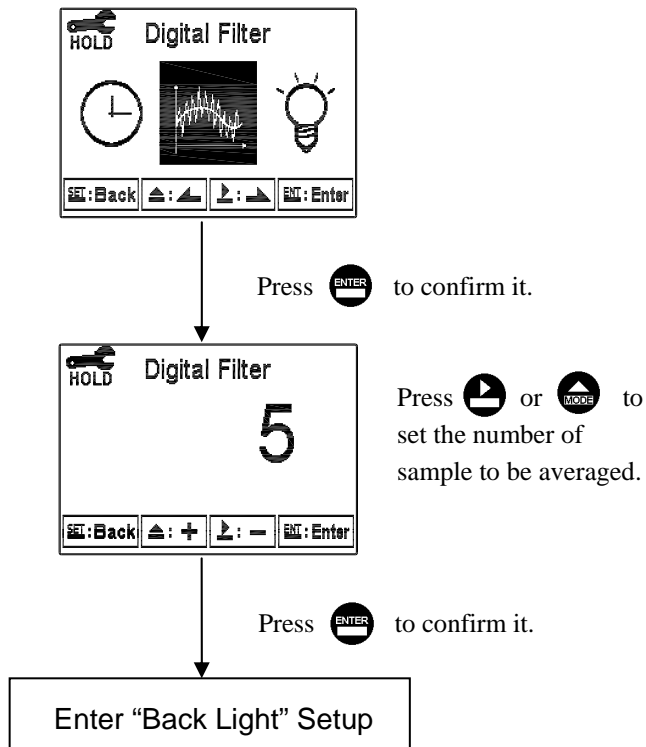

6.13 Backlight settings

Enter setup of backlight display. According to your need, you can set the brightness of display and sensitivity of the sensitization sensor.

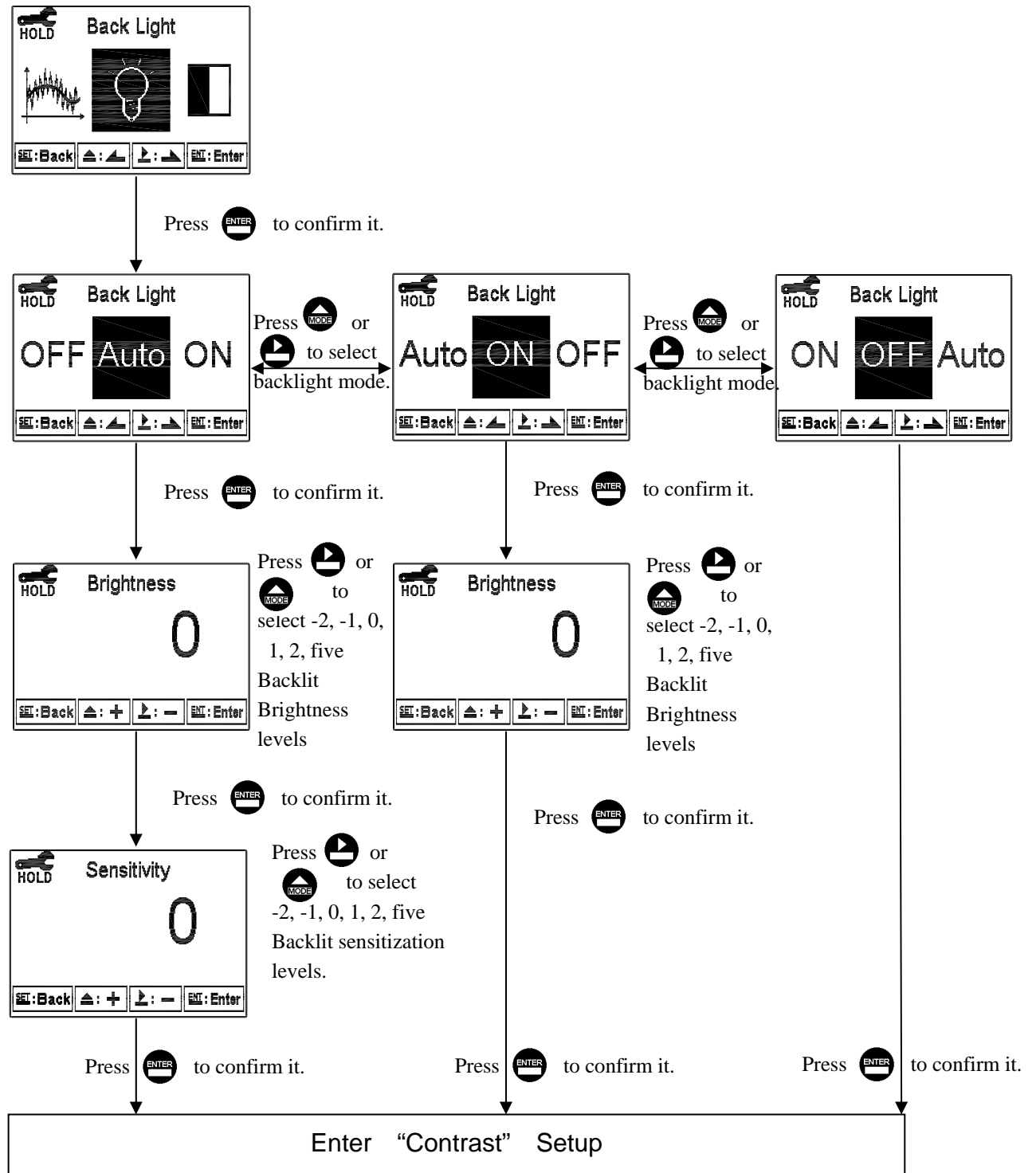

6.14 Contrast settings

Enter setup of display contrast. You can set the contrast of display according to your need.

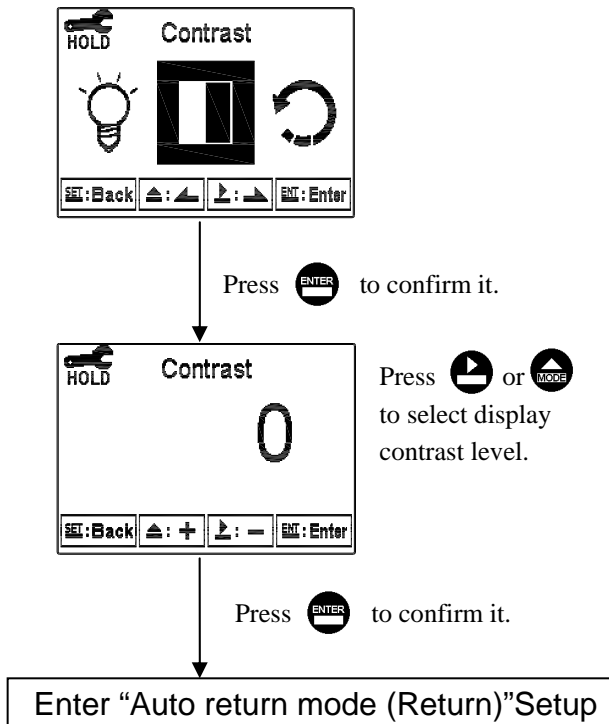

6.15 Return

Enter setup of auto return mode (Return) to set the function that the instrument automatically exit the setup menu after a period of time without pressing any key. The “Manual Exit” means that it needs to exit setup menu manually, while “Auto” means that the display automatically exit the setup menu and back to measurement mode after a period of time without pressing any key.

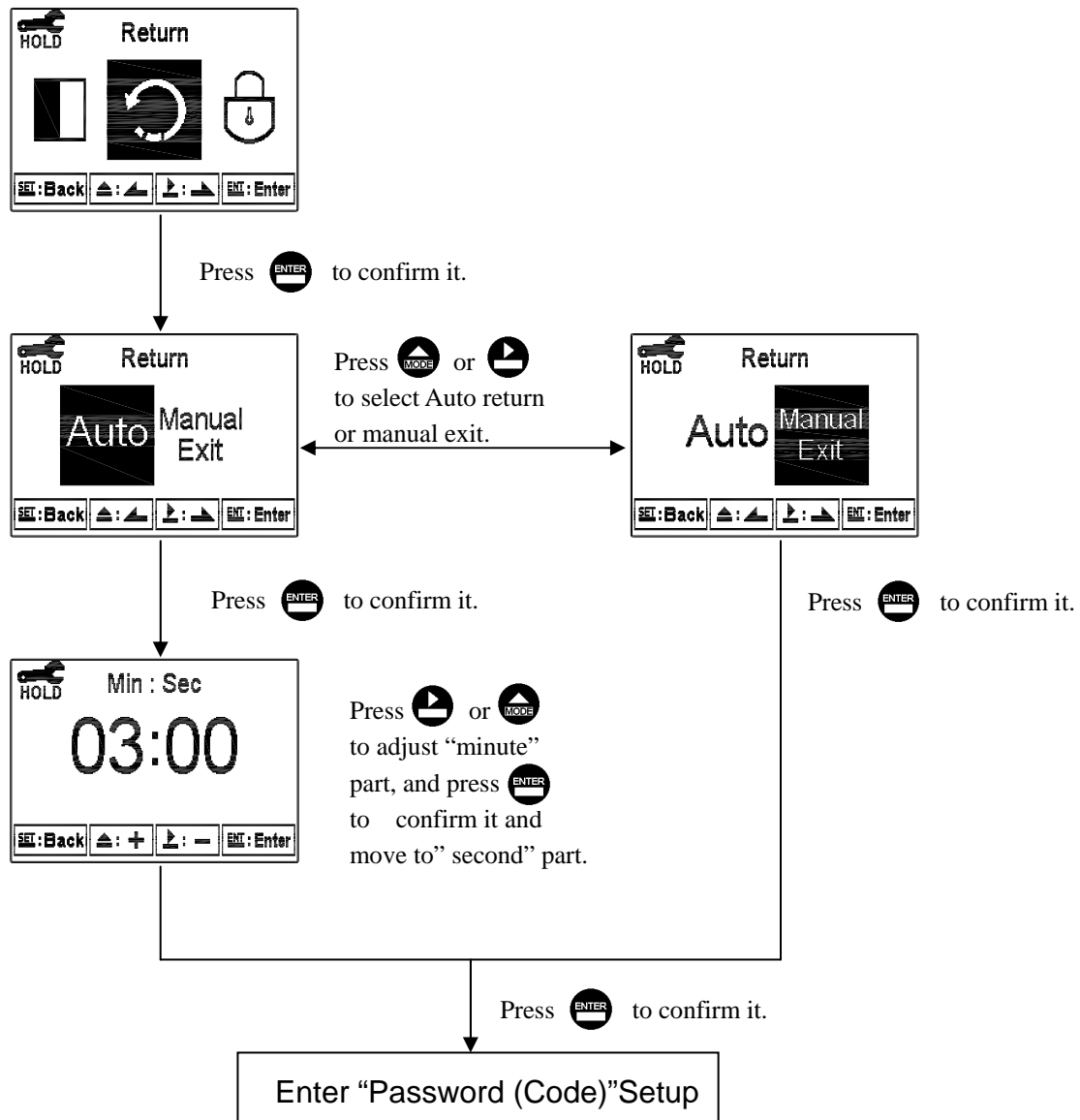

7. Calibration

Block diagram of Calibration

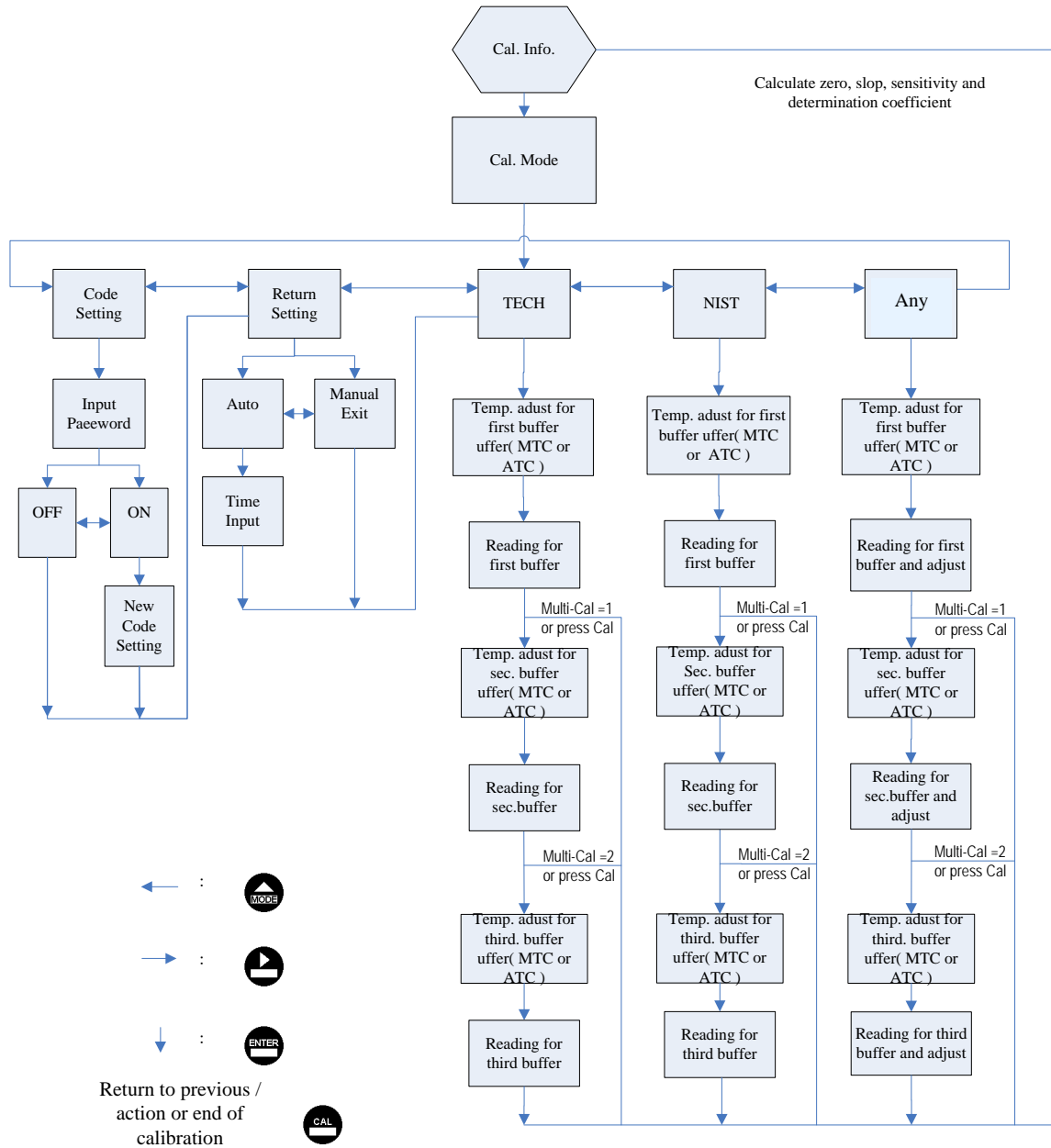

7.1 Enter calibration setup menu

In the measurement mode, pressing the two keys **CAL** and **MODE** simultaneously allows you enter the Calibration Information. If you do not need to re-calibrate the measurement system, press **CAL** to go back to measurement mode. If you need to re-calibrate the system, press **ENTER** to enter to the calibration setup menu.

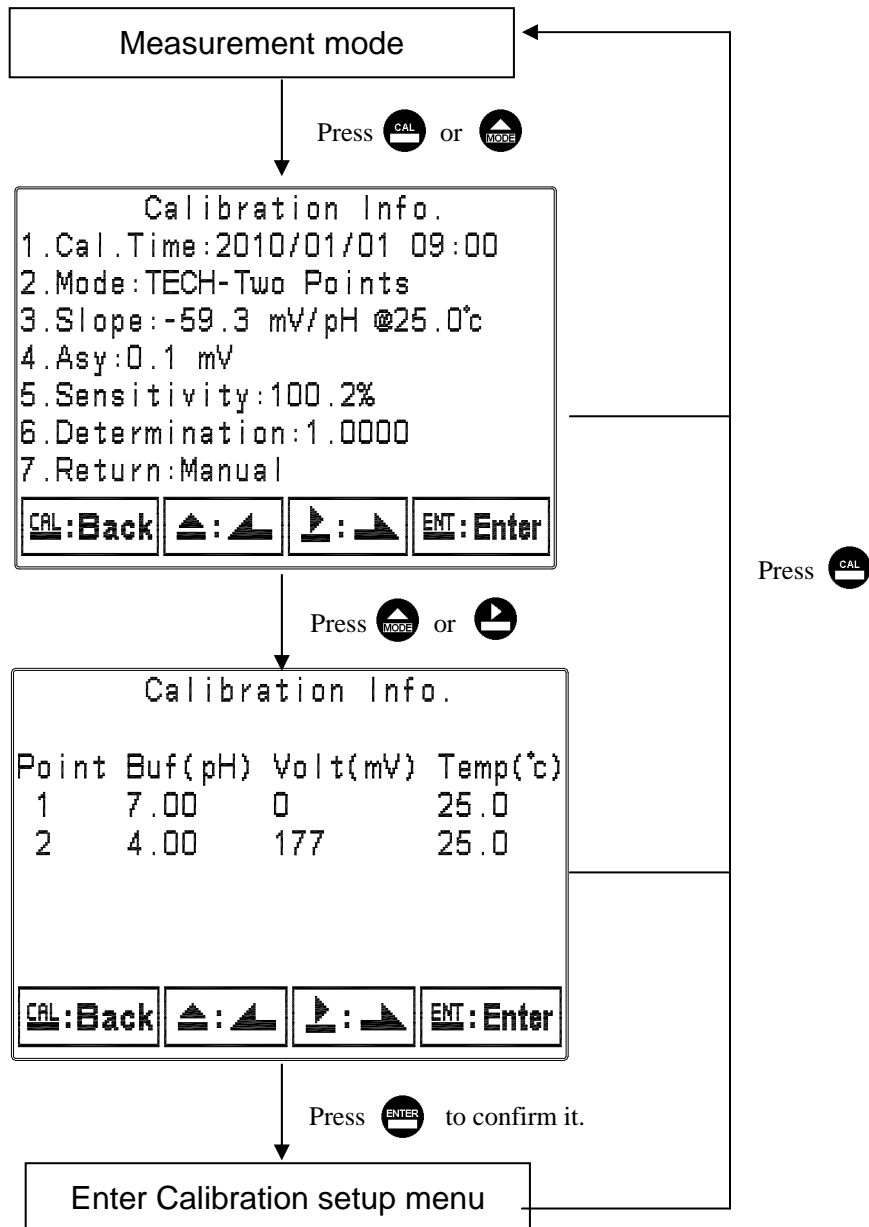

7.2 Security password of calibration (Code)

Select the Code (password) icon after entering calibration setup mode. Select to activate code function or not. The default Calibration setting code is “1100”.

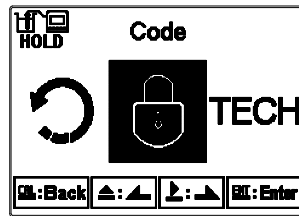

Press to confirm it.

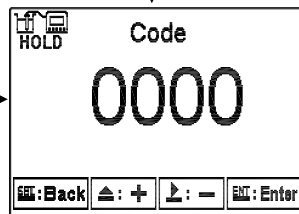

The first '0' of digits '0000' start to twinkle. Press or to adjust the value, and then press to confirm it and continually key in the next digit, and so on.

Press to confirm it.

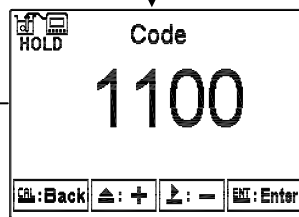

If you input a wrong code, then the display shows a “Error 5” message. Press to restart inputting another code, or press to exit the calibration menu.

If you input a wrong code, then the display shows a “Error 5” message. Press to restart inputting another code, or press to exit the calibration menu.

(Select to turn on or turn off code protection function. If you select turn on, please key in a new code. There will be a code requirement showing in display when you re-enter to the setup mode. Key in the correct password to enter into calibration setup menu.)

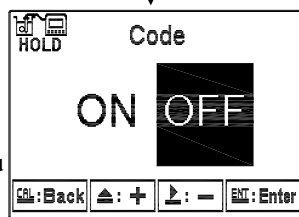

Press or

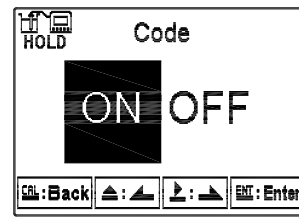

Press to confirm it.

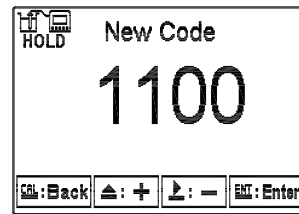

Input new code

Press to confirm it.

Enter “Auto return mode (Return)”Setup

7.3 Return

Enter setup of auto return mode (Return) to set the function that the instrument automatically exit the setup menu after a period of time without pressing any key. The “Manual Exit” means that it needs to exit calibration setup menu manually, while “Auto” means that the display automatically exit the calibration setup menu and back to measurement mode after a period of time without pressing any key.

Note: the return function of setup menu and calibration setup menu are independent settings.

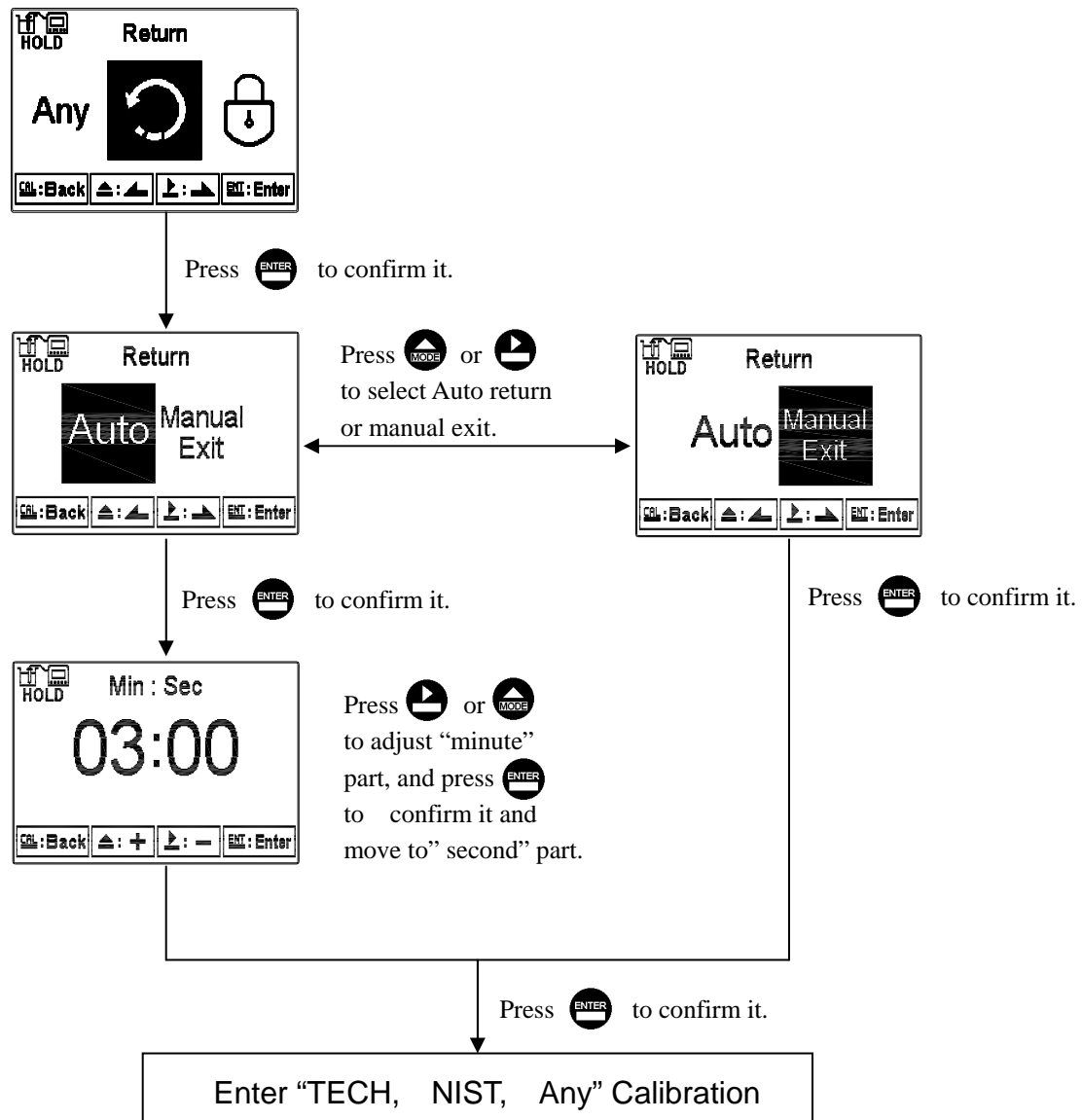

7.4 pH Calibration

The instrument provides multi-point standard buffer solution calibration. You may decide how many points to calibrate the measurement system (up to 3-point). The principle is according to “Method of Least Squares”. Apply linear regression to calibration the electrode’s slope and zero point (Asy, Offset or Zero point).

When calibrating a electrode, you may calibrate 1 to 3 point by any sequence to provide linear regression for mV and pH multi-calibration of a electrode, and to show the electrode’s slope and zero point (Asy, offset or Zero point) at 25°C. The electrode’s slope rate which is actual slope divided by theoretical slope and the sensitivity shows in percentage in the display. In addition, the display shows the linear regression determination coefficient, R², of the electrode and buffer solution to provide you an estimation of an electrode’s regression suitability. According to different combination of standard buffers, the TECH, NIST, Any buffer solution calibration modes are provided.

7.4.1 TECH mode (Up to 3-point calibration)

The electrode is automatically calibrated according to pH value and temperature of TECH standard buffers. The range of zero point and slope of the electrode is also determined. If one of them is over the range, the display shows error message of zero point and slope failure. (See appendix Table 1, pH/temperature table of TECH standard buffers)

7.4.2 NIST mode (Up to 3-point calibration)

The electrode is automatically calibrated according to pH value and temperature of NIST standard buffers. The range of zero point and slope of the electrode is also determined. If one of them is over the range, the display shows error message of zero point and slope failure. (See appendix Table 2, pH/temperature table of NIST standard buffers)

7.4.3 Any mode (Up to 3-point calibration)

The electrode measures mV value of different standard solutions. According to theoretic slope and the temperature of standard solutions, the display shows a approximate pH value. Then, you can calibrate the electrode by freely adjust the pH value as those of the standard solutions’. There is not a zero point range failure determination by the instrument but only the slope range determination. If the slope is over the range, the display shows error message of slope failure.

7.4.4 Definition of calibration parameter

You can calibrate the electrode by one point or up to three points of standard solutions by any sequence. As different calibration point method is applied, the definition of the zero point and slope different.

Calibration point	Determination	The showed calibration value
One point calibration	Asy	Zero point (Asy, offset or Zero point)= Asy 1.If not calibrated, Slope = Theoretical slope 2.If calibrated, Slope = Slope of last calibration
Two or three point calibration	Asy Slope	Zero point (Asy, offset or Zero point)= Asy Slope = Slope* Note: To obtain a new zero point(Asy) and Slope by applying linear regression.

7.4.5 TECH, NIST buffer Calibration

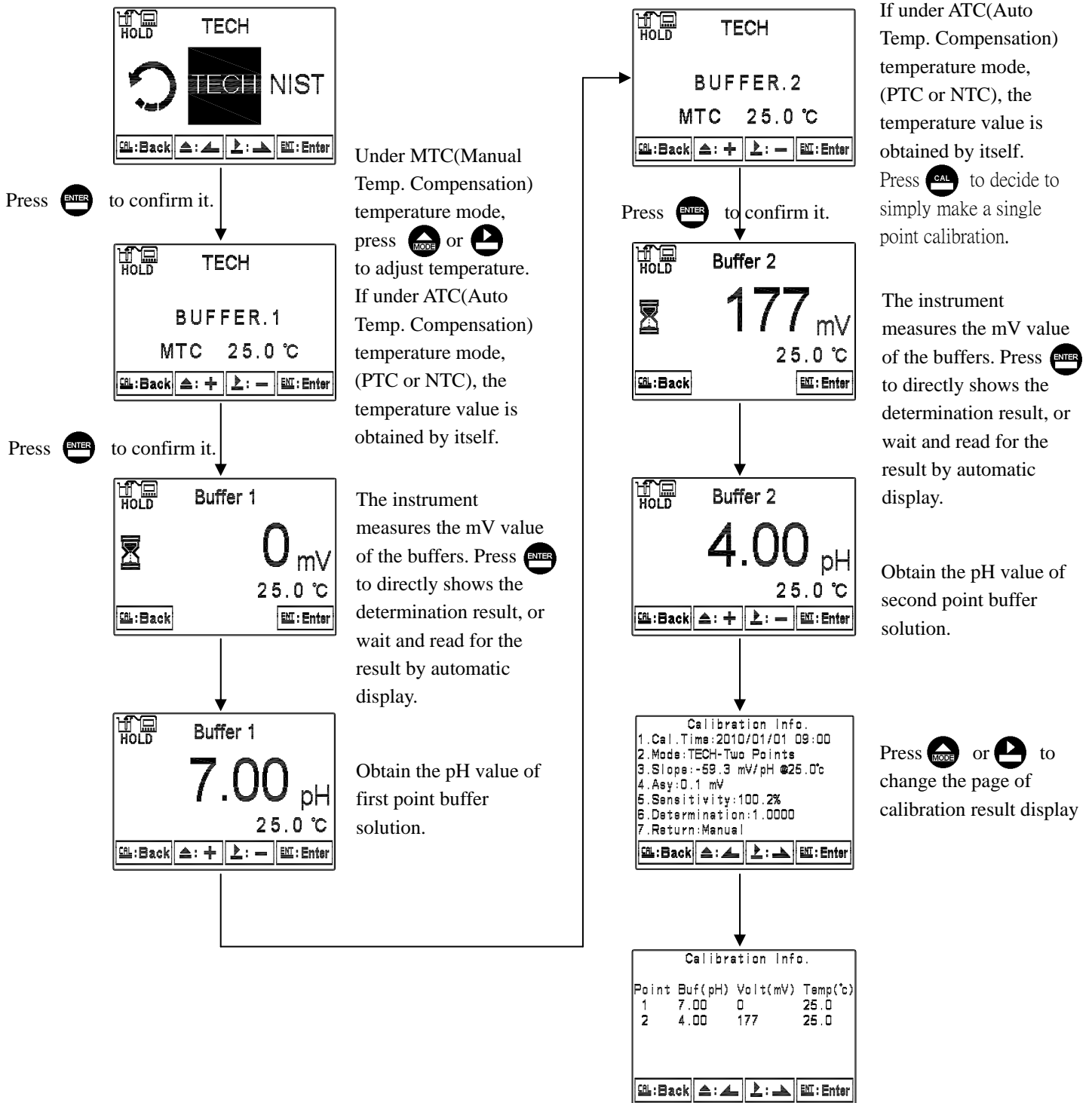

The procedure below is two points calibration of TECH buffer. (The procedure is same as NIST buffer mode.) First, enter the setup of Multi-points calibration and set the number of calibration point for 2. (See chapter 6.4 Multi-Cal) Then, go to Calibration menu and select TECH mode. Operate the instrument as follow procedure diagram.

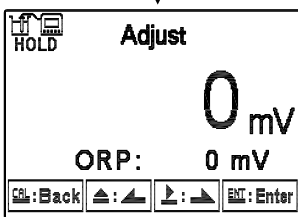
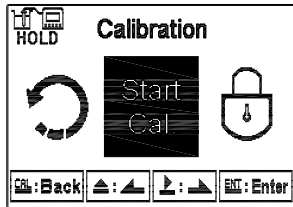

7.5 ORP Calibration

Under ORP measurement mode, enter calibration setup menu. Select Calibration icon, and adjust mV value. The adjustable range is from -300mV to 300mV.



Put the ORP electrode into ORP standard solution. Press  or  to adjust the main display value until it is equal to the desirable mV value.

Press  to confirm it.

8. Error messages (Error code)

Messages	Reason	Dispositions
Error9	Serious error that does not permit any further measuring	Please call service engineer.
Error4	<ol style="list-style-type: none"> 1. During calibration, the buffer solution temperature exceeds a range of 5~50°C 2. The buffer can not be identified. 	<ol style="list-style-type: none"> 3. Please adjust the buffer solution temperature to the appropriate temperature range and make another calibration. 4. Please replace the buffer, or maintain or replace the electrode and make another calibration.
Error3	The readout is unstable	Please check whether there is bubble or air in the glass end of the electrode; maintain the electrode or change a new electrode, and make another calibration.
Error2	SLOPE value exceeds the upper or lower limit	Maintain the electrode or change a new electrode, and make another calibration.
Error1	OFFSET(zero-point electric potential) value \geq 60mv	Maintain the electrode or replace the electrode, and make another calibration.

9. Maintenance

Generally speaking, under normal operation, the controller produced by our company need no maintenance expect regular cleaning and calibration of the electrode to ensure accurate and stable measurement and system operation.

The cleaning cycle for the electrode depends on the pollution degree of the measurement sample. Generally speaking, it is recommended to make weekly cleaning. The following chart gives introductions of different cleaning methods according to different type of contaminations to provide the operators with reference for cleaning and maintenance.

Type of Contaminations	Cleaning methods
Measuring solutions containing proteins. (Contamination of the junction)	The electrode should be soaked in Pepsin/HCl for several hours. METTLER-TOLEDO 9891 Electrode Cleaner is recommended.
Measuring solution containing sulfides. (The junction becomes black)	The junction should be soaked in Thiourea/HCl solution until being bleached. METTLER-TOLEDO 9892 Electrode Cleaner is recommended.
Contamination by grease or organic substance	Short rinsing of the electrode with acetone and ethanol.
Acid and alkaline soluble contaminations	Rinsing the electrode with 0.1mol/l NaOH or 0.1mol/l HCl for a few minutes.
Apply clean water to flash the electrode after above cleaning steps and immerse the electrode in 3M KCl solution for 15 minutes at least, and then calibrate the electrode.	
The electrode should only be rinsed and never rubbed or otherwise mechanically cleaned, since this would lead to electrostatic charges. This could cause an increase in the response time.	
In cleaning the platinum electrode, the platinum ring of the electrode can be rubbed gently with a wet soft piece of cloth.	

※ **The frequency of electrode cleaning depends on the type and degree of contamination. However it is recommended that the electrode be cleaned once a week.**

Appendix

Table 1

TECH Mode	TECH buffers		
TEMP°C	Buffer 4.01	Buffer 7	Buffer 10
5	3.999	7.087	10.241
10	3.998	7.053	10.155
15	3.999	7.031	10.116
20	4.002	7.011	10.047
25	4.006	6.996	9.998
30	4.011	6.985	9.952
35	4.018	6.976	9.925
40	4.031	6.971	9.874
45	4.047	6.969	9.843
50	4.055	6.969	9.810

Table

NIST Mode	NIST standard buffers(DIN 19266)				
TEMP°C	Buffer 1.68	Buffer 4.01	Buffer 6.86	Buffer 9.18	Buffer 12.45
5	1.668	4.004	6.951	9.395	13.207
10	1.670	4.000	6.923	9.332	13.003
15	1.672	3.999	6.900	9.276	12.810
20	1.675	4.001	6.881	9.225	12.627
25	1.679	4.006	6.865	9.180	12.454
30	1.683	4.012	6.853	9.139	12.289
35	1.688	4.021	6.844	9.102	12.133
40	1.694	4.031	6.838	9.068	11.984
45	1.700	4.043	6.834	9.038	11.410
50	1.707	4.057	6.833	9.011	11.705



SUNTEX INSTRUMENTS CO., LTD.

13F, No. 31, Lane 169, Kangning St.,
Xizhi Dist., New Taipei City, Taiwan (R.O.C.)
Tel: 886-2-2695-9688
Fax: 886-2-2695-9693
e-mail: suntex@ms1.hinet.net

www.suntex.com.tw/en/index.asp