

2010  
2010  
2010  
eutech instruments  
catalogue

a spectrum of  
products for your  
water testing needs

SOLUTIONS FOR WATER ANALYSIS

**EUTECH**  
**INSTRUMENTS**  
*Technology Made Easy ...*



## A New Range of Bench Meters with BIGGER Screens that Says More!

### Eutech 2700 Series

Intuitive with advanced set-up options for user-customization, the Eutech 2700 series comes with a large, one-glance-tells-all screen that displays readings, electrode status, calibration points, date and time all at once!

- Ion 2700 measures pH, Ion, ORP and Temperature | [Page 29](#) |
- pH 2700 measures pH, ORP, Temperature | [Page 30](#) |
- CON 2700 measures Conductivity, Resistivity, Total Dissolved Solids, Salinity and Temperature | [Page 51](#) |
- DO 2700 measures Dissolved Oxygen (in % Saturation and mg/L) and Temperature – with BOD capabilities! | [Page 65](#) |
- PC 2700 measures pH, ORP, Conductivity, Resistivity, Total Dissolved Solids, Salinity and Temperature | [Page 81](#) |

### Eutech 700 Series

Accurate, user-friendly and very affordable! The new Eutech 700 series integrates signature Eutech features and comes with a large, multi-data screen – giving you a better view of what's happening in your beaker from all angles!

- Ion 700 measures pH, Ion, ORP and Temperature | [Page 31](#) |
- pH 700 measures pH, ORP, Temperature | [Page 32](#) |
- CON 700 measures Conductivity, Total Dissolved Solids, Salinity and Temperature | [Page 52](#) |
- DO 700 measures Dissolved Oxygen (in % Saturation and mg/L) and Temperature | [Page 66](#) |
- PC 700 measures pH, ORP, Conductivity, Total Dissolved Solids, Salinity and Temperature | [Page 82](#) |



pH 700

DO 2700

CON 700

PC 2700



Temp 360

Temp 300

Temp 10K

### Thermo Scientific Handheld Thermometers

Rugged, robust and reliable with an ergonomic design to fit firmly in your palm while you work. The Thermo Scientific Temp series offers a vast selection of versatile instruments for your temperature measurement needs, whether your application calls for a standard thermometer, an advanced datalogging model or anything in between. Available for thermocouple | [Page 94, 95](#) | and RTD measurements | [Page 93, 95](#) |.



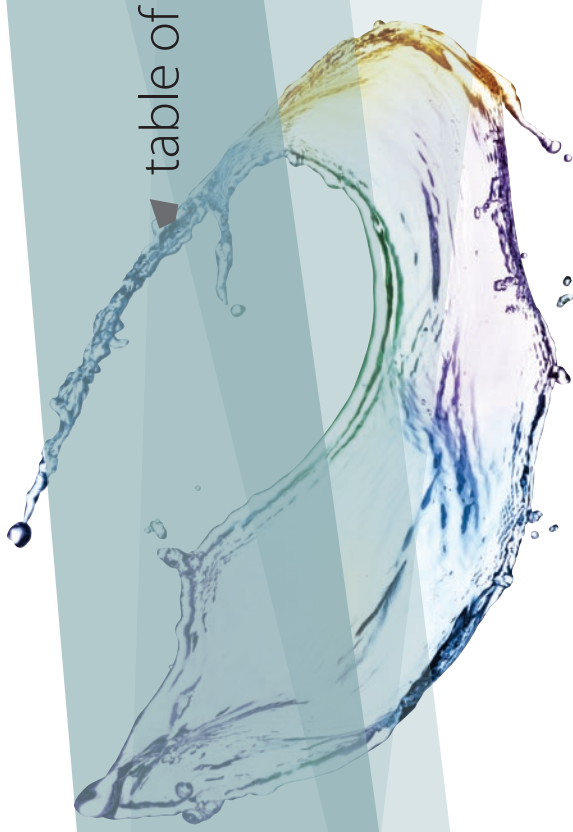

**004 Meter Selection Guide**

- 004 pH Meter Quick Guide
- 005 Conductivity Meter Quick Guide
- 006 Total Dissolved Solids Meter Quick Guide
- 007 Salinity Meter Quick Guide
- 008 Dissolved Oxygen Meter Quick Guide
- 009 Multi-Parameter Meter Quick Guide
- 012 Colorimeter Quick Guide & Feature Icons

**013 pH/ORP**

- 014 About pH/ORP Measurement
- 016 pHTestr® 30; 20; 10
- 017 EcoTestr pH 2
- 018 pHTestr® 10BNC; pH Spear
- 019 ORPTestr® 10; 10BNC
- 020 Pocket Testers Specs
- 021 Pocket Testers Ordering Info
- 022 CyberScan pH 620; 610; 600
- 023 CyberScan pH 310; 300
- 024 CyberScan pH 110; 11
- 025 Ion 6+; pH 6+; 5+
- 026 Handheld Meters Specs
- 027 Handheld Meters Ordering Info
- 028 CyberScan pH 6500; pH 6000
- 029 Ion 2700
- 030 pH 2700
- 031 Ion 700
- 032 pH 700
- 033 Bench Meters Specs
- 034 Bench Meters Ordering Info

**035 Conductivity/TDS/Salinity**

- 036 About Conductivity/TDS/Salinity Measurement
- 038 ECTestr 11+; 11 & TDSTestr® 11+; 11
- 039 SaltTestr® 11
- 040 EcoTestr EC High/Low; TDS High/Low; Salt
- 041 Pocket Testers Specs
- 042 Pocket Testers Ordering Info
- 043 CyberScan COND 610; 600
- 044 CyberScan CON 400
- 045 CyberScan CON 110; 11
- 046 COND 6+; TDS 6+
- 047 Salt 6+
- 048 Handheld Meters Specs
- 049 Handheld Meters Ordering Info
- 050 CyberScan CON 6000
- 051 CON 2700
- 052 CON 700
- 053 Bench Meters Specs
- 054 Bench Meters Ordering Info

**055 Dissolved Oxygen**

- 056 About Dissolved Oxygen Measurement
- 058 CyberScan DO 600
- 059 CyberScan DO 300
- 060 CyberScan DO 110
- 061 DO 6+
- 062 Handheld Meters Specs

- 063 Handheld Meters Ordering Info
- 064 CyberScan DO 6000
- 065 DO 2700
- 066 DO 700
- 067 Bench Meters Specs
- 068 Bench Meters Ordering Info

**069 Multi-Parameter**

- 070 PCSTestr™ 35; PCTestr™ 35; PTTestr™ 35
- 071 Pocket Testers Specs & Ordering Info
- 072 CyberScan PCD 650
- 073 CyberScan PC 650; PD 650; CD 650
- 074 CyberScan PD 300
- 075 CyberScan PC 300; 10
- 076 Handheld Meters Specs
- 078 Handheld Meters Ordering Info
- 079 CyberScan PCD 6500
- 080 CyberScan PC 6500; PC 6000
- 081 PC 2700
- 082 PC 700
- 083 Bench Meters Specs
- 084 Bench Meters Ordering Info

**085 Turbidity & Colorimetry**

- 086 About Turbidity/Colorimetric Measurement
- 087 CyberScan TB 1000; TN 100
- 088 Turbidity Meters Specs & Ordering Info
- 089 C 401; C 301; C 201; C 105; C 103 Colorimeters
- 090 Colorimeters Specs & Ordering Info

**091 Temperature**

- 092 About Temperature Measurement
- 093 Thermo Scientific Temp 360
- 094 Thermo Scientific Temp 300
- 095 Thermo Scientific Temp 10 Series
- 096 Handheld Meters Specs
- 097 EcoScan Temp JKT, 6, 5
- 098 Handheld Meters Specs & Ordering info

**099 Electrode**

- 100 About pH Electrodes
- 103 Electrode Maintenance Guide
- 104 pH Electrodes (General Glass & General Plastic)
- 105 pH Electrodes (Specialty)
- 106 pH Electrodes (3-in-1), ORP Electrodes
- 107 Conductivity Electrodes, DO Electrodes
- 108 ATC Probes, Temperature Probes

**109 Accessories**

- 110 Buffer & Calibration Solutions; Soft Carrying Case for Waterproof Testers
- 111 Calibration Sachets; Buffer Tablets; Precision pH Simulator; Electrode Stand with Swivel Arm
- 112 CyberComm 6000 21 CFR Part 11 Application Software; USB IrDA Adapter; RS232C (LED) Interface Adapter; RS232C Microprinters

*A colour spectrum caught in a splash of water – represents the many ways which clean water brings colours to people's life, made possible by Eutech's products.*

**Meter Selection Guide**  
pH Meter Quick Guide

# Meter Selection Guide

## pH Meter Quick Guide



Models	Parameters	pH Range	Accuracy	Cal. Points	pH Buffer Sets	GLP	Memory	Temperature Display	Housing Rating	Communication	Page No.
<b>Pocket Testers</b>											
PCSTestr 35	pH/Conductivity/TDS/Salinity/°C/°F	0.00 to 14.00 pH	±0.01 pH	5	USA, NIST	–	–	Yes	IP67	–	<b>Pg 70</b>
PCTestr 35	pH/Conductivity/°C/°F	0.0 to 14.0 pH	±0.1 pH	5	USA, NIST	–	–	Yes	IP67	–	<b>Pg 70</b>
PTTestr 35	pH/TDS/°C/°F	0.0 to 14.0 pH	±0.1 pH	5	USA, NIST	–	–	Yes	IP67	–	<b>Pg 70</b>
pHTestr 30	pH/°C/°F	-1.00 to 15.00 pH	±0.01 pH	3	USA, NIST	–	–	Yes	IP67	–	<b>Pg 16</b>
pHTestr 20	pH	-1.00 to 15.00 pH	±0.01 pH	3	USA, NIST	–	–	–	IP67	–	<b>Pg 16</b>
pHTestr 10	pH	-1.0 to 15.0 pH	±0.1 pH	3	USA, NIST	–	–	–	IP67	–	<b>Pg 16</b>
EcoTestr pH 2	pH	0.0 to 14.0 pH	±0.1 pH	3	USA, NIST	–	–	–	IP67	–	<b>Pg 17</b>
pHTestr 10BNC	pH/°C/°F	-1.00 to 15.00 pH	±0.01 pH	3	USA, NIST	–	–	Yes	IP67	–	<b>Pg 18</b>
pH Spear	pH/°C/°F	-1.00 to 15.00 pH	±0.01 pH	3	USA, NIST	–	–	Yes	IP67	–	<b>Pg 18</b>
<b>Handheld Meters</b>											
CyberScan PCD 650	pH/ORP/Ion/Conductivity/TDS/Salinity/Resistivity/Dissolved Oxygen/°C/°F	-2.000 to 20.000 pH	±0.002 pH	6	USA, NIST, DIN, PWB, Custom	Yes	500	Yes	IP67	LED RS232C, IrDA	<b>Pg 72</b>
CyberScan PC 650	pH/ORP/Ion/Conductivity/TDS/Salinity/Resistivity/°C/°F	-2.000 to 20.000 pH	±0.002 pH	6	USA, NIST, DIN, PWB, Custom	Yes	500	Yes	IP67	LED RS232C, IrDA	<b>Pg 73</b>
CyberScan PD 650	pH/ORP/Ion/Dissolved Oxygen/°C/°F	-2.000 to 20.000 pH	±0.002 pH	6	USA, NIST, DIN, PWB, Custom	Yes	500	Yes	IP67	LED RS232C, IrDA	<b>Pg 73</b>
CyberScan pH 620	pH/ORP/Ion/°C/°F	-2.000 to 20.000 pH	±0.002 pH	6	USA, NIST, DIN, PWB, Custom	Yes	500	Yes	IP67	LED RS232C, IrDA	<b>Pg 22</b>
CyberScan pH 610	pH/ORP/°C/°F	-2.000 to 20.000 pH	±0.002 pH	6	USA, NIST, DIN, PWB, Custom	Yes	500	Yes	IP67	LED RS232C, IrDA	<b>Pg 22</b>
CyberScan pH 600	pH/ORP/°C/°F	-2.00 to 20.00 pH	±0.01 pH	6	USA, NIST, DIN, PWB, Custom	Yes	500	Yes	IP67	LED RS232C, IrDA	<b>Pg 22</b>
CyberScan pH 310	pH/ORP/°C/°F	-2.00 to 16.00 pH	±0.01 pH	6	USA, NIST, DIN	Yes	50	Yes	IP67	–	<b>Pg 23</b>
CyberScan pH 300	pH/ORP/°C	-2.00 to 16.00 pH	±0.01 pH	5	USA	–	16	Yes	IP67	–	<b>Pg 23</b>
CyberScan pH 110	pH/ORP/°C/°F	-2.00 to 16.00 pH	±0.01 pH	6	USA, NIST, DIN, PWB	–	100	Yes	IP54	RS232C	<b>Pg 24</b>
CyberScan pH 11	pH/ORP/°C	-2.00 to 16.00 pH	±0.01 pH	5	USA, NIST	–	50	Yes	IP54	–	<b>Pg 24</b>
Ion 6+	Ion/pH/ORP/°C	0.00 to 14.00 pH	±0.01 pH	3	USA, NIST, PWB	–	–	Yes	IP54	–	<b>Pg 25</b>
pH 6+	pH/ORP/°C	0.00 to 14.00 pH	±0.01 pH	3	USA, NIST, PWB	–	–	Yes	IP54	–	<b>Pg 25</b>
pH 5+	pH/°C	0.00 to 14.00 pH	±0.01 pH	3	USA, NIST, PWB	–	–	Yes	IP54	–	<b>Pg 25</b>
<b>Bench Meters</b>											
CyberScan PCD 6500	pH/ORP/Ion/Conductivity/TDS/Salinity/Resistivity/Dissolved Oxygen/BOD/OUR/SOUR/°C/°F	-2.000 to 20.00 pH	±0.002 pH	5	USA, NIST, Euro, Custom	Yes	1000 per parameter	Yes	–	Internet/intranet, RS232C, USB, IrDA, SD card	<b>Pg 79</b>
CyberScan PC 6500	pH/ORP/Ion/Conductivity/TDS/Salinity/Resistivity/°C/°F	-2.000 to 20.00 pH	±0.002 pH	5	USA, NIST, Euro, Custom	Yes	1000 per parameter	Yes	–	Internet/intranet, RS232C, USB, IrDA, SD card	<b>Pg 80</b>
CyberScan PC 6000	pH/ORP/Conductivity/TDS/Salinity/Resistivity/°C/°F	-2.000 to 20.00 pH	±0.002 pH	5	USA, NIST, Euro, Custom	Yes	1000 per parameter	Yes	–	Internet/intranet, RS232C, USB, IrDA, SD card	<b>Pg 80</b>
PC 2700	pH/ORP/Ion/Conductivity/TDS/Salinity/Resistivity/°C/°F	-1.999 to 19.999 pH	±0.002 pH	6	USA, NIST, Euro, Custom	Yes	500	Yes	–	RS232C	<b>Pg 81</b>
PC 700	pH/ORP/Conductivity/TDS/°C/°F	0.00 to 14.00 pH	±0.01 pH	5	USA, NIST	–	100	Yes	–	–	<b>Pg 82</b>
CyberScan pH 6500	pH/ORP/Ion/°C/°F	-2.000 to 20.000 pH	±0.002 pH	5	USA, NIST, Euro, Custom	Yes	1000 per parameter	Yes	–	Internet/intranet, RS232C, USB, IrDA, SD card	<b>Pg 28</b>
CyberScan pH 6000	pH/ORP/°C/°F	-2.000 to 20.000 pH	±0.002 pH	5	USA, NIST, Euro, Custom	Yes	1000 per parameter	Yes	–	Internet/intranet, RS232C, USB, IrDA, SD card	<b>Pg 28</b>
Ion 2700	pH/ORP/Ion/°C/°F	-1.999 to 19.999 pH	±0.002 pH + 1 LSD	6	USA, NIST, DIN, User 1, User 2, Custom	Yes	500	Yes	–	RS232C	<b>Pg 29</b>
pH 2700	pH/ORP/°C/°F	-1.999 to 19.999 pH	±0.002 pH + 1 LSD	6	USA, NIST, Custom	Yes	500	Yes	–	RS232C	<b>Pg 30</b>
Ion 700	pH/ORP/Ion/°C/°F	0.00 to 14.00 pH	±0.01 pH + 1 LSD	5	USA, NIST	–	100	Yes	–	–	<b>Pg 31</b>
pH 700	pH/ORP/°C/°F	0.00 to 14.00 pH	±0.01 pH + 1 LSD	5	USA, NIST	–	100	Yes	–	–	<b>Pg 32</b>





## Conductivity Meter Quick Guide

Models	Parameters	Conductivity Range	Accuracy	Cal. Points	GLP	Memory	Temperature Display	Housing Rating	Communication	Page No.
<b>Pocket Testers</b>										
PCSTestr 35	pH/Conductivity/TDS/Salinity/°C/°F	.. to 200.0 µS 200 to 2000 µS 2.00 to 20.00 mS	±1 % full scale	3 auto 3 manual	-	-	Yes	IP67	-	Pg 70
PCTestr 35	pH/Conductivity/°C/°F	.. to 2000 µS 2.00 to 20.00 mS	±1 % full scale	2 auto 2 manual	-	-	Yes	IP67	-	Pg 70
ECTestr 11+	Conductivity/°C/°F	.. to 200.0 µS .. to 2000 µS .. to 20.00 mS	±1 % full scale	3 auto 3 manual	-	-	Yes	IP67	-	Pg 38
ECTestr 11	Conductivity/°C/°F	.. to 2000 µS .. to 20.00 mS	±1 % full scale	2 auto 2 manual	-	-	Yes	IP67	-	Pg 38
EcoTestr EC High	Conductivity	.. to 19.90 mS	±1 % full scale (±2 % above 10 mS)	1	-	-	-	IP67	-	Pg 40
EcoTestr EC Low	Conductivity	.. to 1990 µS	±1 % full scale	1	-	-	-	IP67	-	Pg 40
<b>Handheld Meters</b>										
CyberScan PCD 650	pH/ORP/Ion/ Conductivity/TDS/ Salinity/Resistivity/ Dissolved Oxygen/°C/°F	.. to 2.000 µS 2.000 to 300.0 µS 300.0 µS to 4.000 mS 4.000 to 40.00 mS 40.00 to 500.0 mS	±1 % full scale + 1 LSD	4 auto 5 manual	Yes	500	Yes	IP67	LED RS232C, IrDA	Pg 72
CyberScan PC 650	pH/ORP/Ion/ Conductivity/TDS/ Salinity/Resistivity/°C/°F	.. to 2.000 µS 2.000 to 300.0 µS 300.0 µS to 4.000 mS 4.000 to 40.00 mS 40.00 to 500.0 mS	±1 % full scale + 1 LSD	4 auto 5 manual	Yes	500	Yes	IP67	LED RS232C, IrDA	Pg 73
CyberScan CD 650	Conductivity/TDS/ Salinity/Resistivity/ Dissolved Oxygen/°C/°F	.. to 2.000 µS 2.000 to 300.0 µS 300.0 µS to 4.000 mS 4.000 to 40.00 mS 40.00 to 500.0 mS	±1 % full scale + 1 LSD	4 auto 5 manual	Yes	500	Yes	IP67	LED RS232C, IrDA	Pg 73
CyberScan COND 610	Conductivity/TDS/ Salinity/Resistivity/°C/°F	.. to 2.000 µS 2.000 to 300.0 µS 300.0 µS to 4.000 mS 4.000 to 40.00 mS 40.00 to 500.0 mS	±1 % full scale	4 auto 5 manual	Yes	500	Yes	IP67	LED RS232C, IrDA	Pg 43
CyberScan COND 600	Conductivity/TDS/°C/°F	.. to 2.000 µS 2.000 to 300.0 µS 300.0 µS to 4.000 mS 4.000 to 40.00 mS 40.00 to 200.0 mS	±1 % full scale	4 auto 5 manual	Yes	500	Yes	IP67	LED RS232C, IrDA	Pg 43
CyberScan CON 400	Conductivity/TDS/°C/°F	.. to 199.9 mS	±1 % full scale	5	Yes	50	Yes	IP67	-	Pg 44
CyberScan CON 110	Conductivity/TDS/°C/°F	.. to 199.9 mS	±1 % full scale	4 auto 5 manual	-	100	Yes	IP54	RS232C	Pg 45
CyberScan CON 11	Conductivity/TDS/°C	.. to 199.9 mS	±1 % full scale	4 auto 5 manual	-	50	Yes	IP54	-	Pg 45
COND 6+	Conductivity/°C	.. to 199.9 mS	±1 % full scale	4 auto 5 manual	-	-	Yes	IP54	-	Pg 46
<b>Bench Meters</b>										
CyberScan PCD 6500	pH/ORP/Ion/Conductivity/ TDS/Salinity/Resistivity/ Dissolved Oxygen/BOD/ OUR/SOUR/°C/°F	.. to 500 mS	0.5 % full scale + LSD	5	Yes	1000 per parameter	Yes	-	Internet/intranet, RS232C, USB, IrDA, SD card	Pg 79
CyberScan PC 6500	pH/ORP/Ion/ Conductivity/TDS/ Salinity/Resistivity/°C/°F	.. to 500 mS	0.5 % full scale + LSD	5	Yes	1000 per parameter	Yes	-	Internet/intranet, RS232C, USB, IrDA, SD card	Pg 80
CyberScan PC 6000	pH/ORP/Conductivity/ TDS/ Salinity/Resistivity/ °C/°F	.. to 500 mS	0.5 % full scale + LSD	5	Yes	1000 per parameter	Yes	-	Internet/intranet, RS232C, USB, IrDA, SD card	Pg 80
PC 2700	pH/ORP/Ion/ Conductivity/TDS/ Salinity/Resistivity/°C/°F	0.050 µS to 500.0 mS	±1 % full scale	5	Yes	500	Yes	-	RS232C	Pg 81
PC 700	pH/ORP/Conductivity/ TDS/°C/°F	0.0 µS to 200.0 mS	±1 % full scale	5	-	100	Yes	-	-	Pg 82
CyberScan CON 6000	Conductivity/TDS/ Salinity/Resistivity/°C/°F	.. to 500 mS	0.5 % full scale + LSD	5	Yes	1000 per parameter	Yes	-	Internet/intranet, RS232C, USB, IrDA, SD card	Pg 50
CON 2700	Conductivity/TDS/ Salinity/Resistivity/°C/°F	0.050 µS to 500.0 mS	±1 % full scale	5	Yes	500	Yes	-	RS232C	Pg 51
CON 700	Conductivity/TDS/°C/°F	.. µS to 200.0 mS	±1 % full scale	5	-	100	Yes	-	-	Pg 52

## Meter Selection Guide

### Total Dissolved Solids Meter Quick Guide

### Total Dissolved Solids Meter Quick Guide



Models	Parameters	TDS Range	Accuracy	Cal. Points	GLP	Memory	Temperature Display	Housing Rating	Communication	Page No.
<b>Pocket Testers</b>										
PTTestr 35	pH/TDS/°C/°F	100 to 1000 ppm 1.00 to 10.00 ppt	±1 % full scale	2 manual	–	–	Yes	IP67	–	<b>Pg 70</b>
TDSTestr 11+	TDS/°C/°F	.. to 200.0 ppm .. to 2000 ppm .. to 10.00 ppt	±1 % full scale	2	–	–	Yes	IP67	–	<b>Pg 38</b>
TDSTestr 11	TDS/°C/°F	.. to 2000 ppm .. to 10.00 ppt	±1 % full scale	3	–	–	Yes	IP67	–	<b>Pg 38</b>
EcoTestr TDS High	TDS	.. to 10.00 ppt	±1 % full scale (±2 % above 5 ppt)	1	–	–	–	IP67	–	<b>Pg 40</b>
EcoTestr TDS Low	TDS	.. to 1990 ppm	±1 % full scale	1	–	–	–	IP67	–	<b>Pg 40</b>
<b>Handheld Meters</b>										
CyberScan PCD 650	pH/ORP/Ion/ Conductivity/TDS/ Salinity/Resistivity/ Dissolved Oxygen/°C/°F	.. to 2.000 ppm 2.000 to 300.0 ppm 300.0 ppm to 4.000 ppt 4.000 to 40.00 ppt 40.00 to 500.0 ppt	±1 % full scale + 1 LSD	5	Yes	500	Yes	IP67	LED RS232C, IrDA	<b>Pg 72</b>
CyberScan PC 650	pH/ORP/Ion/ Conductivity/TDS/ Salinity/Resistivity/°C/°F	.. to 2.000 ppm 2.000 to 300.0 ppm 300.0 ppm to 4.000 ppt 4.000 to 40.00 ppt 40.00 to 500.0 ppt	±1 % full scale + 1 LSD	5	Yes	500	Yes	IP67	LED RS232C, IrDA	<b>Pg 73</b>
CyberScan CD 650	Conductivity/TDS/ Salinity/Resistivity/ Dissolved Oxygen/°C/°F	.. to 2.000 ppm 2.000 to 300.0 ppm 300.0 ppm to 4.000 ppt 4.000 to 40.00 ppt 40.00 to 500.0 ppt	±1 % full scale + 1 LSD	5	Yes	500	Yes	IP67	LED RS232C, IrDA	<b>Pg 73</b>
CyberScan COND 610	Conductivity/TDS/ Salinity/Resistivity/°C/°F	.. to 2.000 ppm 2.000 to 300.0 ppm 300.0 ppm to 4.000 ppt 4.000 to 40.00 ppt 40.00 to 500.0 ppt	±1 % full scale	5	Yes	500	Yes	IP67	LED RS232C, IrDA	<b>Pg 43</b>
CyberScan COND 600	Conductivity/TDS/°C/°F	.. to 2.000 ppm 2.000 to 300.0 ppm 300.0 ppm to 4.000 ppt 4.000 to 40.00 ppt 40.00 to 200.0 ppt	±1 % full scale	5	Yes	500	Yes	IP67	LED RS232C, IrDA	<b>Pg 43</b>
CyberScan CON 400	Conductivity/TDS/°C/°F	.. to 199.9 ppt *	±1 % full scale	5	Yes	50	Yes	IP67	–	<b>Pg 44</b>
CyberScan CON 110	Conductivity/TDS/°C/°F	.. to 199.9 ppt *	±1 % full scale	5	–	100	Yes	IP54	RS232C	<b>Pg 45</b>
CyberScan CON 11	Conductivity/TDS/°C	.. to 199.9 ppt *	±1 % full scale	5	–	50	Yes	IP54	–	<b>Pg 45</b>
TDS 6+	TDS/°C	.. to 199.9 ppt *	±1 % full scale	5	–	–	Yes	IP54	–	<b>Pg 46</b>
<b>Bench Meters</b>										
CyberScan PCD 6500	pH/ORP/Ion/ Conductivity/TDS/ Salinity/Resistivity/ Dissolved Oxygen/BOD/ OUR/SOUR/°C/°F	.. to 500 ppt	0.5 % full scale + LSD	5	Yes	1000 per parameter	Yes	–	Internet/intranet, RS232C, USB, IrDA, SD card	<b>Pg 79</b>
CyberScan PC 6500	pH/ORP/Ion/ Conductivity/TDS/ Salinity/Resistivity/°C/°F	.. to 500 ppt	0.5 % full scale + LSD	5	Yes	1000 per parameter	Yes	–	Internet/intranet, RS232C, USB, IrDA, SD card	<b>Pg 80</b>
CyberScan PC 6000	pH/ORP/Conductivity/ TDS/Salinity/Resistivity/ °C/°F	.. to 500 ppt	0.5 % full scale + LSD	5	Yes	1000 per parameter	Yes	–	Internet/intranet, RS232C, USB, IrDA, SD card	<b>Pg 80</b>
PC 2700	pH/ORP/Ion/ Conductivity/TDS/ Salinity/Resistivity/°C/°F	0.050 mg/L to 500.0 g/L	±1 % full scale	5	Yes	500	Yes	–	RS232	<b>Pg 81</b>
PC 700	pH/ORP/Conductivity/ TDS/Resistivity/°C/°F	.. to 100.0 ppt @ 0.5 fact (200.0 @ 1 factor)	±1 % full scale	5	–	100	Yes	–	–	<b>Pg 82</b>
CyberScan CON 6000	Conductivity/TDS/ Salinity/Resistivity/°C/°F	.. to 500 ppt	0.5 % full scale + LSD	5	Yes	1000 per parameter	Yes	–	Internet/intranet, RS232C, USB, IrDA, SD card	<b>Pg 50</b>
CON 2700	Conductivity/TDS/ Salinity/Resistivity/°C/°F	0.050 mg/L to 500.0 g/L	±1 % full scale	5	–	100	Yes	–	RS232C	<b>Pg 51</b>
CON 700	Conductivity/TDS/°C/°F	.. to 100.0 ppt @ 0.5 fact (200.0 @ 1 factor)	±1 % full scale	5	–	50	Yes	–	–	<b>Pg 52</b>

\* Maximum 199.9 ppt depending on factor setting \*\* Maximum 500 ppt depending on factor setting

## Salinity Meter Quick Guide



Models	Parameters	Salinity Range	Accuracy	Cal. Points	GLP	Memory	Temperature Display	Housing Rating	Communication	Page No.
<b>Pocket Testers</b>										
<b>PCSTestr 35</b>	pH/Conductivity/TDS/Salinity/°C/°F	0.0 to 99.9 ppm 100 to 999 ppm 1.00 to 10.00 ppt 0.0 to 1.00 ‰	±1 % full scale *	1 (manual above 1.00 ppt)	–	–	Yes	IP67	–	<b>Pg 70</b>
<b>SaltTestr 11</b>	Salinity/°C/°F	.. to 10.00 ppt	±1 % full scale	1 (manual)	–	–	Yes	IP67	–	<b>Pg 39</b>
<b>EcoTestr Salt</b>	Salinity	.. to 10.00 ppt	±1 % full scale (±2 % above 5 ppt)	1	–	–	–	IP67	–	<b>Pg 40</b>
<b>Handheld Meters</b>										
<b>CyberScan PCD 650</b>	pH/ORP/Ion/Conductivity/TDS/Salinity/Resistivity/Dissolved Oxygen/°C/°F	.. to 0.770 ppm 0.770 to 143.3 ppm 143.3 ppm to 2.138 ppt 2.183 to 23.64 ppt 23.64 to 80.00 ppt	±1 % full scale + 1 LSD	5	Yes	500	Yes	IP67	LED RS232C, IrDA	<b>Pg 72</b>
<b>CyberScan PC 650</b>	pH/ORP/Ion/Conductivity/TDS/Salinity/Resistivity/°C/°F	.. to 0.770 ppm 0.770 to 143.3 ppm 143.3 ppm to 2.138 ppt 2.183 to 23.64 ppt 23.64 to 80.00 ppt	±1 % full scale + 1 LSD	5	Yes	500	Yes	IP67	LED RS232C, IrDA	<b>Pg 73</b>
<b>CyberScan CD 650</b>	Conductivity/TDS/Salinity/Resistivity/Dissolved Oxygen/°C/°F	.. to 0.770 ppm 0.770 to 143.3 ppm 143.3 ppm to 2.138 ppt 2.183 to 23.64 ppt 23.64 to 80.00 ppt	±1 % full scale + 1 LSD	5	Yes	500	Yes	IP67	LED RS232C, IrDA	<b>Pg 73</b>
<b>CyberScan COND 610</b>	Conductivity/TDS/Salinity/Resistivity/°C/°F	.. to 0.770 ppm 0.770 to 143.3 ppm 143.3 ppm to 2.138 ppt 2.183 to 23.64 ppt 23.64 to 80.00 ppt	±1 % full scale + 1 LSD	5	Yes	500	Yes	IP67	LED RS232C, IrDA	<b>Pg 43</b>
<b>Salt 6+</b>	Salinity/°C	1.0 to 50.00 ppt 0.1 to 5.00 ‰	±1 % full scale	1 (manual)	–	–	Yes	IP67	–	<b>Pg 47</b>
<b>Bench Meters</b>										
<b>CyberScan PCD 6500</b>	pH/ORP/Ion/Conductivity/TDS/Salinity/Resistivity/Dissolved Oxygen/°C/°F	.. to 0.094 ppt 0.094 to 1.000 ppt 1.0 to 11.50 ppt 11.50 to 90.00 ppt	0.5 % full scale + LSD	5	Yes	1000 per parameter	Yes	–	Internet/I intranet, RS232C, USB, IrDA, SD card	<b>Pg 79</b>
<b>CyberScan PC 6500</b>	pH/ORP/Ion/Conductivity/TDS/Salinity/Resistivity/°C/°F	.. to 0.094 ppt 0.094 to 1.000 ppt 1.0 to 11.50 ppt 11.50 to 90.00 ppt	0.5 % full scale + LSD	5	Yes	1000 per parameter	Yes	–	Internet/I intranet, RS232C, USB, IrDA, SD card	<b>Pg 80</b>
<b>CyberScan PC 6000</b>	pH/ORP/Conductivity/TDS/Salinity/Resistivity/°C/°F	.. to 0.094 ppt 0.094 to 1.000 ppt 1.0 to 11.50 ppt 11.50 to 90.00 ppt	0.5 % full scale + LSD	5	Yes	1000 per parameter	Yes	–	Internet/I intranet, RS232C, USB, IrDA, SD card	<b>Pg 80</b>
<b>PC 2700</b>	pH/ORP/Ion/Conductivity/TDS/Salinity/Resistivity/°C/°F	0.0 to 80.0 ppt	±1 % full scale	5	Yes	500	Yes	–	RS232	<b>Pg 81</b>
<b>CyberScan CON 6000</b>	Conductivity/TDS/Salinity/Resistivity/°C/°F	.. to 0.094 ppt 0.094 to 1.000 ppt 1.0 to 11.50 ppt 11.50 to 90.00 ppt	0.5 % full scale + LSD	5	Yes	1000 per parameter	Yes	–	Internet/I intranet, RS232C, USB, IrDA, SD card	<b>Pg 50</b>
<b>CON 2700</b>	Conductivity/TDS/Salinity/Resistivity/°C/°F	0 to 80.0 ppt	±1 % full scale	5	Yes	500	Yes	–	RS232	<b>Pg 51</b>

\* Applicable from 100 ppm to 10.00 ppt / 0.0 to 1.00 ‰



**Meter Selection Guide**  
DO Meter Quick Guide

Dissolved Oxygen Meter Quick Guide



Models	Parameters	DO Range	Accuracy	Cal. Points	GLP	Memory	Barometric / Salinity Compensation	Housing Rating	Communication	Page No.
<b>Handheld Meters</b>										
<b>CyberScan PCD 650</b>	pH/ORP/Ion/ Conductivity/TDS/ Salinity/Resistivity/ Dissolved Oxygen/°C/°F	0 to 600 %, 0.00 to 90.00 mg/L or ppm	±2.0 %, ±0.2 mg/L	1 (mg/L)	Yes	500	Yes	IP67	LED RS232C, IrDA	<b>Pg 72</b>
<b>CyberScan PD 650</b>	pH/ORP/Ion/Dissolved Oxygen/°C/°F	0 to 600 %, 0.00 to 90.00 mg/L or ppm	±2.0 %, ±0.2 mg/L	1 (mg/L)	Yes	500	Yes	IP67	LED RS232C, IrDA	<b>Pg 73</b>
<b>CyberScan CD 650</b>	Conductivity/TDS/ Salinity/Resistivity/ Dissolved Oxygen/°C/°F	0 to 600 %, 0.00 to 90.00 mg/L or ppm	±2.0 %, ±0.2 mg/L	1 (mg/L)	Yes	500	Yes	IP67	LED RS232C, IrDA	<b>Pg 73</b>
<b>CyberScan DO 600</b>	Dissolved Oxygen/°C/°F	0 to 600 %, 0 to 90 mg/L or ppm	±2.0 %, ±0.2 mg/L	2 (0 %, 100 %) 1 (mg/L)	Yes	500	Yes	IP67	LED RS232C, IrDA	<b>Pg 58</b>
<b>CyberScan DO 300</b>	Dissolved Oxygen/°C/°F	0 to 199.9 %, 0 to 19.99 mg/L	±1.5 % full scale	2 (0 %, 100 %) 1 (mg/L)	Yes	50	Yes	IP67	–	<b>Pg 59</b>
<b>CyberScan DO 110</b>	Dissolved Oxygen/°C/°F	0 to 199.9 %, 0 to 19.99 mg/L	±1.5 % full scale	2 (0 %, 100 %) 1 (mg/L)	–	100	Yes	IP54	RS232C	<b>Pg 60</b>
<b>DO 6+</b>	Dissolved Oxygen/°C	0 to 199.9 %, 0 to 19.99 mg/L	±1.5 % full scale	2 (0 %, 100 %) 1 (mg/L)	–	–	Yes	IP54	–	<b>Pg 61</b>
<b>Bench Meters</b>										
<b>CyberScan PCD 6500</b>	pH/ORP/Ion/ Conductivity/TDS/ Salinity/Resistivity/ Dissolved Oxygen/ BOD/OUR/SOUR/°C/°F	0 to 600 %, 0 to 60 mg/L 0 to 1272 mbar	0.1 % 0.1 +1 LSD 0.1 mbar	2 (0 %, 100 %) 2 (0 mg/L, 8.26 mg/L)	Yes	1000 per parameter	Yes	–	Internet/intranet, RS232C, USB, IrDA, SD card	<b>Pg 79</b>
<b>CyberScan DO 6000</b>	Dissolved Oxygen/BOD/ OUR/SOUR/°C/°F	0 to 600 %, 0 to 60 mg/L 0 to 1272 mbar	0.1 % 0.1 +1 LSD 0.1 mbar	2 (0 %, 100 %) 2 (0 mg/L, 8.26 mg/L)	Yes	1000 per parameter	Yes	–	Internet/intranet, RS232C, USB, IrDA, SD card	<b>Pg 64</b>
<b>DO 2700</b>	Dissolved Oxygen/ BOD/°C/°F	0 to 600 %, 0 to 50.0 mg/L	±0.5 % full scale	2	Yes	500	Yes	–	RS232C	<b>Pg 65</b>
<b>DO 700</b>	Dissolved Oxygen/°C/°F	0 to 199.9 %; 300 %, 0 to 30 mg/L	±0.5 % full scale	2	–	100	Yes	–	–	<b>Pg 66</b>

Multi-Parameter Meter Quick Guide



Models	Parameters	Range	Accuracy	Cal. Points	GLP	Memory	Temperature Display	Housing Rating	Communication	Page No.					
<b>Pocket Testers</b>															
<b>PCSTestr 35</b>	pH	0.00 to 14.00 pH	±0.01 pH	5 auto	-	-	Yes	IP67	-	<b>Pg 70</b>					
	Conductivity	.. to 200.0 µS ; 200 to 2000 µS ; 2.00 to 20.00 mS	± 1 % full scale	3 auto 3 manual											
	TDS	0.0 to 99.9 ppm ; 100 to 999 ppm ; 1.00 to 10.00 ppt	± 1 % full scale	3 manual											
	Salinity	0.0 to 99.9 ppm ; 100 to 999 ppm ; 1.00 to 10.00 ppt ; 0.0 to 1.00 %	± 1 % full scale *	1 (manual above 1.00 ppt)											
	Temperature	0 to 50.0 °C ; 32 to 122 °F	0.5 °C ; 0.9 °F	-											
<b>PCTestr 35</b>	pH	0.0 to 14.0 pH	±0.01 pH	5 auto	-	-	Yes	IP67	-	<b>Pg 70</b>					
	Conductivity	.. to 2000 µS ; 2.00 to 20.00 mS	± 1 % full scale	2 auto 2 manual											
	Temperature	0 to 50.0 °C ; 32 to 122 °F	0.5 °C ; 0.9 °F	-											
<b>PTTestr 35</b>	pH	0.0 to 14.0 pH	±0.01 pH	5 auto	-	-	Yes	IP67	-	<b>Pg 70</b>					
	TDS	0 to 999 ppm ; 1.00 to 10.00 ppt	± 1 % full scale	2 manual											
<b>Handheld Meters</b>															
<b>CyberScan PCD 650</b>	pH	-2.000 to 20.000 pH	±0.002 pH	6	-	-	-	-	-	<b>Pg 72</b>					
	ORP	±2000.0 mV	±0.2 mV	-											
	Ion	0.001 to 19900	0.5 % full scale (monovalent) 1 % full scale (divalent)	8											
	Conductivity	.. to 2.000 µS ; 2.000 to 300.0 µS ; 300.0 µS to 4.000 mS ; 4.000 to 40.00 mS ; 40.00 to 500.0 mS	±1 % full scale + 1 LSD	4 auto 5 manual											
	TDS	.. to 2.000 ppm ; 2.000 to 300.0 ppm ; 300.0 ppm to 4.000 ppt ; 4.000 to 40.00 ppt ; 40.00 to 500.0 ppt	±1 % full scale + 1 LSD	5							Yes	500	Yes	IP67	LED RS232C, IrDA
	Salinity	.. to 0.770 ppm ; 0.770 to 143.3 ppm ; 143.3 ppm to 2.138 ppt ; 2.183 to 23.64 ppt ; 23.64 to 80.00 ppt	±1 % full scale + 1 LSD	5											
	Resistivity	2.00 to 25.00 Ω ; 25.00 to 250.0 Ω ; 250.0 Ω to 3.333 kΩ ; 3.333 to 500.0 kΩ ; 500.0 kΩ to 20.00 MΩ	±1 % full scale	5											
	Dissolved Oxygen	0.00 to 90.00 mg/L or ppm ; 0 to 600.0 %	±0.2 mg/L ±2.0 %	1											
Temperature	-10.0 to 110.0 °C ; 14.0 to 230.0 °F	±0.5 °C ; ±0.9 °F	-												
<b>CyberScan PC 650</b>	pH	-2.000 to 20.000 pH	±0.002 pH	6	-	-	-	-	-	<b>Pg 73</b>					
	ORP	±2000.0 mV	±0.2 mV	-											
	Ion	0.001 to 19900	0.5 % full scale (monovalent) 1 % full scale (divalent)	8											
	Conductivity	.. to 2.000 µS ; 2.000 to 300.0 µS ; 300.0 µS to 4.000 mS ; 4.000 to 40.00 mS ; 40.00 to 500.0 mS	±1 % full scale + 1 LSD	4 auto 5 manual											
	TDS	.. to 2.000 ppm ; 2.000 to 300.0 ppm ; 300.0 ppm to 4.000 ppt ; 4.000 to 40.00 ppt ; 40.00 to 500.0 ppt	±1 % full scale + 1 LSD	5							Yes	500	Yes	IP67	LED RS232C, IrDA
	Salinity	.. to 0.770 ppm ; 0.770 to 143.3 ppm ; 143.3 ppm to 2.138 ppt ; 2.183 to 23.64 ppt ; 23.64 to 80.00 ppt	±1 % full scale + 1 LSD	5											
	Resistivity	2.00 to 25.00 Ω ; 25.00 to 250.0 Ω ; 250.0 Ω to 3.333 kΩ ; 3.333 to 500.0 kΩ ; 500.0 kΩ to 20.00 MΩ	±1 % full scale	5											
	Temperature	-10.0 to 110.0 °C ; 14.0 to 230.0 °F	±0.5 °C ; ±0.9 °F	-											

\* Applicable from 100 ppm to 10.00 ppt / 0.0 to 1.00 %

[Continued on page 10]

## Meter Selection Guide

### Multi-Parameter Meter Quick Guide



## Multi-Parameter Meter Quick Guide

[Continued from page 09]

Models	Parameters	Range	Accuracy	Cal. Points	GLP	Memory	Temperature Display	Housing Rating	Communication	Page No.
<b>Handheld Meters</b>										
<b>CyberScan PD 650</b>	pH	-2.000 to 20.000 pH	±0.002 pH	6	Yes	500	Yes	IP67	LED RS232C, IrDA	<b>Pg 73</b>
	ORP	±2000.0 mV	±0.2 mV	–						
	Ion	0.001 to 19900	0.5 % full scale (monovalent) 1 % full scale (divalent)	8						
	Dissolved Oxygen	0.00 to 90.00 mg/L or ppm 0 to 600.0 %	±0.2 mg/L ±2.0 %	1						
	Temperature	-10.0 to 110.0 °C; 14.0 to 230.0 °F	±0.5 °C; ±0.9 °F	–						
<b>CyberScan CD 650</b>	Conductivity	.. to 2.000 µS 2.000 to 300.0 µS 300.0 µS to 4.000 mS 4.000 to 40.00 mS 40.00 to 500.0 mS	±1 % full scale + 1 LSD	4 auto 5 manual	Yes	500	Yes	IP67	LED RS232C, IrDA	<b>Pg 73</b>
	TDS	.. to 2.000 ppm 2.000 to 300.0 ppm 300.0 ppm to 4.000 ppt 4.000 to 40.00 ppt 40.00 to 500.0 ppt	±1 % full scale + 1 LSD	5						
	Salinity	.. to 0.770 ppm 0.770 to 143.3 ppm 143.3 ppm to 2.138 ppt 2.183 to 23.64 ppt 23.64 to 80.00 ppt	±1 % full scale + 1 LSD	5						
	Resistivity	2.00 to 25.00 Ω 25.00 to 250.0 Ω 250.0 Ω to 3.333 kΩ 3.333 to 500.0 kΩ 500.0 kΩ to 20.00 MΩ	±1 % full scale	5						
	Dissolved Oxygen	0.00 to 90.00 mg/L or ppm 0 to 600.0 %	±0.2 mg/L ±2.0 %	1						
	Temperature	-10.0 to 110.0 °C; 14.0 to 230.0 °F	±0.5 °C; ±0.9 °F	–						
<b>Bench Meters</b>										
<b>CyberScan PCD 6500</b>	pH	-2.000 to 20.000 pH	±0.002 pH	5	Yes	1000 per parameter	Yes	–	Internet, intranet, RS232C, USB, IrDA, SD card	<b>Pg 79</b>
	ORP	±2000.0 mV	±0.2 mV	–						
	Ion	1 x 10 <sup>-7</sup> to 9.99 x 10 <sup>10</sup> ppm	±0.17 n %	5						
	Conductivity	.. to 200 µS 200.0 µS to 2.000 mS 2.000 to 20.00 mS 20.00 to 500.0 mS	0.5 % full scale + LSD	5						
	TDS	.. to 200 ppm 200.0 to 2000 ppm 2.000 to 20.00 ppt 20.00 to 500.0 ppt	0.5 % full scale + LSD	5						
	Salinity	.. to 0.094 ppt 0.094 to 1.000 ppt 1.0 to 11.50 ppt 11.50 to 90.00 ppt	0.5 % full scale + LSD	5						
	Resistivity	0 to 20.00 kΩ 20.00 to 200.0 kΩ 200.0 kΩ to 2.000 MΩ 2.000 to 100.0 MΩ	0.5 % full scale + LSD	5						
	Dissolved Oxygen	0 to 600 % 0 to 60 mg/L 0 to 1272 mbar	0.1 % 0.1 + 1 LSD 0.1 mbar	2(0 %, 100 %) 2(0 mg/L, 8.26 mg/L)						
	Temperature	-5.0 to 105.0 °C	±0.2 °C	–						

[Continued on page 11]





## Multi-Parameter Meter Quick Guide

[Continued from page 10]

Models	Parameters	Range	Accuracy	Cal. Points	GLP	Memory	Temperature Display	Housing Rating	Communication	Page No.
<b>Bench Meters</b>										
<b>CyberScan PC 6500</b>	pH	-2.000 to 20.000 pH	±0.002 pH	5	Yes	1000 per parameter	Yes	-	Internet, intranet, RS232C, USB, IrDA, SD card	<b>Pg 80</b>
	ORP	±2000.0 mV	±0.2 mV	1						
	Ion	1 x 10 <sup>-7</sup> to 9.99 x 10 <sup>10</sup> ppm	±0.17 n %	5						
	Conductivity	.. to 200 µS 200.0 µS to 2.000 mS 2.000 to 20.00 mS 20.00 to 500.0 mS	0.5 % full scale + LSD	5						
	TDS	.. to 200 ppm 200.0 to 2000 ppm 2.000 to 20.00 ppt 20.00 to 500.0 ppt	0.5 % full scale + LSD	5						
	Salinity	.. to 0.094 ppt 0.094 to 1.000 ppt 1.0 to 11.50 ppt 11.50 to 90.00 ppt	0.5 % full scale + LSD	5						
	Resistivity	0 to 20.00 kΩ 20.00 to 200.0 kΩ 200.0 kΩ to 2.000 MΩ 2.000 to 100.0 MΩ	0.5 % full scale + LSD	5						
Temperature	-5.0 to 105.0 °C	±0.2 °C	1							
<b>CyberScan PC 6000</b>	pH	-2.000 to 20.000 pH	±0.002 pH	5	Yes	1000 per parameter	Yes	-	Internet, intranet, RS232C, USB, IrDA, SD card	<b>Pg 80</b>
	ORP	±2000.0 mV	±0.2 mV	1						
	Conductivity	.. to 200 µS 200.0 µS to 2.000 mS 2.000 to 20.00 mS 20.00 to 500.0 mS	0.5 % full scale + LSD	5						
	TDS	.. to 200 ppm 200.0 to 2000 ppm 2.000 to 20.00 ppt 20.00 to 500.0 ppt	0.5 % full scale + LSD	5						
	Salinity	.. to 0.094 ppt 0.094 to 1.000 ppt 1.0 to 11.50 ppt 11.50 to 90.00 ppt	0.5 % full scale + LSD	5						
	Resistivity	0 to 20.00 kΩ 20.00 to 200.0 kΩ 200.0 kΩ to 2.000 MΩ 2.000 to 100.0 MΩ	0.5 % full scale + LSD	5						
	Temperature	-5.0 to 105.0 °C	±0.2 °C	1						
<b>PC 2700</b>	pH	-2.000 to 20.000 pH	±0.002 pH	6	Yes	500	Yes	-	RS232	<b>Pg 81</b>
	ORP	±2000.0 mV	0.1 mV	1						
	Ion	0.001 to 19999	0.5 % full scale (monovalent) 1 % full scale (divalent)	8						
	Conductivity	0.050 µS to 500.0 mS	±1 % full scale	5						
	TDS	0.050 mg/L to 500.0 g/L	±1 % full scale	5						
	Salinity	0.0 to 80.0 ppt	±1 % full scale	5						
	Resistivity	2.000 Ω to 20.0 MΩ	±1 % full scale	5						
Temperature	0.0 to 100.0 °C ; 32.0 to 212.0 °F	±0.3 °C ; ±0.5 °F	1							
<b>PC 700</b>	pH	0.00 to 14.00 pH	±0.01 pH + 1 LSD	5	-	100	Yes	-	-	<b>Pg 82</b>
	ORP	±2000 mV	±0.2 mV (±199.9 mV) ±2 mV (beyond)	1						
	Conductivity	0.0 µS to 200.0 mS	±1 % full scale	5						
	TDS	.. to 100.0 ppt @ 0.5 fact (200.0 @ 1 factor)	±1 % full scale	5						
	Temperature	0.0 to 100.0 °C ; 32.0 to 212.0 °F	±0.5 °C ; ±0.9 °F	1						

**Meter Selection Guide**  
Colorimeter Quick Guide

Colorimeter Quick Guide



Parameters	Range	Resolution	Accuracy	C401	C301	C201	C105	C103	Page No.
Chlorine, Free and Total	0 - 1.99 ppm	0.01 ppm	±0.02 ppm	✓	✓	✓	-	-	Pg 89
	2.0 - 6.0 ppm	0.1 ppm	±0.2 ppm						
Cyanuric Acid	5 - 90 ppm	1 ppm	±4 ppm	✓	-	-	-	-	
pH	5.9 - 8.2 pH	0.1 pH	±0.1 pH	✓	✓	-	-	-	
Chlorine Dioxide	0 - 3.79 ppm	0.01 ppm	±0.02 ppm	-	-	-	-	✓	
	3.8 - 11.4 ppm	0.1 ppm	±0.2 ppm						
Ozone	0 - 1.39 ppm	0.01 ppm	±0.02 ppm	-	-	-	✓	-	
	1.4 - 4.1 ppm	0.1 ppm	±0.2 ppm						

Look for these features in Eutech meters

	Automatic Temperature Compensation automatically corrects the measured value based on the temperature of the solution with the use of a built-in temperature sensor
	CE-certified products
	Manual Temperature Compensation is an alternative method for temperature compensation through the manual input of sample temperature value
	IP67-rated housing offers complete protection against dust and allows immersion in water between 15 cm to 1 m
	Automatic Calibration frees users from cumbersome fine adjustment or manual selection of desired standards in Conductivity and Dissolved Oxygen calibration routine
	IP54-rated housing protects instrument from dust and water spray from all directions
	Auto-Buffer Recognition identifies and ensures correct pH buffer values are being used during calibration
	Pocket testers, colorimeters and turbidity meters are covered by Eutech warranty for 2 years
	Good Laboratory Practices (GLP) refers to regulations that are observed to ensure high quality experimental standards and reliable data
	Handheld meters and bench meters are covered by an extended warranty for 3 years
	RS232C cable output for serial communication between meters and PC or other peripheral devices
	All Eutech electrodes have 6 months warranty
	Infrared communications technology for wireless data transfer from meter to PC or other peripheral devices
	Automatic Pressure Compensation automatically corrects dissolved oxygen measurements for pressure changes from built-in barometric pressure sensor for most accurate measurements
	USB connectivity for output to PC or other peripheral devices



pH/ORP

The measure of acidity or alkalinity of a liquid.

**Tester:**

- 1. pHTestr® 30
- 2. pHTestr® 20
- 3. pHTestr® 10
- 4. EcoTestr pH 2
- 5. pHTestr® 10BNC
- 6. pH Spear
- 7. ORPTestr® 10
- 8. ORPTestr® 10BNC

**Handheld:**

- 1. CyberScan pH 620
- 2. CyberScan pH 610
- 3. CyberScan pH 600
- 4. CyberScan pH 310
- 5. CyberScan pH 300
- 6. CyberScan pH 110
- 7. CyberScan pH 11
- 8. Ion 6+
- 9. pH 6+
- 10. pH 5+

**Bench:**

- 1. CyberScan pH 6500
- 2. CyberScan pH 6000
- 3. Ion 2700
- 4. pH 2700
- 5. Ion 700
- 6. pH 700



# About pH/ORP Measurement

## About pH Measurement

### Why is pH Important?

pH is one of the most common parameters measured in a wide variety of industries such as water and wastewater treatment, agriculture research and production, environmental monitoring, chemical and life sciences research, electronics production as well as other industrial applications.

Here are examples of pH in a few common industrial and household products:

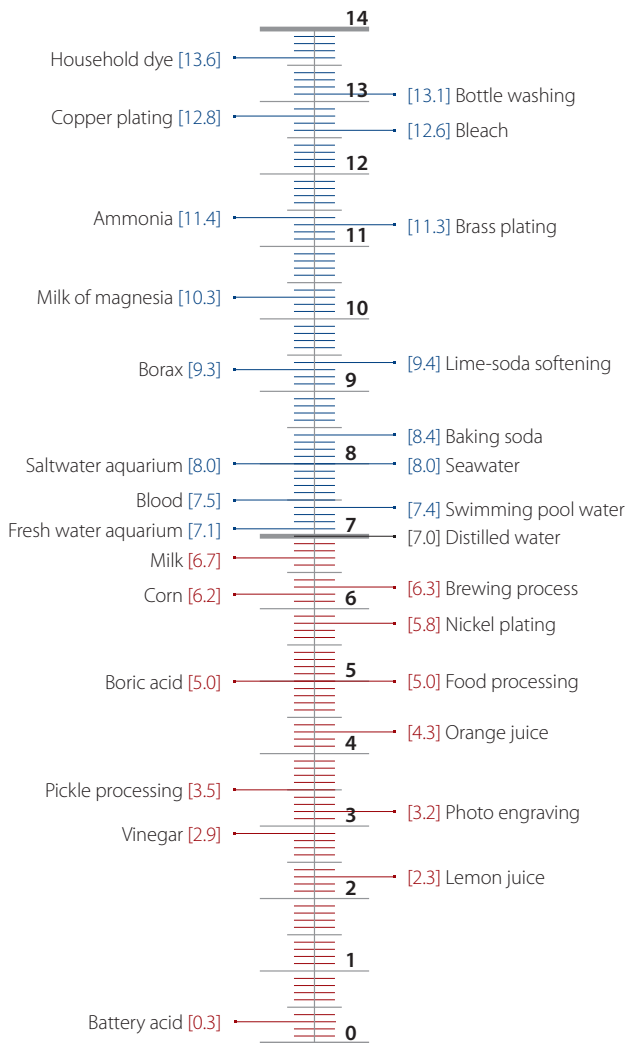

### pH Measurement

pH is always measured across a medium.

Although the litmus paper is one of the most common methods of pH measurement, it can only provide a rough indication which might be insufficient in most applications.

The more accurate method involves the use of a measurement system that consists of a pH meter and a pH electrode that has a hydrogen ion sensitive glass bulb. The most common sensing element used in the electrode is the glass membrane as it is selective for H<sup>+</sup> ions i.e. H<sup>+</sup> ions can permeate through the hydrated layer of glass membrane. However the electrode body may not necessarily be glass.

The movement of ions into the hydrated membrane changes the electrochemical effect inside the glass which is measured in mV and then converted via the pH meter to be reflected as a pH value.

Therefore depending on the concentration of ions in the solution, the mV and hence pH varies.

The performance of an electrode is dependent on two parameters – Offset and Slope.

### Offset in pH Electrode

Theoretically, when placed in pH 7.00 buffer at 25 °C, a pH electrode produces 0 mV which the pH meter reads as 7.00 pH. The difference between 0 mV and the electrode's actual reading is called the offset error which can be as high as ±25 mV.

In other words, when the electrode is not in measurement or in pH 7 buffer solution, the output (or reading) will be known as the offset.

While in theory, the mV value should be zero, however in practice this is rarely the case because of the following reasons:

- Liquid difference
- Bulb composition
- Wire geometry difference and other factors

**In practice, it is unrealistic to achieve zero offset in electrodes. The Eutech range of advanced micro-processor based meters provides offset calibration abilities for consistent and reliable measurements.**

### Slope in pH Electrode

A pH electrode produces different mV in different solutions. Therefore, the slope of the electrode can be defined as

**Slope = mV/pH unit**

A perfect pH electrode, at 25 °C, produces a slope of 59.16 mV per pH unit. For example, an electrode with 0 mV offset should read mV value of 177.48 mV when placed in a pH 4.01 solution. The slope is hence calculated as (177.48 mV - 0 mV) / 3 pH = 59.16 mV/pH. The difference between this perfect slope reading and the electrode's actual reading is called the slope error.

These theoretical values are not always achieved, even with brand new electrodes. The slope of a new pH electrode should fall between 92 % and 102 % of 59.16 mV. If the slope falls below 92 %, cleaning of the electrode may be needed.

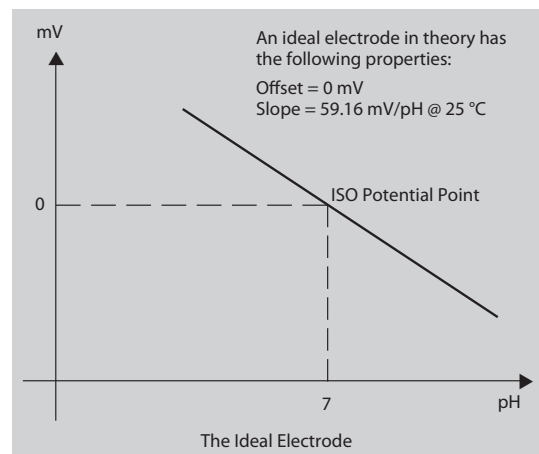

## Temperature Compensation

In a perfect pH electrode – one that measures zero at exactly pH 7 – there is no temperature effect on the electrode sensitivity at pH 7 regardless of temperature change. Most pH electrodes are not perfect, but the errors from changes in temperature are still very minute when near pH 7, plus or minus one-tenths of a pH, and can be disregarded. However, the further from pH 7 the solution is and the greater the temperature changes, the greater the expected measurement error due to changes in the electrode's sensitivity. For most electrodes, the error is approximately 0.003 pH/°C/pH away from pH 7.

For example, if a pH meter is calibrated at room temperature (25 °C) and is measuring a sample around pH 4 at around 5 °C,

Temperature difference: 25 °C - 5 °C = 20 °C  
pH away from neutral: 7 pH - 4 pH = 3 pH  
Total error: 0.003 x 20 x 3 = 0.18 pH

To overcome this error, pH meters require some form of temperature compensation to ensure standardized pH values. Meters and controllers with Automatic Temperature Compensation (ATC) receive a continuous signal from a temperature sensing element and automatically correct the pH value based on the temperature of the solution. Manual Temperature Compensation requires the user to enter the temperature of the solution in order to correct pH readings for temperature. ATC is considered to be more practical for most pH applications.

**Most Eutech meters offer ATC capabilities. Models with this feature include the pHTestr® 10, 20, 30 and all the handheld and bench pH meters.**

## Single and Double Junction Electrodes

For many applications, a single junction reference electrode is satisfactory. However, if samples contain proteins, sulfides, heavy metals or any other material which interacts with silver ions, unwanted side reactions may occur. These reactions can lead to erroneous reference signals or to precipitation at the reference junction leading to a short service life.

A double junction reference design affords a barrier of protection to combat the above interactions. When in doubt about using single or double junction designs, the safest approach is to use the double junction as they can be used anywhere a single junction design can be used. Conversely, single junction designs should not be used where double junction designs are needed. In most process applications, it is recommended to use double junction electrodes.

**Eutech's new range of large screen pocket testers pHTestr® series feature double junction electrodes that extend useful life and provide long term cost savings for users.**

## Normal Aging

As electrodes are used or stored for long periods they will experience some deterioration in performance. Offsets will change and slope errors will increase. By using the calibration controls these errors can be corrected. If an electrode is able to be calibrated and is stable and responsive, it is still a functional electrode and may be used in service even though it no longer meets "new" electrode specifications.

## About ORP Measurement

### ORP – Oxidation Reduction Potential

Oxidation-Reduction Potential (ORP) or Redox Potential measurements are used to monitor chemical reactions, to quantify ion activity, or to determine the oxidizing or reducing properties of a solution. ORP is a measurement of the electrical potential of a redox reaction and serves as a yardstick to judge how much oxidation or reduction takes place under existing conditions.

ORP electrodes measure the voltage across a circuit formed by the measuring metal half cell and the reference half cell. When the ORP electrode is placed in the presence of oxidizing or reducing agents, electrons are constantly transferred back and forth on its measuring surface, generating a tiny voltage. The ORP measurement can be made using the millivolt mode of a pH meter.

Major areas of usage include the treatment of industrial wastes, study of biological systems, oxidation of cyanide, bleaching of pulp, manufacture of bleach and reduction of chromate wastes.

The measurement of ORP is also useful in pool water treatment as an indication of sanitation in relation to free chlorine parameter. ORP technology has gained recognition worldwide and is found to be a reliable indicator of bacteriological water quality. The table below illustrates the Kill Time of E.Coli bacteria as a function of ORP value. With a value of 600 mV, the life of the bacteria is almost 2 minutes; at 650 mV it reduces to 30 seconds. Above 700 mV the bacteria is killed within a few seconds. It is therefore necessary for the water to have an ORP value of at least 700 mV to ensure good water quality.

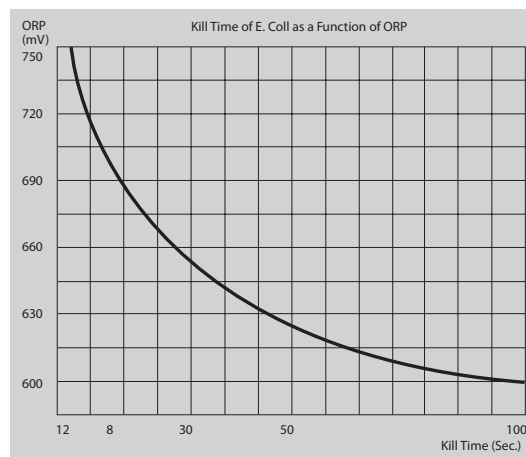

ORP value also depends on the pH of pool water. Normal values lie between 7.2 and 7.6 pH with a tendency to increase to around 8.0 to 9.0 pH depending on the level of contamination. The pH of the pool water has to be maintained at the optimum level between 7.2 and 7.6 pH by dosing appropriate chemicals. If the pH of the swimming pool water is acceptable and the ORP value is below 700 mV, hypochlorite or other oxidising chemicals should be added.

**Eutech offers a wide range of meters that measure both pH and ORP values in various educational, laboratory and industrial applications. These include ORPTestr® 10 pocket tester, handheld meters CyberScan Series pH 300, pH 310, pH 11 and pH 110, pH 6+ and the CyberScan bench meter series 510, 1100, 2100, 1500 and the colour touchscreen research-grade series 6000.**

**pH/ORP**  
Pocket Tester

pH / ORP



Large custom dual-display LCD



Ribbed body for better grip



User-replaceable sensor



Comes with protective plastic case and lanyard

**pHTestr® 30 ; pHTestr® 20 ; pHTestr® 10**

pH/°C/°F

pH

pH

pH measurement has never been easier with the pHTestr® series. Accurate, handy and user-friendly, the pHTestr 30, pHTestr 20 and pHTestr 10 are best pocket testers in their class.



Battery-life indicator

Waterproof to IP67 standards

Temperature display in °C or °F

Valox® strong plastic casing offers superior chemical resistance

Easy twist-off user-replaceable sensor

Polymer gel reference increases sensor life

Chemical resistant Kynar® double-junction sensor for longer sensor lifespan

**Applications**

**General:** Quick and accurate checks in pools and spas, aquariums and hydroponics operations, or wherever frequent pH testing is required.

**Industrial:** Cooling towers, food processing, water and wastewater treatment, photo-development, printing and chemical industries.

**Educational:** Useful for most laboratory, ecological studies and other applications.

**High Accuracy**

- Up to ±0.01 pH accuracy at 0.01 pH resolution
- 3-point push-button calibration with USA and NIST buffer option sets – quick, easy calibration with no mistakes
- Automatic Temperature Compensation (ATC) for accurate readings even in varying conditions

**Long Lasting**

- Double-junction sensor with chemical resistant Kynar® porous junction minimizes clogging and contamination
- Longer electrode lifespan with increased polymer gel volume
- Rugged and waterproof to IP67 standards. So light, it floats!

**User-Friendly**

- Large custom dual display LCD
- Calibration settings remain, even when tester runs out of batteries





## EcoTestr pH 2

pH

Economical pH measurement is a breeze with the EcoTestr pH 2. Designed for fuss-free measurements on the go, the pH 2 is ideal for quick pH measurements in hydroponic gardening, aquaculture, agriculture, pools, simple lab work and other water/wastewater applications.



Automatic pH calibration feature – switch tester to calibration mode, immerse sensor in pH buffer solution and leave tester to do the rest

Automatic temperature compensation adjust readings according to temperature change automatically for greater accuracy



Pocket clip secures tester firmly to your belt or pocket



Durable keypad



IP67 waterproof – lightweight tester floats on water for easy retrieval



Transparent protective cap doubles up as a container for sensor conditioning or on-site calibration

- $\pm 1$  % accuracy
- Quick, easy calibrations at the press of a button with auto-buffer recognition and auto-calibration functions
- Up to three calibration points for broadened accuracy throughout the pH range



### Applications

Water and wastewater treatment  
 • Environmental monitoring • Education  
 • Hydroponics • Agriculture • Aquaculture and aquariums • Pools and spas • Food and beverage manufacturing • Cooling towers  
 • Electroplating • Printing • Photo-development and more!

## pHTestr® 10BNC

pH/°C/°F

The versatile pHTestr 10BNC comes with a BNC electrode connection, allowing the tester to be used with a wide range of specialty electrodes with various cable lengths – especially useful in inaccessible areas such as cooling towers or large drums used in yoghurt production.

### Applications

**General:** Quick and accurate checks in pools and spas, aquariums and hydroponics operations, or wherever frequent pH testing is required.

**Industrial:** Cooling towers, food processing, water and wastewater treatment, photo-development, printing and chemical industries.

**Educational:** Useful for most laboratory, ecological studies and other applications.

- User-selectable electrodes with BNC connectors
- Up to ±0.01 pH accuracy at 0.01 pH resolution
- Non-volatile memory holds your tester settings, even when batteries run out
- 3-point push-button calibration with USA and NIST buffer option sets – quick, easy calibrations with no mistake
- Advance power management – 500 hours of operation on one set of batteries
- Large custom dual-display LCD
- Waterproof to IP67 standard. So light, it floats!



Light-weight tester floats for easy retrieval

BNC connector enables testing with a wide range of specialty electrodes with BNC connectors



Meat



Cheese

## pH Spear

pH/°C/°F

Specially designed for food applications, the Eutech pH Spear is equipped with a tough spear tip open pore sensor, and allows direct pH measurement of solid or semi-solid samples like cheese, fruits, meat and wet soil.

### Applications

- Bread • Meat • Cheese • Salami • Ice-cream
- Poultry • Fruits • Other dairy products • Soil
- Other similar samples

- Open pore spear tip sensor with MTC – tough, fast, stable and minimal clogging
- Double junction sensor prolongs electrode lifespan without contaminating samples
- Up to ±0.01 pH accuracy at 0.01 pH resolution
- Non-volatile memory holds your tester settings, even when you run out of batteries
- 3-point push-button calibration with 5 buffer option sets – quick, easy calibrations with no mistake
- Advance power management – 500 hours of operation on one set of batteries
- Waterproof to IP67 standard



Large custom dual-display



Open pore reference junction minimises clogging and delivers fast, stable measurements

Tough open pore spear tip

Double-junction sensor prevents contamination of sample



## ORPTestr® 10 ; ORPTestr® 10BNC

ORP

ORP

Fast, stable and precise – the ORPTestr 10 is designed with advanced microprocessor technology to give you up to  $\pm 2$  mV accuracy across a wide measuring range. User-replaceable double-junction sensor with a wide platinum band provides highly accurate results, even in wet and rugged environments.



Large surface area platinum band provides quick, stable, repeatable results

Valox® strong plastic casing offers superior chemical resistance



ORPTestr 10BNC enables a wider range of specialty electrodes to be used  
*(Refer to page 106 for our ORP electrode selection)*

### More Accurate

- $\pm 2$  mV full scale accuracy
- Wide range of -999 to 1000 mV

### More Savings

- Replaceable double-junction Ag/AgCl polymer sensor
- Advance power management – 500 hours of operation on one set of batteries

### More User-Friendly

- Large custom display LCD
- Non-volatile memory stores your tester settings, even when you run out of batteries
- Waterproof to IP67 standard. So light, it floats!

### Applications

- Chromate reduction • Cyanide oxidation
- Swimming pool water • Pulp bleaching
- Cooling towers • Aquaculture • Drinking water • Other redox applications



Models

pHTestr 30

pHTestr 20

pHTestr 10

EcoTestr pH 2

pHTestr 10BNC

pH Spear

ORPTestr 10

ORPTestr 10BNC



pH/ORP  
Pocket Testers  
Specifications

Measuring Parameter		pH / °C / °F		pH			ORP				
Highlights		0.01 resolution, temp. display		0.01 resolution		0.1 resolution		BNC connection	Open pore, spear tip	Platinum band sensor	BNC connection
pH/ORP	Range	-1.00 to 15.00 pH		-1.0 to 15.0 pH		0.0 to 14.0 pH		-1.00 to 15.00 pH		-999 to +1000 mV	
	Resolution	0.01 pH		0.1 pH		0.01 pH				1 mV	
	Accuracy	±0.01 pH		±0.1 pH		±0.01 pH				±2 mV	
	Cal. Points			3 auto						1 manual	
	Buffer Sets			USA: 4.01 / 7.00 / 10.01 ; NIST: 4.01 / 6.86 / 9.18						-	
Temperature	Range	0 to 50.0 °C / 32.0 to 122.0 °F		-		0 to 50.0 °C / 32.0 to 122.0 °F				-	
	Resolution	0.1 °C / 0.1 °F		-		0.1 °C / 0.1 °F				-	
	Accuracy	±0.5 °C / 0.9 °F		-		-				-	
	Calibration Window	±5 °C / 9 °F from default value		-		0 to 50.0 °C / 32.0 to 122.0 °F				-	
	Temperature Compensation			ATC				MTC		-	
Meter Features	Sensor Type			Double-junction		Single-junction		BNC	Double-junction		BNC
	Sensor Included			Yes				-	Yes		-
	Replacement Sensors			1		-		Many	1		Many
	Non-Volatile Memory							Yes			
	Auto-Off							8.5 mins after last key pressed			
	Operating Temperature							0 to 50 °C			
	LCD Display			Dual-display LCD (2.1 x 2.7 cm)		Single-display LCD (1.7 x 0.7 cm)				Dual-display LCD (2.1 x 2.7 cm)	
	Power							4 x 1.5 V 'A76' micro alkaline batteries (included)			
Dimensions (LxWxH); Weight	Tester	16.5 x 3.8 cm ; 90 g		16.3 x 4.5 x 3 cm ; 90 g		16.5 x 3.8 cm ; 90 g		24 x 3.8 cm ; 103 g		16.5 x 3.8 cm ; 90 g	
	Boxed	18.5 x 6.5 x 5 cm ; 200 g		24.5 x 13.5 x 4.5 cm ; 137 g		18.5 x 6.5 x 5 cm ; 200 g		28 x 7 x 7 cm ; 180 g		18.5 x 6.5 x 5 cm ; 200 g	



<< Aquaculture

>> Wastewater Treatment



>> Food Processing



<< Cooling Towers



**pH/ORP Pocket Testers**

Item	Order Code	Part No.	Parameters			Sensors				Accessories	
			pH	ORP	Temperature	pH Double Junction Sensor (PHSENSOR03DJ)	pH/ORP BNC Connector Sensor (PHSENSORBNC)	pH Double Junction Spear-Tip Sensor (PHSENSOR04)	ORP Double Junction Sensor (ORPSENSORDJ)	Lanyard	Alkaline Button Cell Batteries
pHTestr 30	PHTEST30	01X366903	•		•	•				•	•
pHTestr 20	PHTEST20	01X366902	•			•				•	•
pHTestr 10	PHTEST10	01X366901	•			•				•	•
EcoTestr pH 2	ECPHTEST2	01X460902	•								•
pHTestr 10BNC	PHTEST10BNC	01X366904	•				•			•	•
pH Spear	PHSPEAR	01X366920	•					•			•
ORPTestr 10	ORPTEST10	01X366909		•					•	•	•
ORPTestr 10BNC	ORPTEST10BNC	01X366916		•			•			•	•

**Replacement Sensors & Electrodes**

Used With	Description	Order Code	Part No.
pHTestr 10 / 20 / 30	Replacement double junction sensor	PHSENSOR03DJ	01X106709
EcoTestr pH 2	pH 4.01 buffer solution, 480 ml bottle	ECBU4BT	01X211201
EcoTestr pH 2	pH 7.00 buffer solution, 480 ml bottle	ECBU7BT	01X211202
EcoTestr pH 2	pH 10.01 buffer solution, 480 ml bottle	ECBU10BT	01X211203
EcoTestr pH 2	Storage solution for pH sensor, 480 ml bottle	ECRE005	01X211206
EcoTestr pH 2	Protein removal solution, 480 ml bottle	ECDPGBT	01X211216
EcoTestr pH 2	pH 4.01 buffer sachets (NIST traceable), box of 20 x 20 ml sachets	ECBU4BS	01X223102
EcoTestr pH 2	pH 7.00 buffer sachets (NIST traceable), box of 20 x 20 ml sachets	ECBU7BS	01X223101
EcoTestr pH 2	pH 10.01 buffer sachets (NIST traceable), box of 20 x 20 ml sachets	ECBU10BS	01X223103
EcoTestr pH 2	pH deionized water rinse sachets (NIST traceable), box of 20 x 20 ml sachets	ECRINWT	01X223201
pHTestr 10BNC / ORPTestr 10BNC	Replacement BNC connector sensor	PHSENSORBNC	01X106720
pH Spear	Replacement double junction spear-tip electrode	PHSENSOR04	01X106724
ORPTestr 10	Replacement double junction sensor	ORPSENSORDJ	01X106711
pHTestr 10BNC	General purpose plastic-body single junction gel-filled pH combination electrode, 12 x 90 mm, BNC connector, 1 m cable	ECFC7252101B	01X099412
pHTestr 10BNC	General purpose plastic-body single junction refillable pH combination electrode, 12 x 90 mm, BNC connector, 1 m cable & 10 ml refilling electrolyte	ECFC72521R01B	01X099413
pHTestr 10BNC	General purpose plastic-body double junction gel-filled pH combination electrode, 12 x 90 mm, BNC connector, 1 m cable	ECFC7252201B	01X099417
pHTestr 10BNC	General purpose plastic-body double junction refillable pH combination electrode, 12 x 90 mm, BNC connector, 1 m cable & 10 ml refilling electrolyte	ECFC72522R01B	01X099414
pHTestr 10BNC	Submersible ABS-body gel-filled pH combination electrode; single annular ceramic junction, BNC connector, 3 m cable	ECDA9350603B	93X218879
pHTestr 10BNC	Direct connect epoxy-body gel-filled pH combination electrode, 12 x 90 mm, BNC connector on top of electrode	ECGE7251000B	93X218826
ORPTestr 10BNC	General purpose plastic-body single junction gel-filled ORP electrode, 12 x 90 mm, BNC connector, 1 m cable	ECFC7960101B	01X256612
ORPTestr 10BNC	General purpose plastic-body single junction refillable ORP electrode, 12 x 90 mm, BNC connector, 1 m cable & 10 ml refilling electrolyte	ECFC79601R01B	01X254014
ORPTestr 10BNC	General purpose plastic-body double junction gel-filled ORP electrode, 12 x 90 mm, BNC connector, 1 m cable	ECFC7960201B	01X256613
ORPTestr 10BNC	General purpose plastic-body double junction refillable ORP electrode, 12 x 90 mm, BNC connector, 1 m cable & 10 ml refilling electrolyte	ECFC79602R01B	01X256621

**Accessories**

Used With	Description	Order Code	Part No.
All testrs	Belt-loop soft carrying case for testr	ECPOUCH01	56X201300
All testrs	Alkaline button cell batteries (50 units per pack)	ECBATT14	01X220401

## CyberScan pH 620 ; CyberScan pH 610 ; CyberScan pH 600

pH/ORP/Ion/°C/°F

pH/ORP/°C/°F

pH/ORP/°C/°F

Featuring a large, comprehensive screen with simultaneous display of electrode status, calibration information, temperature and pH or ion measurements at 3-digit resolution! The CyberScan pH 600 comes with advanced wireless communication technology – no wires, no cables. Simply send data from meter to PC with the press of a button.

pH / ORP



Electrode inputs



Wireless data transfer



Waterproof external power input



Complimentary CyberComm software – download data from meter to PC as text or Excel® spreadsheet



IrDA wireless communication

Comprehensive one-glance-tells-all screen display with backlight

Sturdy rubber boot with hinge doubles up as bench top stand

### Applications

- Surface water analysis • Water & wastewater treatment • Boiler blow-down
- Electroplating rinse tanks • Drinking water
- Hydroponics • Printing Industry
- Swimming pools • Others

### Higher Resolution & Accuracy

- High accuracies of up to  $\pm 0.002$  at resolution expandable to 3-decimal places
- Cal-due alarm prevents out-dated calibrations
- Higher full-range accuracy with up to 6 pH and 8 Ion calibration points
- Electrode diagnostic with properties report and response indicator alerts when electrodes require maintenance

### Fuss-Free Data Management

- Non-volatile memory stores up to 500 data sets in GLP-compliant format
- RS232C through LED\*, IrDA wireless communications technology
- Complimentary Eutech CyberComm 600 DAS software
- Auto-logging function automatically logs readings at user-set intervals – great for continuous monitoring

### More User-Friendly

- Intuitive and self-diagnostic
- 20 buffer options with custom and auto buffer recognition
- High/low set-points function for quality control checks – meter warns when readings fall outside set limit
- Password protection security for calibration and set-up menus

\* RS232C (LED) interface adapter available as separate accessory (order code: 01X344201)



# CyberScan pH 310 ; CyberScan pH 300

pH/ORP/°C/°F

pH/ORP/°C

CyberScan pH 310 and pH 300 are IP67 waterproof and ergonomically designed for the rigours of field measurements and the demands of laboratory applications.



Ergonomic design



Rubber sleeve provides better protection against water seepage



Adjustable probe holder



Available in complete kit version

- Waterproof to IP67 standard
- Additional protection against water seepage with rubber sleeve at connector
- Up to 5-point push button calibration
- Selectable automatic/manual temperature compensation
- Dual-display shows pH & temperature readings simultaneously
- Other features include: Custom dual-display LCD, user-customisation on advanced setup mode, auto-off, HOLD function, self-diagnostics, electrode status display

## Expanded Features of CyberScan pH 310

- GLP-compliant date/time stamping
- Up to 6-point push button calibration with DIN buffer set
- Selectable °C/°F
- Extended memory – 50 data sets
- Auto-hold function



## Applications

**Industrial:** Ideal for checks in water conditioning plants, cooling towers, plating and finishing operations, food processing water testing (e.g. HACCP compliance), printing, chemical, manufacturing and water/wastewater treatment.

**Educational:** Useful for most laboratory, ecological studies and other applications.

**Laboratory:** Use in all types of food processing, environmental studies, chemical labs, titrations and quality assurance testing, where GLP data-management is required.



## CyberScan pH 110 ; CyberScan pH 11

Ion/pH/ORP/°C

pH/ORP/°C

User-friendly with advanced features, the CyberScan pH 110 and 11 are self-diagnostic and designed to fit your palm perfectly for effortless one-hand operation.



Complimentary  
CyberComm Data  
Acquisition software\*  
\* CyberScan pH 110 only



RS232C output to printer  
or computer with DAS\*  
\* CyberScan pH 110 only



Available in  
complete kit version

Dual-display  
with temperature  
annunciator

Ergonomically  
designed for  
easy one-hand  
operation

Splashproof  
tactile  
keypad

IP54-rated housing  
protects meter  
against accidental  
water splashes



### Applications

- Food processing • Water & wastewater treatment • Cooling towers • Printing
- Ponds & aquariums • Agriculture & hydroponics • Education institutions
- Electroplating operations (use with ORP electrode)

- Up to 5-point push-button calibration and auto-buffer recognition for quick, easy calibration with minimal mistakes
- Selectable automatic/manual temperature compensation
- Hold function freezes readings for easy reference
- Auto-off conserves energy and lengthens battery life-span
- Easy troubleshooting with comprehensive self-diagnostic messages

### Expanded Features of CyberScan pH 110

- Selectable °C/°F
- Up to 6-point push-button calibration with DIN buffer set
- Direct data transfer via RS232C output – auto data-logging to PC with CyberComm DAS
- Expanded memory stores up to 100 data sets





## Ion 6+ ; pH 6+ ; pH 5+

Ion/pH/ORP/°C    pH/ORP/°C    pH/°C

The new Eutech Ion 6+, pH 6+ and pH 5+ offer you the greatest value-for-money for basic pH and ion measurement needs. Rugged and user-friendly, these no-frill meters come with protective rubber boots and convenient benchtop stands – great for both the lab and the field.



Protective rubber boot

Splashproof tactile keypad for reliable performance

Shock-resistant ABS plastic



Reader-friendly screen display



Protective rubber boot



Available in complete kit version

- Up to 3 calibration points with auto-buffer recognition and choice of USA, NIST and pure water buffer option sets – quick, easy calibration with no mistakes
- Accuracy of up to  $\pm 0.01$  pH and  $\pm 0.5$  °C
- Automatic Temperature Compensation (ATC)
- Non-volatile memory holds your settings, even when meter runs out of batteries
- Hold function freezes readings for easy reference
- Auto-off conserves energy and lengthens battery life-span
- Easy troubleshooting with comprehensive self-diagnostic messages



### Applications

**General:** Ideal for checks in pools and spas, aquariums and hydroponics operations, or anywhere water quality is a concern.

**Industrial:** Cooling towers, food processing, water and wastewater treatment, photo-development, printing and chemical industries.

**Educational:** Useful for most laboratory, ecological studies and other applications.

pH/ORP  
Handheld Meters  
Specifications



Models	CyberScan Dual-Display							Eutech Single-Display				
	pH 620	pH 610	pH 600	pH 310	pH 300	pH 110	pH 11	Ion 6+	pH 6+	pH 5+		
Measuring Parameter	pH / ORP / Ion / °C / °F		pH / ORP / °C / °F			pH / ORP / °C		pH / ORP / °C / °F		pH / ORP / °C		
Highlights	Waterproof, GLP, RS232C, IrDA, Ion, 0.001 pH		Waterproof, GLP, RS232C, IrDA, 0.001 pH		Waterproof, GLP		Expanded memory, RS232C output		Standard handheld		Economic Ion, pH, ORP measurement	
pH	Range	-2.000 to 20.000 pH		-2.00 to 20.00 pH			-2.00 to 16.00 pH		0.00 to 14.00 pH			
	Resolution	0.1 / 0.01 / 0.001 pH		0.1 / 0.01 pH					0.01 pH			
	Accuracy	±0.002 pH		±0.01 pH					±0.01 pH			
	Cal. Points	1 (Offset) to 6-points			Up to 6 (using DIN)		Up to 5		Up to 6 (using DIN)		Up to 5	
	Buffer Sets	USA, NIST, DIN, PWB, Custom			USA, NIST, DIN		USA		USA, NIST, DIN, PWB		USA, NIST	
ORP	Range	±2000.0 mV			±1999 mV			±500 mV		±1000 mV		-
	Rel. mV Range	±2000.0 mV			±1999 mV			-		±500 mV		±1000 mV
	Resolution	0.1 mV			0.1 mV (±199.9 mV) / 1 mV (beyond)			-		-		-
	Accuracy	±0.2 mV + 1 LSD			±0.2 mV / ±2 mV + 1 LSD			-		-		-
Ion	Range	0.001 to 19900		-			-		0.01 to 0.99 / 1.0 to 199.9 / 200 to 1999 ppm		-	
	Resolution	2 or 3 digits		-			-		0.01 / 0.1 / 1 ppm		-	
	Accuracy	0.5 % full scale (monovalent) 1 % full scale (divalent)		-			-		±1 % full scale		-	
	Cal. Points	Up to 8		-			-		Up to 3		-	
Temperature	Range	-10 to 110 °C / 14 to 230 °F			-10 to 110 °C		-10 to 110 °C / 14 to 230 °F		0.0 to 100.0 °C			
	Resolution	0.1 °C / 0.1 °F			0.1 °C		0.1 °C / 0.1 °F		0.1 °C			
	Accuracy	±0.5 °C / ±0.9 °F			±0.5 °C		±0.5 °C / ±0.9 °F		±0.5 °C			
Meter Features	Temperature Compensation	ATC / MTC (0 to 100 °C)										
	GLP	Yes							-			
	Cal-Due Alarm	Yes							-			
	Slope/Offset Display				Yes				-			
	IP67	Yes							-			
	Datalogging	Yes							-			
	Memory	500 data sets			50 data sets		16 data sets		100 data sets		50 data sets	
	Operating Temperature	0 to 50 °C										
	Average/Stability	Yes										
	LCD Display	Dot-matrix LCD with backlight (5.4 x 7.1 cm)			Dual-display LCD (5.8 x 3.3 cm)				Single-display LCD (4.5 x 2.3 cm)			
	Auto-Off	2 to 30 mins after last key pressed			20 mins after last key pressed							
	Input	DC phono sockets, 8-pin connector, BNC			6-pin connector, BNC		DC socket, BNC, 2.5 mm phono socket		BNC, 2.5 mm phono socket			
	Output	IrDA, RS232C (via LED) *			-		RS232C		-			
	Power	4 x 1.5 V 'AAA' alkaline batteries or 9 V DC adapter, 500 mA			4 x 1.5 V 'AAA' alkaline batteries		4 x 1.5 V 'AAA' alkaline batteries or 9 V DC adapter, 200 mA		4 x 1.5 V 'AAA' alkaline batteries			
	Battery Life	> 500 hrs			> 200 hrs		> 700 hrs		> 500 hrs			
Dimensions (LxWxH); Weight	Meter 18.3 x 9.5 x 5.7 cm ; 460 g			19 x 10 x 6 cm ; 320 g		18 x 9 x 4 cm ; 220 g		15.7 x 8.5 x 4.2 cm ; 255 g				
	Boxed 40 x 33 x 10 cm ; 2680 g			40 x 33 x 10 cm ; 2100 g		36 x 28 x 8 cm ; 1555 g						

\* RS232C (LED) interface adapter available as separate accessory (see page 27 for order information)

pH/ORP Handheld Meters

Item	Order Code	Part No.	Parameters				Electrodes							Accessories						
			pH	ORP	Ion	Temperature	*3-in-1" pH/Temp Combi Electrode (ECFC7352901B)	Double Junction pH Electrode (ECFC7252203B)	Double Junction pH Electrode (ECFC7252201B)	Single Junction pH Electrode (ECFC7252101B)	ATC Probe (PHWPTEM03J)	ATC Probe (PHWPTEM01W)	ATC Probe (PHSTEM01P)	CyberComm 600 DAS Software	CyberComm Portable DAS Software	Electrode Holder (x2)	RS232C Cable	Power Adapter	CyberScan Carry Kit Set With Calibration Stds	Economy Carry Kit Set With Calibration Stds
pH 620	ECPHWP62042K	01X415107	•	•	•	•		•			•			•				•	•	
pH 610	ECPHWP61042K	01X415106	•	•		•		•			•			•				•	•	
pH 600	ECPHWP60042K	01X415105	•	•		•		•			•			•				•	•	
pH 310	ECPHWP31002K	01X245304	•	•		•			•			•						•	•	
pH 300	ECPHWP30002K	01X245205	•	•		•			•			•						•	•	
pH 110	ECPH11002K	01X361203	•	•		•			•				•	•	•			•	•	
pH 11	ECPH1102K	01X361103	•	•		•			•					•				•	•	
Ion 6+	ECION602PLUSK	01X256410	•	•	•	•				•				•						•
pH 6+	ECPH603PLUSK	01X245027	•	•		•														•
pH 6+	ECPH602PLUSK	01X245026	•	•		•									•					•
pH 6+	ECPH601PLUSK	01X245028	•	•		•									•					•
pH 5+	ECPH503PLUSK	01X244913	•			•														•
pH 5+	ECPH502PLUSK	01X244912	•			•									•					•

Replacement Electrodes

Used With	Description	Order Code	Part No.
pH 620 / pH 610 / pH 600	ATC probe, 3 m cable	PHWPTEM03J	01X021820
pH 620 / pH 610 / pH 600	ATC probe, 1 m cable	PHWPTEM01J	01X021818
pH 620 / pH 610 / pH 600	General purpose plastic-body double junction gel-filled pH combination electrode, 12 x 90 mm, BNC connector, 3 m cable	ECFC7252203B	01X417010
pH 310 / pH 300	ATC probe, 1 m cable	PHWPTEM01W	01X021807
pH 310 / pH 300 / pH 110 / pH 11	General purpose plastic-body double junction gel-filled pH combination electrode, 12 x 90 mm, BNC connector, 1 m cable	ECFC7252201B	01X099417
pH 110 / pH 11 / Ion 6+ / pH 6+ / pH 5+	ATC probe, 1 m cable	PHSTEM01P	01X021804
Ion 6+ / pH 6+ / pH 5+	General purpose plastic-body single junction gel-filled pH combination electrode, 12 x 90 mm, BNC connector, 1 m cable	ECFC7252101B	01X099412
pH 6+ / pH 5+	General purpose plastic-body *3-in-1" pH/Temperature combination electrode, 12 x 110 mm, BNC connector, 1 m cable	ECFC7352901B	01X218964

Accessories

Used With	Description	Order Code	Part No.
pH 620 / pH 610 / pH 600	CyberScan pH 600 series carry kit set – plastic carry case, buffer solutions (pH 4.01, pH 7.00), storage solution, deionised (rinse) water	ECPHWP600KIT	01X430201
pH 620 / pH 610 / pH 600	100 / 240 VAC SMPS power adapter, 9 V, 6 W, centre +ve, US / UK / EUR / Japan plug	01X030132	01X030132
pH 620 / pH 610 / pH 600	RS232C (LED) interface adapter	91100-85	01X344202
pH 310 / pH 300 / pH 110 / pH 11	CyberScan pH carry kit set – plastic carry case, buffer solutions (pH 4.01, pH 7.00), storage solution, deionised (rinse) water	ECPHWPKIT	01X266801
pH 110 / pH 11	100 / 240 VAC SMPS power adapter, 9 V, 6 W, centre +ve, US / UK / EUR / Japan plug	60X030130	60X030130
pH 110 / pH 11	220 / 230 VAC power adapter (50 / 60 Hz) 2-round pin EUR type, 9 VDC 500 mA	60X030112	60X030112
pH 110 / pH 11	110 / 120 VAC power adapter (50 / 60 Hz) 2-flat pin US type, 9 VDC 500 mA	60X030111	60X030111
pH 110	RS232C communication cable – 9-pin male to 9-pin female connector, 1 m cable	ECCA02M09F09	30X219503
Ion 6+ / pH 6+ / pH 5+	Economy pH carry kit set – plastic carry case, buffer solutions (pH 4.01, pH 7.00), storage solution, deionised (rinse) water	ECECOPHKIT	01X266901
Ion 6+ / pH 6+ / pH 5+	Economy neutral carry kit set – plastic carry case, 4 empty sample bottles (60 ml)	ECECODRYKIT	01X266903
All except 600 series	CyberScan handheld carry pouch	ECPOUCH02	56X201400
12 mm diameter electrode	Electrode holder	15X000700	15X000700



## CyberScan pH 6500 ; CyberScan pH 6000

Dual pH/ORP/Ion/°C/°F

pH/ORP/°C/°F

Presenting Eutech's CyberScan 6000 series, the world's first Windows® CE-driven, full-colour touchscreen bench meter with advanced communication capabilities. Now, you can choose to send and receive information the way you want; using a USB port, wirelessly with IrDA, through a local server via LAN connection, or over the Internet to any computer in the world.



Advanced USB, IrDA connectivity allows extensive host/device communication capabilities



Internet/ethernet-ready connection: send data via email directly from meter!



Application software with technical controls for 21 CFR Part 11  
(software sold separately)

World's first Windows® CE-driven colour touchscreen bench meter



Dual-channel capability – no need for recalibration every time you switch from pH to ISE measurement

Stores up to 1000 data sets for each parameter

### Applications

- Pharmaceutical manufacturing • Research and lab course work • Forensic analysis
- Life sciences and medical researches
- Environmental testing labs • Wastewater and drinking water facilities • Food processing and beverage production

- Auto-calibrates with up to five pH buffers from three standard set and fifteen different buffers; also accepts custom buffers and manual calibration
- Accept standard BNC pH glass electrodes and DIN pH ISFET electrodes – no need for adapters
- Advance real-time on-screen graphing function provides useful indication for specific measurements such as titration
- Extensive set-up screens enable you to customise meter to your needs
- Advanced USB, IrDA connectivity allows extensive host/device communication capabilities
- Secure login for up to 10 users
- Plays media files

### Expanded Features of CyberScan pH 6500

- pH 6500 measures and displays up to two channels simultaneously without cross channel interferences
- 'Direct/indirect', 'known addition/subtraction' and 'analate addition/subtraction' Ion measurement methods in ppm, %, mg/mL and mole/L



1 year warranty for touchscreen display; 3 years warranty for all other meter components.



# Ion 2700

pH/ORP/Ion/°C/°F

Intuitive, self-diagnostic and flexible with advanced set-up options for user-customization, the Eutech 2700 series comes with a large, one-glance-sees-all screen. View pH, Ion or Redox reading together with temperature, electrode status, calibration points, date and time all at once!

pH / ORP



Stability display – faded out and then turns completely black when stable



Bright blue backlight/illuminated display



Non-skid foot pads



Download the latest software from our website  
Coming soon!

- Up to 6-point push button calibration with auto-buffer recognition
- Direct/indirect potentiometry options
- Quick, easy electrode diagnosis with pH slope and offset display
- Non-volatile memory holds up to 500 data points – time and date-stamped for GLP compliance
- Bi-directional RS232 for easy data transfer to computer
- Cal-due alarm – no more out-dated calibrations!
- Auto-logging function for convenient continuous monitoring
- Limit alarm alerts when reading falls out of range
- Password protection for setup and calibration

Use with any BNC ion electrode – sold separately  
Electrode arm and bracket available as separate accessory (order code: 01X321801) – please refer to page 111



### Applications

**Educational:** Useful for most laboratory, ecological studies and other applications.

**Laboratory:** Environmental studies, chemical labs, titrations and quality assurance testing, where GLP data-management is required. Use in all types of food processing.

**pH/ORP**  
Deluxe Bench

pH / ORP



Visual stability display eliminates guesswork



Bright blue backlight/illuminated display



Integrated electrode holder – can be used on either side



Download the latest software from our website  
Coming soon!

**pH 2700**  
pH/ORP/°C/°F

Oversize screen with large fonts yet compact – the new Eutech pH 2700 offers an easy to read screen that says more! View pH or ORP readings, with temperature, electrode status, calibration points, date and time all at once!



**Applications**

**Educational:** Useful for most laboratory, ecological studies and other applications.

**Laboratory:** Environmental studies, chemical labs, titrations and quality assurance testing, where GLP data-management is required. Use in all types of food processing.

- Up to 6-point calibration with auto-buffer recognition
- Quick, easy electrode diagnosis with multiple pH slopes and offset display
- Non-volatile memory holds up to 500 data points – time and date-stamped for GLP compliance
- Comprehensive self-diagnostic messages that makes troubleshooting a breeze
- Cal-due alarm – no more out-dated calibrations!
- Auto-logging function for convenient continuous monitoring
- Password protection for setup and calibration

Electrode arm and bracket available as separate accessory (order code: 01X321801) – please refer to page 111



# Ion 700

pH/ORP/Ion/°C/°F

Ion-selective electrode measurement has never been this easy – or economical! The Ion 700 measures and records up to 100 pH, Ion and/or ORP data points at up to 2 decimal point resolution.

pH / ORP



Oversize display – easy to read



Non-skid foot pads



Splashproof keypad



Quick reference guide

- Large, comprehensive screen that displays readings, calibration points and electrode indicator
- Ready indicator alerts when readings are stable
- Up to 5-point calibration with auto-buffer recognition
- Non-volatile memory holds up to 100 data points
- Integral electrode holder

Use with any BNC ion selective electrode – sold separately  
Electrode arm and bracket available as separate accessory (order code: 01X321801) – please refer to page 111



## Applications

**Educational:** Useful for most laboratory, ecological studies and other applications.

**Laboratory:** Environmental studies, chemical labs, titrations and quality assurance testing. Use in all types of food processing.



## pH 700

pH/ORP/°C/°F

Economical, user-friendly and accurate, the Eutech pH 700 is your ideal choice for routine applications in laboratories, production plants and schools.



Integrated electrode holder – can be used on either side



Splashproof housing; easy to operate keypad



Quick reference guide



### Applications

**Educational:** Useful for most laboratory, ecological studies and other applications.

**Laboratory:** Environmental studies, chemical labs, titrations and quality assurance testing. Use in all types of food processing.

- Large, comprehensive screen that displays readings, calibration points and electrode indicator
- Ready indicator alerts when readings are stable
- Up to 5-point push button calibration with auto-buffer recognition
- Non-volatile memory holds up to 100 data points
- Integral electrode holder

Electrode arm and bracket available as separate accessory (order code: 01X321801) – please refer to page 111





## pH/ORP Bench Meters Specifications



Models		CyberScan Premium Bench		Deluxe Bench		Economy Bench	
		pH 6500	pH 6000	Ion 2700	pH 2700	Ion 700	pH 700
Measuring Parameter		pH / pH FET / ORP / Ion / °C / °F		pH / pH FET / ORP / °C / °F		pH / ORP / °C / °F	
Highlights		Windows® CE dual-channel colour touchscreen, (with pH FET)		Windows® CE single-channel colour touchscreen, (with pH FET)		Graphic LCD with backlight & extensive display	
pH	Range	-2.000 to 20.000 pH		-2.000 to 20.000 pH		0.00 to 14.00 pH	
	Resolution	0.1 / 0.01 / 0.001 pH		0.1 / 0.01 / 0.001 pH		0.01 pH	
	Accuracy	±0.1 / 0.01 / 0.002 pH + 1 LSD		±0.002 pH + 1 LSD		±0.01 pH + 1 LSD	
	Cal. Points	Up to 5		Up to 6		Up to 5	
	Buffer Sets	USA, NIST, Euro, Custom		USA, NIST, DIN, User 1, User 2, Custom		USA, NIST	
ORP	Range	±2000.0 mV		±2000.0 mV		±2000 mV	
	Rel. mV Range	±2000.0 mV		±2000.0 mV		±2000 mV	
	Resolution	0.1 mV		0.1 mV		0.1 mV (±199.9 mV) / 1 mV (beyond)	
Accuracy	±0.2 mV		±0.2 mV		±0.2 mV (±199.9 mV) / 2 mV (beyond)		
Ion	Concentration	1 x 10 <sup>-6</sup> to 9.99 x 10 <sup>10</sup> ppm	–	0.001 to 19999 ppm (± 2000 mV)	–	0.01 to 2000 ppm (± 2000 mV)	–
	Resolution	2 / 3 / 4 digits	–	2 / 3 digits	–	0.01 / 0.1 / 1 ppm	–
	Accuracy	±0.17 % full scale (monovalent) ±0.34 % full scale (divalent)	–	0.5 % full scale (monovalent) 1 % full scale (divalent)	–	±0.5 % full scale (monovalent) ±1 % full scale (divalent)	–
	Cal. Points	2 to 5	–	2 to 8	–	2 to 5	–
	Incremental Methods	KA, KS, AA, AS	–	–	–	–	–
Temperature	Range (Meter)	-5.0 to 105.0 °C / 23.0 to 221.0 °F		0.0 to 100.0 °C / 32.0 to 212.0 °F		0.0 to 100.0 °C / 32.0 to 212.0 °F	
	Resolution	0.1 °C / 0.1 °F		0.1 °C / 0.1 °F		0.1 °C / 0.1 °F	
	Accuracy	±0.2 °C / ±0.3 °F		±0.3 °C / ±0.5 °F		±0.5 °C / ±0.9 °F	
Meter Features	Temperature Compensation	ATC / MTC (0 to 100 °C)		ATC / MTC (0 to 100 °C) (pH only)		ATC / MTC (0 to 100 °C) (pH only)	
	GLP	Yes		Yes		–	
	Slope/Offset Display	Yes		Yes		–	
	Datalogging	Yes		Yes		–	
	Memory	Up to 1000 data sets per parameter		500 data sets		100 data sets	
	Operating Temperature	5 to 45 °C / 41 to 113 °F		5 to 45 °C / 41 to 113 °F		5 to 45 °C / 41 to 113 °F	
	LCD Display	Windows® CE colour touchscreen (11.5 x 15.4 cm)		Graphic LCD with backlight (5.9 x 7.8 cm)		Custom dual-display LCD (5.6 x 7.5 cm)	
	Input	DC socket, 2 BNC, 2 phono (ATC), FET, SD card, USB-A, USB-B, RJ45, audio	DC socket, BNC, phono (ATC), FET, SD card, USB-A, USB-B, RJ45, audio	DC socket, BNC, phono (ATC), phono (reference), phono (RS232)		DC socket, BNC, phono (ATC), phono (reference)	
	Output	USB, IrDA, RS232C		RS232C		–	
	Power	9 V DC adapter, 3.3 A (100 / 240 VAC, SMPS)		9 V DC adapter, 1.3 A (100 / 240 VAC, SMPS)		9 V DC adapter, 1.3 A (100 / 240 VAC, SMPS)	
Dimensions (LxWxH); Weight	Meter	16.5 x 23.5 x 8.9 cm ; 1100 g		17.5 x 15.5 x 6.9 cm ; 650 g		17.5 x 15.5 x 6.9 cm ; 650 g	
	Boxed	49 x 28 x 16 cm ; 3330 g		30.8 x 23.5 x 12.4 cm ; 1800 g		30.8 x 23.5 x 12.4 cm ; 1800 g	

# pH/ORP

## Bench Meters Ordering Information

### pH/ORP Bench Meters

Item	Order Code	Part No.	Parameters					Electrodes						Accessories						
			pH	pHFET	ORP	Ion	Temperature	pH Electrode (EC620130)	pH Electrode (ECFC7252101B)	pH Electrode (ECFG7370101B)	pH Electrode (ECFG7350401B)	ATC Probe (EC62019)	ATC Probe (PH5TEMB01P)	CyberComm 6000 21 CFR Part 11 Software	CyberComm Pro V2.4 DAS Software	Integral Electrode Holder	RS232C Cable	Power Adapter	pH Electrode Refill Solution, 60 ml	Calibration Sachets
pH 6500	ECPH650042SC	01X373710	•	•	•	•	•	•					•	•	•	•	•		•	
pH 6500	ECPH650042S	01X373705	•	•	•	•	•	•					•		•	•	•			•
pH 6000	ECPH600042SC	01X373512	•	•	•	•	•	•					•		•	•	•			•
pH 6000	ECPH600042S	01X373505	•	•	•	•	•	•					•		•	•	•			•
Ion 2700	ECION270042GS	01X543904	•			•	•							•						•
Ion 2700	ECION270040S	01X543903	•			•	•								•					•
pH 2700	ECPH270042GS	01X543902	•			•	•							•						•
pH 2700	ECPH270040S	01X543901	•			•	•								•					•
Ion 700	ECION70040S	01X541609	•			•	•								•					•
pH 700	ECPH70042GS	01X541605	•			•	•							•						•
pH 700	ECPH70040S	01X541603	•			•	•								•					•

### Replacement Electrodes

Used With	Description	Order Code	Part No.
pH 6500 / pH 6000	ATC probe, 1 m cable	EC62019	01X306504
pH 6500 / pH 6000	General purpose glass body open pore refillable pH electrode, 12 x 140 mm & 10 mL refilling electrolyte	EC620130	01X218972
pH 2700	Glass-body double junction Ag/AgCl refillable pH electrode, 12 x 110 mm, BNC connector, 1 m cable	ECFG7370101B	93X218819
pH 700	General purpose plastic-body single junction gel-filled pH combination electrode, 12 x 90 mm, BNC connector, 1 m cable	ECFC7252101B	01X099412
pH 2700 / pH 700	ATC probe	PH5TEMB01P	93X052911

### Accessories

Used With	Description	Order Code	Part No.
pH 6500 / pH 6000	RS232C communication cable – 9-pin male to 9-pin female connector, 1 m cable	ECCA02M09F09	30X219503
pH 6500 / pH 6000	CyberComm 6000 (21 CFR Part 11 compliant CyberScan 6000 series application software)	ECDAS6000	01X415501
pH 6500 / pH 6000	100 / 240 VAC SMPS power adapter, 9 V, 3.3 A, centre -ve, with 2-pin power cord	60X030128	60X030128
pH 2700	100 / 240 VAC SMPS power adapter, 9 V, 6 W	60X426401	60X426401
pH 700	100 / 240 VAC SMPS power adapter, 9 V, 6 W	60X030130	60X030130
pH 6500 / pH 6000	Secure Digital (SD) memory card, 256 MB, Sandisk	01X419901	01X419901
pH 2700	pH electrode refill solution, reference, saturated potassium chloride, 60 ml	01X211297	01X211297
All meters	Electrode stand with swivel arm	ECPHELSTDC	01X081600



<< Chemical Labs

>> Pharmaceutical Industry



## Conductivity/ Total Dissolved Solids/Salinity



A measure of the impurities in water supplies for domestic and industrial use.

**Tester:**

1. ECTestr 11+; 11
2. TDSTestr® 11+; 11
3. SaltTestr® 11
4. EcoTestr EC High; Low
5. EcoTestr TDS High; Low
6. EcoTestr Salt

**Handheld:**

1. CyberScan COND 610
2. CyberScan COND 600
3. CyberScan CON 400
4. CyberScan CON 110
5. CyberScan CON 11
6. COND 6+
7. TDS 6+
8. Salt 6+

**Bench:**

1. CyberScan CON 6000
2. CON 2700
3. CON 700



## About Conductivity, TDS & Salinity Measurement

### Introduction to Conductivity, TDS and Salinity

Electrical Conductivity (EC) meters measure the capacity of ions in an aqueous solution to carry electrical current. As the ranges in aqueous solutions are usually small, the basic units of measurements are milliSiemens/cm (mS/cm) and microSiemens/cm (µS/cm).

Solution	Conductivity
Absolute pure water	0.055 µS/cm
Power plant boiler water	1.0 µS/cm
Good city water	50 µS/cm
Ocean water	53 mS/cm
Distilled water	0.5 µS/cm
Deionised water	0.1 - 10 µS/cm
Demineralised water	0 - 80 µS/cm
Drinking water	0.5 - 1 mS/cm
Wastewater	0.9 - 9 mS/cm
Seawater	53 mS/cm
10 % NaOH	355 mS/cm
10 % H <sub>2</sub> SO <sub>4</sub>	432 mS/cm
31 % HNO <sub>3</sub>	865 mS/cm

Conductivity is used widely to determine the level of impurities in water supplies for domestic consumption as well as industrial use. Industries that employ this method include the chemical, semi-conductor, power generation, hospitals, textile, iron and steel, food and beverage, mining, electroplating, pulp and paper, petroleum and marine industries.

Specific applications include chemical streams, demineraliser output, reverse osmosis, steam boilers, condensate return, waste streams, boiler blowdown, cooling towers, desalination, laboratory analysis, fruit peeling and salinity level detection in oceanography.

**Eutech offers a wide range of conductivity meters for these various applications. Models include the ECTestr series, COND 6+, CyberScan handheld CON 11 and CON 110, CyberScan waterproof CON 400 and CON 410 and CyberScan bench meters CON 510, CON 1500, CON 6000 as well as the handheld multi-parameters PC 10, PC 300, PC 510 and colour touchscreen research-grade bench series PC 6000, PC 6500 and PCD 6500.**

The total TDS is a mass estimate and is dependent on the mix of chemical species as well as the concentration while conductivity is only dependent on the concentration of chemical species. Some applications require the measurement of Total Dissolved Solids (TDS) in mg/L, parts per million (ppm) or parts per thousand (ppt). The TDS concentration can be obtained by multiplying the conductivity value with a factor which is empirically determined.

**Eutech offers meters that allow the direct reading of TDS values. These include the TDSTestr® series, TDS 6+, CyberScan standard handheld CON 11, CON 110 and waterproof handheld CON 410. Bench meters for advanced level laboratory research are the CyberScan CON 510, CON 1500 and colour touchscreen research-grade CON 6000.**

Salinity measurements are common in industries like agriculture, aquaculture, hydroponics, food, pools and spas where it is necessary to monitor the salt level constantly. The values are usually read in parts per thousand (ppt) or % (1 ppt = 1 gram per litre).

**The Eutech salinity pocket testers SaltTestr® series are specially developed to provide direct readings in these applications.**

### The Principle of Conductivity Measurement

The principle by which instruments measure conductivity is simple – two plates are placed in the sample, a potential is applied across the plates (normally a sine wave voltage), and the current is measured. Conductivity (G), the inverse of Resistivity (R) is determined from the voltage and current values according to Ohm's law.

$$G = I/R = I \text{ (amps)} / E \text{ (volts)}$$

Since the charge on ions in solution facilitates the conductance of electrical current, the conductivity of a solution is proportional to its ion concentration. In some situations, however, conductivity may not correlate directly to concentration. The graphs below illustrate the relationship between conductivity and ion concentration for two common solutions. Notice that the graph is linear for sodium chloride solution, but not for highly concentrated sulfuric acid. Ionic interactions can alter the linear relationship between conductivity and concentration in some highly concentrated solutions.

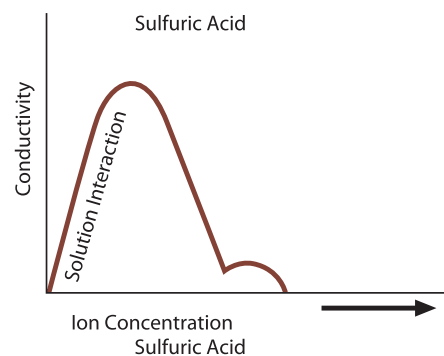
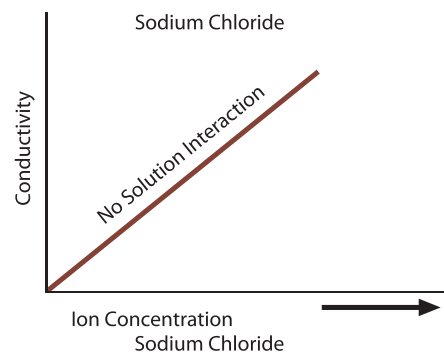

### Units of Measurement

The basic unit of conductivity is the Siemens (S), formerly called the mho. Since cell geometry affects conductivity values, standardized measurements are expressed in specific conductivity units (S/cm) to compensate for variations in electrode dimensions. Specific conductivity (C) is simply the product of measured conductivity (G) and the electrode cell constant (L/A), where L is the length of the column of liquid between the electrode and A is the area of the electrodes.



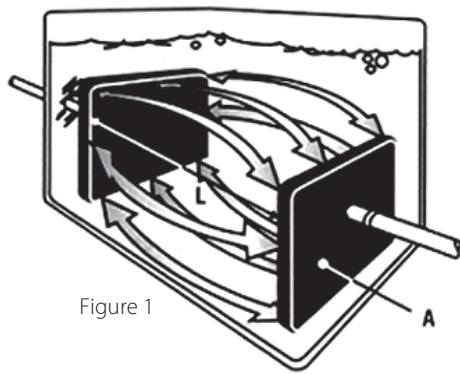

Figure 1

$$C = G \times (L/A)$$

If the cell constant is  $1 \text{ cm}^{-1}$ , the specific conductivity is the same as the measured conductivity of the solution. Although electrode shapes vary, an electrode can always be represented by an equivalent theoretical cell.

### Conductivity Temperature Compensation

Conductivity measurements are temperature dependent. The degree to which temperature affects conductivity varies from solution to solution and can be calculated using the following formula:

$$G_t = G_{t_{std}} \{1 + \alpha(T - T_{std})\}$$

where:

- $G_t$  = Conductivity at measured Temperature  $T$  in  $^{\circ}\text{C}$ ;
- $G_{t_{std}}$  = Conductivity at Reference (Normalisation) Temperature  $T_{std}$  in  $^{\circ}\text{C}$ ;
- $\alpha$  = Temperature Coefficient of solution at  $T_{std}$  in  $^{\circ}\text{C}$ ;
- $T_{std}$  = Reference or Normalisation Temperature in  $^{\circ}\text{C}$

All meters have either fixed or adjustable automatic temperature compensation referenced to a standard temperature – usually  $25^{\circ}\text{C}$ . Most meters with fixed temperature compensation use  $\alpha$  of 2% per  $^{\circ}\text{C}$  (the approximate  $\alpha$  of NaCl solutions at  $25^{\circ}\text{C}$ ). Meters with adjustable temperature compensation let you to adjust the  $\alpha$  to more closely match the  $\alpha$  of your measured solution.

### Conductivity Meter Calibration and Cell Maintenance

Conductivity meters and cells should be calibrated to a standard solution before using. When selecting a standard, choose one that has the approximate conductivity of the solution to be measured.

A polarized or fouled electrode must be cleaned to renew the active surface of the cell. In most situations, hot water with a mild liquid detergent is an effective cleanser. Acetone easily cleans most organic matter, and chlorine solutions will remove algae, bacteria or molds. To prevent cell damage, abrasives or sharp objects should not be used to clean an electrode. A cotton bud works well for cleaning but care must be taken not to widen the distance of cell.

### Conductivity Cells

Most conductivity meters have a 2-cell electrode available in either dip or flow-through styles. The electrode surface is usually platinum, titanium, gold-plated nickel, or graphite. The 4-cell electrode uses a reference voltage to compensate for any polarization or fouling of the electrode plates. The reference voltage ensures that measurements indicate actual conductivity independent of electrode condition, resulting in higher accuracy for measuring pure water.

**The Eutech EC620165 4-cell conductivity electrode (cell constant  $K=1.0$ ) with in-built ATC and DIN connector is available for use with the bench meters CON 1500, PC 6000, PC 6500 and PCD 6500. ECCONSEN9203J 4-cell conductivity electrode with ATC and 3 m cable is available for COND 600, COND 610, PCD 650 and CD 650 handheld meters.**

### Important Features to Consider in a Conductivity Meter

- **Auto-Ranging**  
Meter automatically selects the appropriate range for measurement. There is no need to change the dial, multiply values on the display, or turn the potentiometer.
- **Temperature Compensation**  
A cell with built-in temperature sensor allows the meter to make adjustments to the conductivity or TDS readings based on changes in solution temperature.
- **TDS Conversion Factor**  
When a solution does not have a similar ionic content to natural water or salt water, then a TDS conversion factor is needed to automatically adjust the readings.
- **Adjustable Temperature Coefficients**  
The TDS of certain samples, such as alcohols and pure water, are affected by changes in temperature. An adjustable temperature coefficient allows the user to compensate for temperature changes on the solution being measured.
- **Adjustable Cell Constant**  
Adjusts the reading on the display to reflect use of a cell with a constant other than  $k=1.0 \text{ cm}^{-1}$ .

**Eutech's wide range of conductivity meters incorporates these features for consistent, accurate and reliable measurements.**



## ECTestr 11+ ; ECTestr 11 ; TDSTestr® 11+ ; TDSTestr® 11

Conductivity/°C/°F

Total Dissolved Solids/°C/°F

Combining the ranges of three testers into one, the Eutech multi-range ECTestr 11 Series and TDSTestr 11 Series now measure a wider conductivity range from pure water to waste water. User-friendly features such as simultaneous temperature display, auto-ranging option, adjustable TDS factor and automatic temperature compensation make conductivity and TDS measurements on-the-go quick and easy!

Conductivity / TDS / Salinity



User-replaceable sensor



Unique cup-style design of '+' series allows you to hold small volumes of sample

\* For ECTestr 11+ & TDSTestr 11+

Simultaneous temperature display



Simultaneous temperature display



Sensor element made from industrial grade SS316 stainless steel type to protect against harsh samples

VALOX® sensor casing for superior chemical durability

### Accurate & Reliable

- ECTestr 11 series measures up to 20.00mS; TDSTestr 11 series measures up to 20.00ppt
- Up to 3-point calibration for higher accuracy – choose auto-calibration for quick, effortless calibration!
- Selectable TDS factor (0.4 to 1.00)\*
- ±1 % full scale accuracy

\* For TDSTestr 11+

### Long Lasting

- Sensor elements made with industrial-grade SS316 stainless steel ensures superior chemical durability. 11+ models come with unique cup-type sensors, made with Valox® casing to protect against harsh samples
- Reduced operating cost – use tester body again and again with user-replaceable sensor
- Rugged and waterproof to IP67 standards. So light, it floats!

### User-Friendly

- Auto-ranging option for convenient measurements in wide-range samples.
- Toggle between °C / °F easily with the press of a button
- Non-volatile memory retains calibration settings even when batteries run out – no need to recalibrate each time you change batteries

### Applications

- Water & wastewater treatment • Boiler blow-down • Electroplating rinse tanks
- Drinking water • Hydroponics • Printing Industry • Aquaculture • Aquariums & fish farms • Swimming pools • Others



# SaltTestr® 11

Salinity/°C/°F

Eutech's latest SaltTestr 11 now comes with a new temperature display in °C and °F for easy reference during your salinity testing. Waterproof to IP67 standard, the SaltTestr 11 assures high accuracy readings even in harsh field conditions, from aquaculture settings to food production applications.

Unlike other conventional testers, the SaltTestr 11 offers  $\pm 1\%$  full scale accuracy

IP67 waterproof casing – so light it floats!

Sensor element made from industrial grade SS316 stainless steel type to protect against harsh samples



User-replaceable sensor

## More User-Friendly

- Direct temperature readout in °C and °F
- Large screen display
- Battery-level indicator
- Non-volatile memory

## High Accuracy

- $\pm 1\%$  full scale accuracy
- Automatic Temperature Compensation (ATC)

## More Savings

- Replaceable sensors
- Advanced power-conserving design



## Applications

**Routine Testing:** For quick, accurate Salinity measurements in laboratories, field and schools.

**Water Quality Testing:** Ideal for salt levels in brines, pool water, aquaculture systems, aquariums (marine fish) and fish ponds (koi), food processing and healthcare industries.

EcoTestr EC High & EC Low ; EcoTestr TDS High & TDS Low ; EcoTestr Salt  
Conductivity Total Dissolved Solids Salinity

The Eutech EcoTestr conductivity, TDS and Salinity series come with rugged, sturdy stainless steel pin sensors, giving you quick, reliable measurements in a wide range of applications. Ideal for use in hydroponics gardening, fish-farming, pools, electroplating and other water/wastewater applications.

Conductivity / TDS / Salinity



Click-lock battery compartment – simply lift and remove cover to replace batteries. No additional tools required



Tactile switch keypad lasts longer than ordinary keypad

Large, upright LCD with parameter display and battery level indicator

Easy push-button calibration. Microprocessor-powered tester requires no screwdriver for calibration

Non-volatile memory retains tester settings even when batteries run out



**Applications**

- Water & wastewater treatment
- Environmental monitoring • Education
- Hydroponics • Agriculture • Aquaculture & aquariums • Pools & spas • Food & beverage manufacturing • Cooling towers
- Electroplating • Printing
- Photo-development & more!

- Up to  $\pm 1\%$  full scale accuracy
- Single-point, auto-calibration – quick, easy calibrations at the press of a button
- Manual calibration option for better accuracy with near-to-sample calibrations
- EcoTestr TDS series features adjustable TDS factor from 0.4 to 1.0



## Conductivity/ TDS/Salinity Pocket Testers Specifications

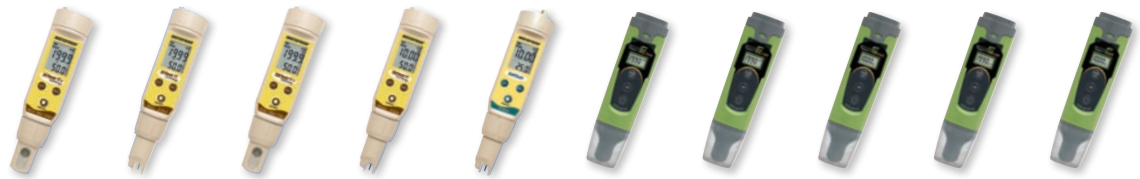

Models		Waterproof Large Dual-Display Pocket Testers					EcoTestrs				
		ECTestr 11+	ECTestr 11	TDSTestr 11+	TDSTestr 11	SaltTestr 11	EC High	EC Low	TDS High	TDS Low	Salt
Measuring Parameter		Conductivity / °C / °F		TDS / °C / °F		Salinity / °C / °F	Conductivity		TDS		Salinity
Highlights		Multi-range	Dual-range	Multi-range	Dual-range	Dual-display	Economical, large, upright display				
Conductivity	Range	.. to 200.0 µS .. to 2000 µS .. to 20.00 mS	.. to 2000 µS .. to 20.00 mS	–	–	–	.. to 19.90 mS	.. to 1990 µS	–		
	Resolution	0.1 µS 1 µS 0.01 mS	10 µS 0.10 mS	–	–	–	0.1 mS	10 µS	–		
	Accuracy	±1 % full scale		–	–	–	±1 % full scale (±2 % above 10 mS)	±1 % full scale	–		
TDS	Range	–	–	.. to 100.0 ppm* .. to 1000 ppm* .. to 10.00 ppt (depending on TDS factor)	.. to 1000 ppm* .. to 10.00 ppt	–	–	.. to 10.00 ppt	.. to 1990 ppm	–	
	Resolution	–	–	0.1 ppm 1 ppm 0.01 ppt	10 ppm 0.10 ppt	–	–	0.1 ppt	10 ppm	–	
	Accuracy	–	–	±1 % full scale		–	–	±1 % full scale (±2 % above 5 ppt)	±1 % full scale	–	
	Factor	–	–	0.40 to 1.00 (selectable)		–	–	0.50 to 1.00 (selectable)	0.4 to 1.0 (selectable)	–	
Cal. Points	3 auto or 3 manual	2 auto or 2 manual	3 manual	2 manual	1 manual						
Salinity	Range	–				.. to 10.00 ppt	–				
	Resolution	–				0.10 ppt	–				
	Accuracy	–				±1 % full scale	–				
	Cal. Points	–				1	–				
Temperature	Range	0 to 50.0 °C / 32.0 to 122.0 °F					–				
	Resolution	0.1 °C / 0.1 °F					–				
	Accuracy	±0.5 °C / ±0.9 °F + 1 LSD					–				
	Calibration Window	±5.0 °C / ±9.0 °F				±0.5 °C / ±0.9 °F	–				
Meter Features	Temperature Compensation	ATC (0 to 50 °C / 32 to 122 °F)									
	Sensor Type	Cup	Dip	Cup	Dip						
	Replaceable Sensor	Yes					–				
	Temperature Coefficient	2 % per °C, fixed									
	Normalization Temperature	25.0 °C, fixed									
	Non-Volatile Memory	Yes									
	IP67	Yes									
	Operating Temperature	0 to 50 °C									
	Auto-Off	8.5 mins after last key pressed									
	LCD Display	Custom dual-display (2.1 x 2.7 cm)					3½ digit single display				
	Power	4 x 1.5 V 'A76' micro alkaline batteries (included)									
Battery Life	> 150 hrs										
Dimensions (LxWxH); Weight	Tester	16.5 x 3.8 cm ; 90 g					16.3 x 4.5 cm ; 90 g				
	Boxed	18.5 x 6.5 x 5 cm ; 200 g									

• 1 mS/cm = 1000 µS/cm (µS: microSiemens / mS: miliSiemens) • 1 ppt = 1000 ppm (ppm: parts per million / ppt: parts per thousand) \* Max. 200.0 ppm and 2000 ppm based on TDS factor 1.0

## Conductivity/TDS/Salinity Pocket Testers Ordering Information

### Conductivity/TDS/Salinity Pocket Testers

Item	Order Code	Part No.	Parameters				Sensors		Accessories	
			Conductivity	TDS	Salinity	Temperature	Cup Type Sensor	2-Pin Type Sensor	Lanyard	Alkaline Button Cell Batteries
ECTestr 11+	ECTEST11PLS	01X377229	•			•	•		•	•
ECTestr 11	ECTEST11	01X377228	•			•		•	•	•
TDSTestr 11+	TDSTEST11PLS	01X377234		•		•	•		•	•
TDSTestr 11	TDSTEST11	01X377233		•		•		•	•	•
SaltTestr 11	SALTTEST11	01X377232			•	•		•	•	•
EcoTestr EC High	ECOECTESTHIGH	01X477102	•					•		•
EcoTestr EC Low	ECOECTESTLOW	01X477101	•					•		•
EcoTestr TDS High	ECOTDSTESTHIGH	01X477104		•				•		•
EcoTestr TDS Low	ECOTDSTESTLOW	01X477103		•				•		•
EcoTestr Salt	ECOSALTTEST	01X477105			•			•		•

### Replacement Sensors & Electrodes

Used With	Description	Order Code	Part No.
ECTestr 11 / TDSTestr 11 / SaltTestr 11	2-pin type replacement sensor	ECTDSSSENSOR	01X229713
ECTestr 11+ / TDSTestr 11+	Cup type replacement sensor	ECTDSSSENSORPLUS	01X229714

### Accessories

Used With	Description	Order Code	Part No.
All testrs	Belt-loop soft carrying case for testr	ECPOUCH01	56X201300
All testrs	Alkaline button cell batteries (50 units per pack)	ECBATT14	01X220401
SaltTestr 11 / EcoTestr Salt	5 ppt NaCl standard solution	ECNACL5PPT	01X211230
SaltTestr 11	25 ppt NaCl standard solution	ECNACL25PPT	01X211231
SaltTestr 11	45 ppt NaCl standard solution	ECNACL45PPT	01X211232
EcoTestr EC High	2764 µS/cm KCl calibration solution, 480 ml bottle	ECCON2764BT	01X211214
EcoTestr EC High	12.88 mS/cm KCl calibration solution, 480 ml bottle	ECCON1288BT	01X211210
EcoTestr EC Low	100 µS/cm KCl calibration solution, 480 ml bottle	ECCON100BT	01X211217
EcoTestr EC Low	1413 µS/cm KCl calibration solution, 480 ml bottle	ECCON1413BT	01X211207
EcoTestr TDS High	3.00 ppt 442 calibration solution, 480 ml bottle	EC4423000BT	01X109101
EcoTestr TDS Low	300 ppm 442 calibration solution, 480 ml bottle	EC442300BT	01X109102
EcoTestr TDS Low	1000 ppm 442 calibration solution, 480 ml bottle	EC4421000BT	01X109104

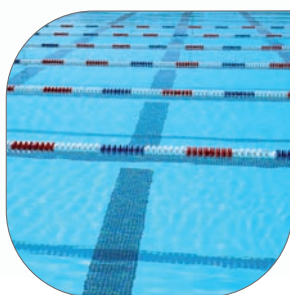

<< Drinking Water >> Aquaculture  
<< Swimming Pools >> Industrial Process Water

## CyberScan COND 610 ; CyberScan COND 600

Conductivity/TDS/Salinity/Resistivity/°C/°F Conductivity/TDS/°C/°F

View readings, calibration and electrode status data all in one screen view – the CyberScan COND 600 series comes with advanced wireless communications technology for seamless data transfer from meter to PC. Meter also accepts and auto-detects 2-cell and 4-cell conductivity probes for pure water to wastewater applications.



Comprehensive multi-data screen display with backlight

High/low alarm limits

User-friendly set-up menu with intuitive soft-key operation

IP67 waterproof



Wireless data transfer



Complimentary Cybercomm software – download data from meter to PC as text or Excel® spreadsheet



Velcro strap for firmer grip



Kit set comes with 4-cell conductivity electrode

Conductivity / TDS / Salinity

### Wider Measuring Range

- Up to 5 Conductivity ranges in one meter with convenient auto-ranging capabilities
- ±1 % full scale accuracy at 3-decimal resolution
- Measures pure water with pure water temperature coefficient option (applicable to COND 610 only)

### User-Friendly

- Backlit screen with multi-data display – convenient for working in dark areas
- Cal-due alarm for periodic calibration updates

### Advanced Data Management

- Meter logs reading automatically within seconds of measurement
- Password protection security for calibration and set-up menus
- GLP-compliant with time and date-stamping
- RS232C through LED\*, IrDA wireless communications technology

\*RS232C (LED) interface adapter available as separate accessory (order code: 01X344201)



### Applications

**Environmental:** Use to test water quality, monitor health of aquatic ecosystems, survey surface and ground water drinking supplies and to meet EPA regulations.

**Industrial:** Ideal for checking quality of plant water intake and discharge, wastewater and water treatment, recirculating systems and industrial process systems, water conditioning plants and chemical process verification.

**Aquaculture:** Use to monitor water conditions in catfish and shrimp farming, game stocking ponds, ornamental fish tanks and ponds as well as other fish farming applications.



## CyberScan CON 400

Conductivity/TDS/°C/°F

Waterproof to IP67, the CyberScan CON 400 delivers lab-accurate results stamped with time and date for GLP-compliant research.



Ergonomic design for that perfect palm fit



Available in complete kit version



### Applications

• Water quality testing • Geological and ecological testing • Cooling towers • Boiler water • Printing • Brines • Swimming pools and spas • Agriculture and aquaculture • Aquariums • Hydroponics • Fertilizers • Schools and laboratories

- Conveniently auto-ranging with up to 5-point push-button calibration
- Measures TDS in addition to Conductivity and Temperature in °C and °F
- Adjustable TDS factor for direct derivation of TDS values
- Selectable cell constant
- GLP-compliant
- Selectable automatic/manual temperature compensation
- Hold function freezes readings for easy reference
- Auto-off conserves energy and lengthens battery life-span
- Non-volatile memory holds up to 50 data sets even when you run out of batteries





## CyberScan CON 110 ; CyberScan CON 11

Conductivity/TDS/°C/°F

Conductivity/TDS/°C

The economy CyberScan CON 110 and 11 are cost-effective, easy to use and self-diagnostic for easy trouble-shooting. Meters are uniquely designed to fit your palm perfectly for effortless one-hand operation.



Dual-display with temperature annunciator

Ergonomically designed for easy one-hand operation

Splashproof keypad

Conductivity electrode with built-in ATC and designed for minimal bubble entrapment

IP54-rated housing protects meter against dust and water splashes



Complimentary CyberComm Data Acquisition software



Direct data printout via RS232C



Adjustable electrode holder

- Selectable automatic and manual calibration options
- Full-range accuracy with up to 5-point push-button calibration
- More accurate measurements with user-customisable options for normalisation temperature, TDS factor and temperature coefficient
- Non-volatile memory holds up to 50 data sets. Meter settings remain even when you run out of batteries
- Hold function freezes readings for easy reference
- Auto-off conserves energy and lengthens battery life-span
- Direct data transfer via RS232C output – auto data-logging to PC with CyberComm DAS

### Expanded Features of CyberScan CON 110

- Convenient data transfer to a printer or PC with RS232C output
- One-glance monitoring of electrode performance with electrode data display
- Expanded memory holds up to 100 data sets



### Applications

**General:** Monitor dissolved solids or Conductivity levels quickly and easily in laboratories, field, schools and educational environments.

**Industrial:** Use for testing pollution control, water treatment, and water hardness. Also useful for checking cooling towers, boiler water, fountain solutions in printing operations, brines, swimming pools, whirlpools and rinse water.

**Agricultural:** Use for checking aquariums, fish farms, hydroponics, and fertilizer/chemical concentrations.

## COND 6+ ; TDS 6+

Conductivity/°C    TDS/°C

Sturdy and economical – the Eutech COND 6+ and Eutech TDS 6+ are no-frills handhelds perfect for basic water testing needs. The meters are rugged, sturdy and come with protective rubber boots and hinges that conveniently double up as benchtop stands.

Conductivity / TDS / Salinity



Reader-friendly screen display



Splashproof keypad



Convenient benchtop stand



Rubber boot protects against knocks and hits

IP54-rated housing protects against dust and water splashes

Conductivity electrode with built-in ATC and designed for minimal bubble entrapment

### Applications

**Routine Testing:** For quick, accurate Conductivity or TDS checks in laboratories, field and schools.

**Environmental/Agricultural:** Useful in nutrient and fertilizer checks in hydroponics and agricultural industries.

**Water Quality Testing:** For analysing water, hard water, untreated water, industrial and rinse water, drinking water, effluent water, pool water and incoming process water. Ideal for all types of quality assurance, printing industries and water quality testing.

- Up to 5-point push-button calibration with auto-buffer recognition – quick, easy calibration with no mistakes
- ±1 % full scale accuracy
- Selectable automatic/manual temperature compensation
- Auto-ranging for Conductivity measurements
- Adjustable TDS factor for direct derivation of values
- Non-volatile memory holds meter settings, even when batteries run out
- Easy troubleshooting with comprehensive self-diagnostic messages



## Salt 6+

Salinity/°C

With sturdy rubber boot, splash-proof keypad, large custom LCD and rugged carrying case, salinity testing on the go is a breeze with the Eutech Salt 6+.



Rubber boot protects against knocks and hits

IP54-rated housing protects against water splashes

Splashproof keypad

- Measures in ppt and %
- Quick and easy push-button calibration
- User customisation for normalisation temperature and temperature coefficient
- Electrode with built-in ATC designed for minimal air bubble entrapment during measurement
- Rugged all-in-one meter kit available
- Other features include: HOLD function, auto-off, self-diagnostics



### Applications

**Routine Testing:** For quick, accurate Salinity measurements in laboratories, field and schools.

**Water Quality Testing:** Ideal for salt levels in brines, pool water, aquaculture systems, aquariums (marine fish) and fish ponds (koi), food processing and healthcare industries.



**Conductivity/TDS/Salinity**  
Handheld Meters Specifications

Conductivity / TDS / Salinity

**Conductivity/  
TDS/Salinity  
Handheld Meters  
Specifications**



Models		CyberScan Dual-Display					Eutech Single-Display		
		COND 610	COND 600	CON 400	CON 110	CON 11	COND 6+	TDS 6+	Salt 6+
Measuring Parameter		Conductivity / TDS / Salinity / Resistivity / °C / °F	Conductivity / TDS / °C / °F		Conductivity / TDS / °C / °F	Conductivity / TDS / °C	Conductivity / °C	TDS / °C	Salinity / °C / °F
Highlights		Waterproof, GLP, RS232C, IrDA, linear & pure TC	Waterproof, GLP, RS232C, IrDA, linear TC	Waterproof, GLP	Expanded memory, RS232C output	Standard handheld	Economical CON measurement	Economical TDS measurement	High accuracy over a wide Salinity range
Conductivity	Range	.. to 2.000 µS 2.000 to 300.0 µS 300.0 µS to 4.000 mS 4.000 to 40.00 mS 40.00 to 500.0 mS	.. to 2.000 µS 2.000 to 300.0 µS 300.0 µS to 4.000 mS 4.000 to 40.00 mS 40.00 to 200.0 mS	.. to 19.99 µS 19.9 to 199.9 µS 199 to 1999 µS 2.00 to 19.99 mS 20.0 to 199.9 mS					
	Resolution	0.01 µS / 0.1 µS / 0.001 mS / 0.01 mS / 0.1 mS		0.05 % full scale					
	Accuracy	±1 % full scale + 1 LSD							
TDS	Range (Depending On TDS Factor)	.. to 2.000 ppm 2.000 to 300.0 ppm 300.0 ppm to 4.000 ppt 4.000 to 40.00 ppt 40.00 to 500.0 ppt	.. to 2.000 ppm 2.000 to 300.0 ppm 300.0 ppm to 4.000 ppt 4.000 to 40.00 ppt 40.00 to 200.0 ppt	.. to 10.00 ppm ** 10.0 to 100.0 ppm 100 to 1000 ppm 1.00 to 10.00 ppt 10.0 to 100.00 ppt	.. to 9.99 ppm ** 10.0 to 99.9 ppm 100 to 999 ppm 1.00 to 9.99 ppt 10.0 to 99.9 ppt			.. to 9.99 ppm ** 10.0 to 99.9 ppm 100 to 999 ppm 1.00 to 9.99 ppt 10.0 to 99.9 ppt	
	Resolution	0.01 ppm / 0.1 ppm / 0.001 ppt / 0.01 ppt / 0.1 ppt		0.05 % full scale	0.05 % full scale				
	Accuracy	±1 % full scale + 1 LSD							
Salinity	Range	.. to 0.770 ppm 0.770 to 143.3 ppm 143.3 ppm to 2.138 ppt 2.138 to 23.64 ppt 23.64 to 80.00 ppt							
	Resolution	0.01 ppm / 0.1 ppm / 0.001 ppt / 0.01 ppt							0.1 ppt / 0.01 %
	Accuracy	±1 % full scale + 1 LSD							
Resistivity	Range	2.000 to 25.00 Ω 25.00 to 250.0 Ω 250.0 to 3.333 kΩ 3.333 to 500.0 kΩ 500.0 kΩ to 20.00 MΩ							
	Resolution	0.01 Ω / 0.1 Ω / 0.001 Ω / 0.1 Ω / 0.01 MΩ							
	Accuracy	1 % full scale + 1 LSD							
Cal. Points		4 (1 per range) auto, 5 (1 per range) manual		5 (1 per range) manual	4 (1 per range) auto, 5 (1 per range) manual			5 (1 per range) manual	
Temperature	Range	-10.0 to 110 °C / 14.0 to 230 °F		0.0 to 100.0 °C / 32.0 to 212 °F					-10.0 to 110 °C
	Resolution			0.1 °C / 0.1 °F					0.1 °C
	Accuracy			±0.5 °C / ±0.9 °F					±0.5 °C
	Compensation			ATC / MTC (0 to 80 °C)					ATC/MTC (0 to 50 °C)
	Normalization	15 to 30 °C		20.0 or 25.0 °C					20.0 °C & 25.0 °C (selectable)
Operating Temp.	0 to 50 °C								
Meter Features	Temperature Coefficient	Linear & pure	Linear	0.0 to 10.0 %			0.0 to 3.0 %		0.0 to 3.0 %
	GLP	Yes							
	Cal-Due Alarm	Yes							
	IP67	Yes							
	Datalogging	Yes							Yes
	Memory	500 data sets		50 data sets	100 data sets	50 data sets			
	Cell Constant	0.010 to 10.000		0.1, 1.0, 10.0					
	LCD Display	Dot-matrix LCD with backlight (5.4 x 7.1 cm)		Dual-display LCD (5.8 x 3.3 cm)			Single-display LCD (4.5 x 2.3 cm)		
	Auto-Off	2 to 30 mins after last key pressed		20 mins after last key pressed					
	Auto Hold	Yes							
	Input	DC phono sockets, 8-pin connector		6-pin connector	DC socket, 6-pin connector		BNC, 2.5 mm phono socket		
	Output	IrDA, RS232C (via LED) *		-		RS232C		-	
	Power	4 x 1.5 V 'AAA' alkaline batteries or 9 V DC adapter, 500 mA		4 x 1.5 V 'AAA' alkaline batteries	4 x 1.5 V 'AAA' alkaline batteries or 9 V DC adapter, 200 mA		4 x 1.5 V 'AAA' alkaline batteries		
Battery Life	> 200 hrs		> 100 hrs	> 200 hrs		> 100 hrs			
Dimensions (LxWxH); Weight	Meter	18.3 x 9.5 x 5.7 cm ; 460 g		19 x 10 x 6 cm ; 320 g	18 x 9 x 4 cm ; 220 g		15.7 x 8.5 x 4.2 cm ; 255 g		
	Boxed	40 x 33 x 10 cm ; 2680 g		40 x 33 x 10 cm ; 2100 g					36 x 28 x 8 cm ; 1555 g

\* 1 mS/cm = 1000 µS/cm (µS: microSiemens / mS: milliSiemens) • 1 ppt = 1000 ppm (ppm: parts per million / ppt: parts per thousand) \*\* Maximum 199.9 ppt depending on factor setting  
\* RS232C (LED) interface adapter available as separate accessory (see page 49 for order information)

Conductivity/TDS/Salinity Handheld Meters

Item	Order Code	Part No.	Parameters					Electrodes			Accessories					
			Conductivity	TDS	Salinity	Resistivity	Temperature	4-Cell Conductivity Electrode (CONSEN9203J)	Conductivity Electrode (CONSEN91W)	Conductivity Electrode (CONSEN91B)	CyberComm 600 DAS Software	CyberComm Portable DAS Software	Electrode Holder	RS232C Cable	Power Adapter	CyberScan Carry Kit Set With Calibration Stds
COND 610	ECCONWP61043K	01X418307	•	•	•	•	•	•			•			•	•	
COND 600	ECCONWP60043K	01X418304	•	•			•	•			•			•	•	
CON 400	ECCONWP40003K	01X251410	•	•			•								•	
CON 110	ECCON11003K	01X366309	•	•			•		•			•			•	
CON 11	ECCON1103K	01X366305	•	•			•		•			•			•	
COND 6+	ECCON603PLUSK	01X289425	•				•			•						•
TDS 6+	ECTDS603PLUSK	01X289427		•			•			•						•
Salt 6+	ECSALT603PLUSK	01X289429			•		•			•						•*

\* Economy Salinity carry kit set – plastic carry case, 5 ppt, 25 ppt, 45 ppt NaCl standard solutions, deionised rinse water

Replacement Electrodes

Used With	Description	Order Code	Part No.
COND 610 / COND 600	4-cell epoxy body Conductivity electrode, ATC, cell constant K=1.0, 12 x 120 mm, 8-pin connector, 3 m cable	CONSEN9203J	01X244723
COND 610 / COND 600	2 stainless steel rings ultem-body Conductivity electrode, ATC, cell constant K=1.0, 16 x 144 mm, 8-pin connector, 1 m cable	CONSEN91J	01X244721
CON 400 / CON 110 / CON 11	2 stainless steel rings ultem-body Conductivity electrode, ATC, cell constant K=1.0, 16 x 144 mm, 6-pin connector, 1 m cable	CONSEN91W	01X244702
COND 6+ / TDS 6+ / Salt 6+	2-stainless steel rings ultem-body Conductivity electrode, ATC, cell constant K=1.0, 16 x 144 mm, BNC connector, 1 m cable	CONSEN91B	01X244701

Accessories

Used With	Description	Order Code	Part No.
COND 610 / COND 600	CyberScan CON 600 series carry kit set – plastic carry case, 442 standard solutions (1413 mS, 12.88 mS KCl, 3000 ppm), deionised rinse water	ECCONWP600KIT	01X430202
COND 610 / COND 600	100 / 240 VAC SMPS power adapter, 9 V, 6 W, centre +ve, US / UK / EUR / Japan plug	01X030132	01X030132
COND 610 / COND 600	RS232C (LED) interface adapter	91100-85	01X344202
CON 400 / CON 110 / CON 11	CyberScan Conductivity / TDS carry kit set – plastic carry case, 442 standard solutions (1413 mS, 12.88 mS KCl, 3000 ppm), deionised rinse water	ECCONWPKIT	01X266802
CON 110 / CON 11	100 / 240 VAC SMPS power adapter, 9 V, 6 W, centre +ve, US / UK / EUR / Japan plug	60X030130	60X030130
CON 110	RS232C communication cable – 9-pin male to 9-pin female connector, 1 m cable	ECCA02M09F09	30X219503
COND 6+ / TDS 6+	Economy Conductivity / TDS carry kit set – plastic carry case, 442 standard solutions (1413 mS, 12.88 mS KCl, 3000 ppm), deionised rinse water	ECECOCONKIT	01X266902
12 mm diameter electrode	Electrode holder	15X000700	15X000700
All except 600 series	CyberScan handheld carry pouch	ECPOUCH02	56X201400



## CyberScan CON 6000

Conductivity/TDS/Salinity/Resistivity/°C/°F

Send data to any computer in the world directly from your meter! Eutech's CyberScan 6000 Series is the world's first Windows CE-driven touchscreen meter series with internet/ethernet-ready connection. With its comprehensive communications capabilities, you can choose to send data in any format – via the USB port, wirelessly using IrDA, or email via the internet. Ideal for comprehensive pharmaceutical researches, forensic analysis and other advanced lab work.

Conductivity / TDS / Salinity



Application software with technical controls for 21 CFR Part 11  
(software sold separately)



Multiple communications capabilities

World's first Windows® CE-driven colour touchscreen bench meter



Detachable electrode holder can be fixed on either side of meter

Internet/ethernet-ready connection

Real-time on-screen graphing

Touchscreen efficiency

Stores up to 1000 data sets per parameter

### Applications

- Pharmaceutical manufacturing • Research and lab course work • Forensic analysis
- Life sciences and medical researches
- Environmental testing labs • Wastewater and drinking water facilities • Food processing and beverage production

- Single-point and multi-point standardisation for Conductivity, Resistivity, TDS and Salinity measurements using 2-cell and 4-cell probes
- Advanced real-time on-screen graphing function provides useful indication for specific measurements
- Extensive setup screens enable you to customise meter to your needs, e.g. cell constant, temperature coefficient, TDS factor, alarm limits and other functions
- Windows® CE-driven, full-colour touchscreen provides unmatched ease of use in operations and setups with user-friendly icons, user prompts and context specific 'help' screens
- Advanced USB, IrDA connectivity allows extensive host/device communication capabilities
- Secure log-in for up to ten users



1 year warranty for touchscreen display; 3 years warranty for all other meter components.



## CON 2700

Conductivity/TDS/Salinity/Resistivity/°C/°F

Featuring auto-standardization, auto-calibration and auto-ranging capabilities, the Eutech CON 2700 accepts 2-cell and 4-cell electrodes, allowing a broad range of measurement at up to  $\pm 1\%$  full scale accuracy. Meter comes with a multi-data screen that shows Conductivity readings, temperature, electrode status, calibration points, date and time all at once.



Integrated electrode holder

Bright blue backlight/illuminated display

Splashproof housing and keypad



Stability display – faded out and then turns completely black when stable



Large informative display



Download the latest software from our website  
Coming soon!



Non-skid foot pads

- Choose auto-calibration with preset values for quick easy calibration, or manual multi-point calibration for greater accuracy
- Easy standardization with auto-standardization feature – detect the exact cell constant value of your electrodes with the press of a button
- Quick, easy electrode diagnosis with the effective cell constants display
- Replatinization in 5 minutes with the built-in replatinization circuit
- Non-volatile memory holds up to 500 data points – time and date-stamped for GLP compliance
- Bi-directional RS232 for easy data transfer to computer
- Cal-due alarm – no more out-dated calibrations!
- Auto-logging function for convenient continuous monitoring
- Limit alarm alerts when reading falls out of range
- Password protection for setup and calibration

Electrode arm and bracket available as separate accessory (order code: 01X321801) – please refer to page 111



### Applications

- Environmental studies
- Chemical laboratories
- Quality assurance testing
- Food science
- Ecological studies
- Education institution

Conductivity / TDS / Salinity

## CON 700

Conductivity/TDS/°C/°F

The economy Eutech CON 700 offers years of reliable, accurate and consistent performance. User-friendly features make the instrument an ideal research partner in laboratories, production plants and schools.



Larger display



Electrode arm can be used on either side



Splashproof keypad



Non-skid foot pads



Integrated electrode holder

Fast response

Quick reference guide

### Applications

- Environmental studies • Chemical laboratories • Quality assurance testing
- Food science • Ecological studies
- Education institution

- Large, comprehensive screen that displays readings, calibration points and electrode indicator
- Ready indicator alerts when readings are stable
- Selectable cell constant
- Auto-ranging across 5 conductivity ranges
- Up to 5-point push button calibration
- Non-volatile memory holds up to 100 data points
- Integral electrode holder

Electrode arm and bracket available as separate accessory (order code: 01X321801) – please refer to page 111



Model	CyberScan Premium Bench	Deluxe Bench	Economy Bench
	CON 6000	CON 2700	CON 700

## Conductivity/ TDS/Salinity Bench Meters Specifications



Measuring Parameter		Conductivity / TDS / Salinity / Resistivity / °C / °F	Conductivity / TDS / Salinity / Resistivity / °C / °F	Conductivity / TDS / °C / °F	
Highlights		Windows® CE, single-channel color touchscreen	Graphic LCD with backlight & extensive display	Large LCD with dual display	
Conductivity	Range	.. to 200.0 µS 200.0 µS to 2.000 mS 2.000 to 20.00 mS 20.00 to 500.0 mS	0.050 µS to 500.0 mS	.. µS to 200.0 mS	
	Resolution	0.001 / 0.01 / 0.1 µS 0.001 / 0.01 / 0.1 mS	0.01 / 0.1 µS 0.001 / 0.01 / 0.1 mS	0.01 / 0.1 / 1 µS 0.01 / 0.1 mS	
	Accuracy	±0.5 % full scale + 1 digit	±1 % full scale	±1 % full scale	
	Cal. Points	4 auto, 4 manual	Up to 5		
TDS	Range (Depending On TDS Factor)	.. to 200.0 ppm 200.0 to 2000 ppm 2.000 to 20.00 ppt 20.00 to 500.0 ppt Depending on TDS factor	0.050 mg/L to 500.0 g/L	.. to 100.0 ppt @ 0.5 fact (200.0 @ 1 factor)	
	Resolution	0.001 / 0.01 / 0.1 ppm, 0.001 / 0.01 / 0.1 ppt	0.01 / 0.1 ppm 0.001 / 0.01 / 0.1 ppt	0.01 / 0.1 / 1 ppm 0.01 / 0.1 ppt	
	Accuracy	±0.5 % full scale + 1 digit	±1 % full scale	±1 % full scale	
	Cal. Points	4 auto, 4 manual	Up to 5		
Salinity (Salt)	Range	0 to 90 ppt over 4 ranges	0 to 80.0 ppt	–	
	Resolution	0.1 / 0.01 / 0.001 ppt	0.01 / 0.1 ppm 0.001 / 0.01 / 0.1 ppt	–	
	Accuracy	±0.5 % full scale + 1 digit	±1 % full scale	–	
	Cal. Points	4 auto, 4 manual	Up to 5	–	
Resistivity	Range	0 to 19.99 kΩ 20.00 to 199.9 kΩ 200.0 kΩ to 1.999 MΩ 2.000 to 100.0 MΩ	2.000 Ω to 20.0 MΩ	–	
	Resolution	0.1 / 0.01 / 0.001 kΩ, 0.01 / 0.001 MΩ	0.01 / 0.1 Ω, 0.001 / 0.1 kΩ, 0.01 MΩ	–	
	Accuracy	±0.5 % full scale + 1 digit	±1 % full scale	–	
	Cal. Points	4 auto, 4 manual	Up to 5	–	
Temperature	Range (Meter)	-5.0 to 105.0 °C / 23.0 to 221.0 °F	0.0 to 100.0 °C / 32.0 to 212.0 °F		
	Resolution		0.1 °C / 0.1 °F		
	Accuracy	±0.2 °C / ±0.3 °F	±0.3 °C / ±0.5 °F		
	Coefficient (Per °C)	0.000 to 10.000 %	Linear & pure; 0.000 to 10.000 %		
	Normalization		15.0 to 30.0 °C / 59.0 to 86.0 °F		
Meter Features	Temperature Compensation	ATC / MTC (-5 to 100 °C) (meter)	ATC / MTC		
	GLP		Yes	–	
	Cell Constant	0.1 / 1.0 / 10.0	0.010 to 10.000		
	Datalogging		Yes	–	
	Memory	Up to 1000 data sets per parameter	500 data sets		
	Operating Temperature		5 to 45 °C / 41 to 113 °F		
	LCD Display	Windows® CE colour touchscreen (11.43 x 15.24 cm)	Graphic LCD with backlight (5.9 x 7.8 cm)	Custom dual-display LCD (5.6 x 7.5 cm)	
	Input	DC socket, DIN, SD card, USB-A, USB-B, RJ45, audio	DC socket, 8-pin DIN (2-cell or 4-cell), RS232		
	Output	USB, IrDA, RS232C	RS232		
Power	9 V DC adapter, 3.3 A (100 / 240 VAC, SMPS)	9 V DC adapter, 1.3 A (100 / 240 VAC, SMPS)			
Dimensions (LxWxH); Weight	Meter: 16.5 x 23.5 x 8.9 cm ; 1100 g Boxed: 49 x 28 x 16 cm ; 3330 g	17.5 x 15.5 x 6.9 cm ; 650 g 30.8 x 23.5 x 12.4 cm ; 1800 g			

• 1 mS/cm = 1000 µS/cm (µS: microSiemens / mS: miliSiemens) • 1 ppt = 1000 ppm (ppm: parts per million / ppt: parts per thousand)



## Conductivity/TDS/Salinity Bench Meters Ordering Information

### Conductivity/TDS/Salinity Bench Meters

Item	Order Code	Part No.	Parameters					Electrodes			Accessories				
			Conductivity	TDS	Salinity	Resistivity	Temperature	4-Cell Conductivity Probe (EC620165)	4-Cell Conductivity Probe (93X219065)	2-Cell Conductivity Electrode (CONSEN9501D)	CyberComm 6000 DAS Software	Integral Electrode Holder	RS232C Cable	Power Adapter	Calibration Sachets
CON 6000	ECCON600043SC	01X373811	•	•	•	•	•	•			•	•	•	•	•
CON 6000	ECCON600043S	01X373805	•	•	•	•	•	•				•			•
CON 2700	ECCON270043S	01X543905	•	•	•	•	•		•			•			•
CON 700	ECCON70043S	01X543401	•	•			•			•		•			•

### Replacement Electrodes

Used With	Description	Order Code	Part No.
CON 6000	4-cell epoxy-body Conductivity electrode, ATC, cell constant K=1.0, DIN connector, 1 m cable	EC620165	93X219046
CON 2700	4-cell, epoxy-body, graphite sensor, "Bulls Eye" Conductivity electrode, ATC, cell constant=1.0, 12 x 120 mm, 8-pin DIN connector, 1 m cable	93X219065	93X219065
CON 700	2 stainless steel rings ultem-body Conductivity electrode, ATC, cell constant K=1.0, 16 x 144 mm, 8-pin connector, 1 m cable	CONSEN9501D	01X466601

### Accessories

Used With	Description	Order Code	Part No.
CON 6000	RS232C communication cable – 9-pin male to 9-pin female connector, 1 m cable	ECCA02M09F09	30X219503
CON 6000	CyberComm 6000 (21 CFR Part 11 compliant CyberScan 6000 series application software)	ECDAS6000	01X415501
CON 6000	100 / 240 VAC SMPS power adapter, 9 V, 3.3 A, centre -ve with 2-pin power cord	60X030128	60X030128
CON 2700	100 / 240 VAC SMPS power adapter, 9 V, 6 W	60X426401	60X426401
CON 700	100 / 240 VAC SMPS power adapter, 9 V, 6 W	60X030130	60X030130
CON 6000	Secure Digital (SD) memory card, 256 MB, Sandisk	01X419901	01X419901

<< Water Analysing  
<< Cooling Tower Water



>> School Laboratories  
>> Recirculating Systems

## Dissolved Oxygen



The measure of the amount of gaseous oxygen dissolved in a solution.

**Handheld:**

1. CyberScan DO 600
2. CyberScan DO 300
3. CyberScan DO 110
4. DO 6+

**Bench:**

1. CyberScan DO 6000
2. DO 2700
3. DO 700

## About Dissolved Oxygen Measurement

### What is Dissolved Oxygen?

Dissolved Oxygen (DO) is a measure of the amount of dissolved gaseous oxygen in a solution. Some gases, such as ammonia, carbon dioxide and hydrogen chloride, react chemically with water to form new compounds. However, gases such as nitrogen and oxygen merely dissolve in water without chemically reacting with it, and exist as microscopic bubbles between water molecules.

There are two main ways in which dissolved oxygen occurs naturally in water: From the surrounding atmosphere, where oxygen in the surrounding air dissolves readily when mixed into water, up to saturation, during water movements; via photosynthesis when oxygen is produced by aquatic plants and algae as a by-product of photosynthesis. The amount of oxygen dissolved in water is usually measured in percent saturation, or expressed as a concentration in milligrams per litre water. Accurate measurement of dissolved oxygen is essential in processes where oxygen content affects reaction rates, process efficiency or environmental conditions, such as biological wastewater treatment, wine production, bio-reactions, environmental water testing.

### Basic Principle in DO Measurement

In theory, the amount of DO in a solution is dependent on three factors, namely temperature, salinity and atmospheric pressure.

#### 1. Water Temperature

Solubility of oxygen reduces as temperature increases. Hence, the colder the water, the more dissolved oxygen it contains. Since temperature affects both the solubility and diffusion rate of oxygen, temperature compensation is necessary for any standardized DO measurements.

**All Eutech DO meters come with automatic temperature compensation for accurate readings even in varying temperature conditions.**

#### 2. Salinity

The amount of dissolved oxygen increases as salinity level decreases. In other words, freshwater holds more oxygen than saltwater. Since the presence of dissolved salts limits the amount of oxygen that can dissolve in water, the relationship between the partial pressure and concentration of oxygen varies with the salinity of the sample.

**Eutech meters feature manual salinity correction to compensate for variations in ionic concentration. Simply enter the salinity of the sample in parts per thousand (ppt) to ensure the correct DO measurements.**

#### 3. Atmospheric Pressure

There is a direct proportional relationship between the solubility of dissolved oxygen and the surrounding atmospheric pressure. As pressure decreases with increase in altitude, the amount of dissolved oxygen found in water reduces.

To ensure that your dissolved oxygen is not affected by atmospheric pressure, Eutech meters come with manual barometric pressure compensation, with an Atmospheric Pressure Correction Chart included in the manuals for convenient referencing.

**Eutech DO instruments automatically compensate for temperature, salinity and barometric pressure. The salinity value and barometric pressure are either measured by the instrument or entered by the user.**

### DO Electrodes

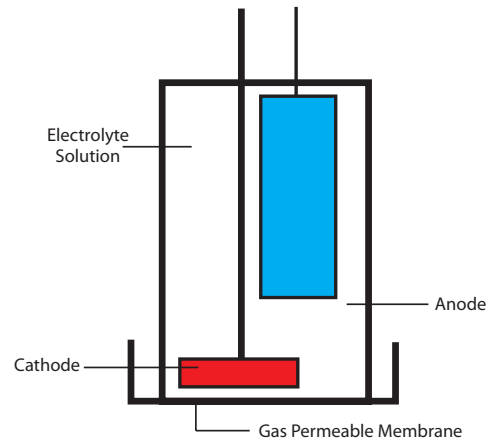

The measurement of DO requires a special DO electrode that is made up of an anode, a cathode, electrolyte solution and a gas permeable membrane. The material of the membrane is specially selected to permit oxygen to pass through. Oxygen is consumed by the cathode which will create a partial pressure across the membrane. Oxygen then diffuses into the electrolyte solution. In short, a DO meter actually measures the pressure caused by movements of oxygen molecules in water or any other medium. Currently, galvanic and polarographic electrodes are the predominant methods for measuring dissolved oxygen.

**The Galvanic Cell** consists of two metals, the positive anode and the negative cathode, connected by a salt bridge between the individual half-cells. As the metal electrodes leave electrons behind as they dissolve in the electrolyte. The different properties of the two metals causes them to dissolve at different rates, hence a pressure is created when the number of electrons in either side of the cell differs. The pressure is translated into an electric current proportion to the oxygen concentration in the electrolyte if an electrical circuit is created between the two electrodes. The galvanic electrode does not need polarising time and is able to assume operation immediately.

During this process, ions of the more active anode are transferred through the electrolyte to the less active cathode, and deposited there as a plating. In this way the anode is corroded. When the anode material eventually corrodes away, the potential drops and the current halts.

**Galvanic electrodes are available with most Eutech Instruments DO meters such as the DO 6+, CyberScan DO 110 and DO 300.**

**The Polarographic Cell** consists of two electrodes placed in the electrolyte: One with fixed potential called the reference electrode, and the other with a variable potential called the polarizable electrode. As voltage is applied to the polarizable electrode, a redox reaction occurs, where electrons break away from the electrode to bond with oxygen in the electrolyte. The rate at which the electrons break



away from the polarizable electrode is linearly proportionate to the amount of oxygen available in the electrolyte, hence this movement of electrons is representative of the amount of dissolved oxygen left in the electrolyte.

The advantage of a polarographic cell is that the cathode remains intact. The current flow of the polarographic cell is also linearly proportional to the amount of oxygen present in the electrolyte, enabling the cell to provide highly accurate measurements at low oxygen levels.

**Polarographic self-stirring DO/BOD probes are available for use with the Eutech CyberScan research-grade bench meters DO 6000 and PCD 6500 in US EPA-approved auto five-day BOD testings.**

## BOD & COD

The BOD test measures the molecular oxygen utilized in the biodegradation of organic material and the oxidation of inorganic material. By measuring the amount of oxygen dissolved in samples at the beginning and end of a specified incubation period, the relative oxygen requirements of wastewaters, effluents, and polluted waters can be determined.

$$\text{BOD}_t \text{ (mg/L)} = \frac{D_1 - D_2}{P}$$

$\text{BOD}_t$  = Oxygen uptake during incubation period t

$D_1$  = DO of diluted sample immediately after preparation (mg/L)

$D_2$  = DO of diluted sample after incubation period t (mg/L)

$P$  = Decimal volumetric fraction of sample used

BOD is similar to the Chemical Oxygen Demand (COD), which also measures relative oxygen-depletion. However, the possible presence of non-biologically oxidisable may render the COD test to be less accurate.

The COD Test is often used to measure the amount of organic compounds in surface water by measuring the amount of oxygen required to oxidize and break down an organic compound into carbon dioxide, ammonia and water. The basis of the COD test is that anything can be oxidized into carbon dioxide using a strong oxidizing agent in acidic environments. A blank sample, created by adding all reagents to distilled water is usually used as a control in COD measurements.

Both the BOD and COD tests are means to measure the relative oxygen-depletion effect of a waste contaminant, and are widely used to monitor pollution levels. The BOD test measures the oxygen demand of biodegradable pollutants whereas the COD test measures the oxygen demand of biodegradable pollutants plus the oxygen demand of non-biodegradable oxidizable pollutants.

However, because COD measures everything that can be chemically oxidised and not just the level of biologically active organic matter, the possibility of non-biological oxidizable may render the COD Test as a less accurate method compared to the BOD method.



<< Shrimp Farming

>> Water Treatment



**DO**  
CyberScan Waterproof Handheld



Wireless data transfer



Waterproof external power input



Complimentary Cybercomm 600 software – download data from meter to PC as text or Excel® spreadsheet



Sturdy rubber boot doubles up as meter stand

**Applications**

**Aquacultural:** Use to monitor oxygen levels in catfish and shrimp farming; game stocking ponds; ornamental fish tanks and ponds; and in other fish farming applications.

**Industrial:** Ideal for checks on the quality of plant water intake and discharge, wastewater and water treatment, recirculating systems and industrial process systems.

**Environmental:** Use to test water quality, monitor health of aquatic ecosystems, survey surface and ground water drinking supplies, and meet EPA regulations.

**Educational:** Ideal for quick, accurate DO readings in laboratories and schools.

## CyberScan DO 600

Dissolved Oxygen/°C/°F

Fast, intuitive and powerful – the CyberScan DO 600 offers one of the widest measurement ranges and biggest memory spaces in the DO handheld market today. Data-transfer is easy with incorporated IrDA wireless communications technology: No wires, no cables. Send data with the press of a button!



Large backlit screen with multi-data display and intelligent prompt messages

Intuitive soft-key operation

Rugged and IP67 waterproof

**Wide Measurement Range**

- Measures oxygen concentration up to 90.00 mg/L and saturation up to 600.0 %
- Accurate readings even in varying conditions with Temperature, Salinity and Barometric Pressure Compensation

**User-Friendly**

- Cal-due alarm for periodic calibration updates
- IP67 waterproof design for applications in harsh environments
- High/low set-points function for quality control checks – meter warns when readings fall outside set limit
- Built-in barometer for auto-pressure correction

**Advanced Data-Management**

- Auto-logging function that automatically records up to 500 data sets in GLP-compliant format
- RS232C through LED\*, IrDA wireless communications technology

\*RS232C (LED) interface adapter available as separate accessory (order code: 01X344201)



Dissolved Oxygen

# CyberScan DO 300

Dissolved Oxygen/°C/°F

Designed to meet the rigours of outdoor field measurement, Eutech's waterproof CyberScan DO 300 is IP67-rated waterproof and even floats on water for easy retrieval. Its galvanic probe requires no warm-up time, delivers repeatable, stable readings and calls for almost no maintenance.



- Custom dual-display LCD that shows DO readings (in ppm, mg/L or % saturation) and temperature readings (in °C and °F)
- Non-volatile memory stores up to 50 data sets with temperature readings
- Auto-compensation of Salinity and Barometric Pressure with manual input
- Independent 100 % and zero adjustment calibrations
- Adjustable backlit display
- GLP-compliant
- Self-diagnostic for easy trouble-shooting
- IP67 waterproof housing



## Applications

- Aquaculture (shrimp & catfish farming)
- Ponds and aquariums
- Water quality testing
- Water and wastewater treatment
- Recirculating systems and industrial process systems
- Geological and ecological testing
- Monitoring surface and ground drinking water (in compliance with EPA regulations)
- Schools and laboratories



## CyberScan DO 110

Dissolved Oxygen/°C/°F

Accurate with sophisticated yet user-friendly features, the CyberScan DO 110 delivers repeatable, stable measurements with its unique galvanic electrode – no warm-up time required!



Complimentary  
CyberComm Data  
Acquisition software



RS232C output allows  
direct data transfer  
from meter to PC



Adjustable hinge  
acts as a table stand

Dual-display  
with temperature  
annunciator

Ergonomic slim  
design for that  
perfect palm fit

Galvanic electrode  
requires no  
warm-up time

IP54-rated  
housing protects  
meter against  
water splashes



### Applications

**Aquacultural:** Use to monitor oxygen levels in catfish and shrimp farming; game stocking ponds; ornamental fish tanks and ponds; and in other fish farming applications.

**Industrial:** Ideal for checks on the quality of plant water intake and discharge, wastewater and water treatment, recirculating systems and industrial process systems.

**Environmental:** Use to test water quality, monitor health of aquatic ecosystems, survey surface and ground water drinking supplies, and meet EPA regulations.

**Educational:** Ideal for quick, accurate DO readings in laboratories and schools.

- Custom dual-display LCD that shows DO readings in mg/L (ppm) or % saturation and temperature in °C and °F
- Auto-compensation of Salinity and Barometric Pressure with manual input
- Stores up to 100 data sets with temperature readings
- Direct data transfer via RS232C output – auto data-logging to PC with CyberComm DAS
- Independent 100 % and zero adjustment calibrations
- One-glance monitoring of electrode performance with electrode data display
- Self-diagnostic for easy trouble-shooting
- IP54 splashproof housing



## DO 6+

Dissolved Oxygen/°C

The Eutech DO 6+ offers high performance at an economical price. Rugged and user-friendly, this no-frill meter comes with a protective rubber boot and a convenient benchtop stand. Measures in mg/L (ppm), or % saturation.



Reader-friendly screen display

IP54-rated housing protects against dust and water splashes



Splashproof keypad



Protective rubber boot

Dissolved Oxygen

- Push-button calibration with auto-buffer recognition for quick and easy calibrations with no mistakes
- Calibration can be performed at 100 % and/or 0 % solution
- Auto-compensation of Salinity and Barometric Pressure with manual input
- Galvanic probe eliminates polarisation delay and delivers quick, stable response
- Non-volatile memory holds meter settings, even when batteries run out
- Hold function freezes readings for easy reference
- Auto-off conserves energy and lengthens battery life-span
- Easy troubleshooting with comprehensive self-diagnostic messages



### Applications

- Ponds and aquariums • Aquaculture (catfish and shrimp farming) • Water and wastewater treatment • Recirculating systems • Industrial process systems
- Water-quality testing • Surface and ground water testing (meet EPA regulations)
- Ecological studies and monitoring • Field, laboratory and education institutions

Models	CyberScan Dual-Display			Eutech Single-Display
	DO 600	DO 300	DO 110	DO 6+

## Dissolved Oxygen Handheld Meters Specifications



Measuring Parameter		Dissolved Oxygen / °C / °F			
Highlights		Waterproof, GLP, RS232C, IrDA	Waterproof, back-lit display	Standard handheld, RS232C	
Dissolved Oxygen	Range	0 to 90.00 mg/L or ppm	0.00 to 19.99 mg/L or ppm		
	Resolution	0.01 mg/L or ppm			
	Accuracy	±0.20 mg/L	±1.5 % full scale		
% Saturation of Oxygen	Range	0 to 600.0 %	0.0 to 199.9 %		
	Resolution	0.1 %			
	Accuracy	±2.0 %	±1.5 % full scale		
Calibration		2-point (0 %, 100 %), 1-point (mg/L)			
Temperature	Range	0.0 to 60.0 °C / 32 to 140 °F	0.0 to 50.0 °C / 32 to 122 °F		
	Resolution	0.1 °C / 0.1 °F			
	Accuracy	±0.3 °C / ±0.5 °F			
Salinity Correction	Range	0.0 to 50.0 ppt			
	Resolution	0.1 ppt			
	Method	Automatic correction after manual input			
Barometric Pressure Correction	Range	450 to 825 mmHg / 59.9 to 109.9 kPa	500 to 1499 mmHg / 66.6 to 199.9 kPa		
	Resolution	0.1 mmHg or 0.1 kPa			
	Method	Automatic correction with in-built sensor	Automatic correction after manual input		
Probe	Type	Galvanic			
Meter Features	Temperature Compensation	ATC / MTC (0.0 to 50.0 °C)			
	GLP	Yes		–	
	Cal-Due Alarm	Yes		–	
	IP67	Yes		–	
	Datalogging	Yes	–	Yes	
	Memory	500 data sets	50 data sets	100 data sets	
	Operating Temperature	0 to 50 °C			
	Average/Stability	Yes (selectable)			
	LCD Display	Dot-matrix LCD with backlight (5.4 x 7.1 cm)	Dual-display LCD with backlight (5.8 x 3.3 cm)	Dual-display LCD (5.8 x 3.3 cm)	Single-display LCD (4.5 x 2.3 cm)
	Auto-Off	2 to 30 mins after last key pressed		20 mins after last key pressed	
	Input	DC phono sockets, 6-pin connector		DC socket, 6-pin connector	BNC, 2.5 mm phono socket
	Output	IrDA, RS232C (via LED) *	–	RS232C	–
	Power	4 x 1.5 V 'AA' alkaline batteries or 9 V DC adapter, 500 mA	4 x 1.5 V 'AAA' alkaline batteries	4 x 1.5 V 'AAA' alkaline batteries or 9 V DC adapter, 200 mA	4 x 1.5 V 'AAA' alkaline batteries
Battery Life	> 200 hrs	> 100 hrs	> 700 hrs		
Dimensions (LxWxH); Weight	Meter	18.3 x 9.5 x 5.7 cm ; 460 g	19 x 10 x 6 cm ; 320 g	18 x 9 x 4 cm ; 220 g	15.7 x 8.5 x 4.2 cm ; 255 g
	Boxed	40 x 33 x 10 cm ; 2680 g	40 x 33 x 10 cm ; 2100 g		36 x 28 x 8 cm ; 1555 g

\* RS232C (LED) interface adapter available as separate accessory (see page 63 for order information)



Dissolved Oxygen Handheld Meters

Item	Order Code	Part No.	Parameters		Electrodes				Accessories								
			Dissolved Oxygen	Temperature	7.6 m Cable DO Electrode (ECDOHANDY8M)	3 m Cable DO Electrode (ECDOHANDYNEW)	3 m Cable DO Electrode (DO6HANDY3M)	0.9 m Cable DO Electrode (DO6HANDY)	CyberComm 600 DAS Software	CyberComm Portable DAS Software	Assembled Membrane Cap Housing	Assembled Membrane Cap Housing (x2)	Refilling Electrolyte	RS232C Cable	Power Adapter	CyberScan Carry Kit, Set With 4 Sample Bottles	Economy Carry Kit, Set With 4 Sample Bottles
DO 600	ECDOWP60042K	01X419503	•	•	•				•		•			•		•	
DO 600	ECDOWP60041K	01X419502	•	•		•			•		•			•		•	
DO 300	ECDOWP30002K	01X262314	•	•	•						•			•		•	
DO 300	ECDOWP30001K	01X262307	•	•		•					•			•		•	
DO 110	ECDO11002K	01X403503	•	•	•					•	•		•	•		•	
DO 110	ECDO11001K	01X403502	•	•			•			•	•		•	•		•	
DO 6+	ECDO602PLUSK	01X370113	•	•				•				•	•				•
DO 6+	ECDO601PLUSK	01X370114	•	•					•				•	•			•

Replacement Electrodes

Used With	Description	Order Code	Part No.
DO 600 / DO 300 / DO 110	Galvanic Dissolved Oxygen electrode, ATC, 7.6 m cable with 1 assembled membrane cap housing, 1 refilling electrolyte & 1 scouring pad	ECDOHANDY8M	01X239606
DO 600 / DO 300 / DO 110	Galvanic Dissolved Oxygen electrode, ATC, 3 m cable with 1 assembled membrane cap housing, 1 refilling electrolyte & 1 scouring pad	ECDOHANDYNEW	01X239601
DO 6+	Galvanic Dissolved Oxygen electrode, ATC, 3 m cable with 2 assembled membrane cap housing, 1 refilling electrolyte & 1 scouring pad	ECDO6HANDY3M	01X233916
DO 6+	Galvanic Dissolved Oxygen electrode, ATC, 0.9 m cable 2 assembled membrane cap housing, 1 refilling electrolyte & 1 scouring pad	DO6HANDY	01X233913

Accessories

Used With	Description	Order Code	Part No.
DO 600	CyberScan DO 600 series carry kit set – plastic carry case, 4 empty sample bottles (60 ml)	ECWP600DRYKIT	01X430203
DO 600	100 / 240 VAC SMPS power adapter, 9 V, 6 W, centre +ve, with US / UK / EUR / Japan plug	01X030132	01X030132
DO 600	RS232C (LED) interface adapter	91100-85	01X344202
DO 600 / DO 300 / DO 110 / DO 6	DO refilling electrolyte (60 ml)	01X211226	01X211226
DO 300 / DO 110	CyberScan neutral carry kit set – plastic carry case, 4 empty sample bottles (60 ml)	ECWPDYKIT	01X266804
DO 300 / DO 110	Carry pouch for CyberScan handheld	ECPOUCH02	56X201400
DO 110	100 / 240 VAC SMPS power adapter, 9 V, 6 W, centre +ve, with US / UK / EUR / Japan plug	60X030130	60X030130
DO 110	RS232C communication cable – 9-pin male to 9-pin female connector, 1 m cable	ECCA02M09F09	30X219503
ECDOHANDYNEW / ECDOHANDY8M	Assembled membrane cap housing	15X241402	15X241402
ECDOHANDYNEW / ECDOHANDY8M	Membranes & o-rings (pack of 5 units)	01X241603	01X241603
ECDOHANDYNEW	Tool for membrane housing	15X241502	15X241502
DO6HANDY / ECDO6HANDY3M	Assembled membrane cap housing	01X241608	01X241608

<< Laboratories



<< Industrial Process Systems



<< Fish Ponds

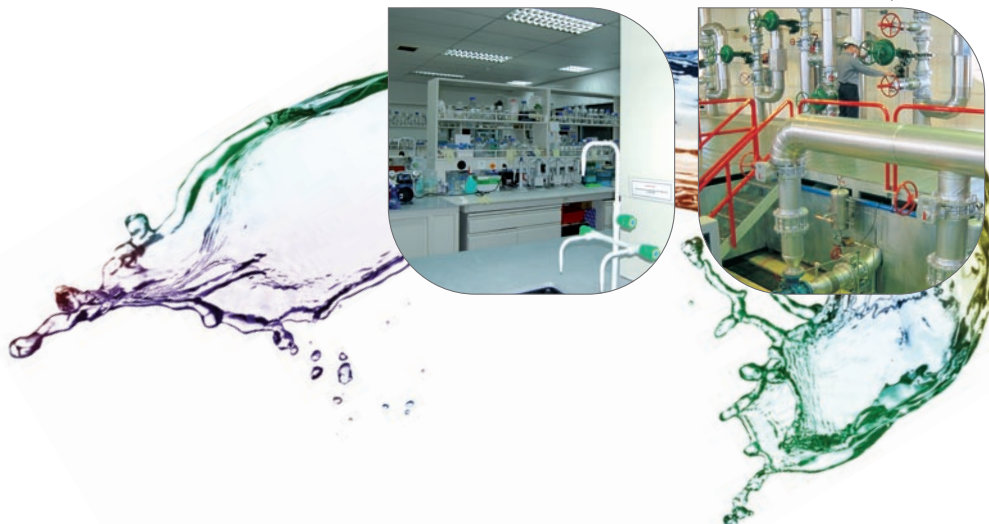

## CyberScan DO 6000

Dissolved Oxygen/BOD/OUR/SOUR/°C/°F

Versatile and user-friendly, the CyberScan DO 6000 is one of the most advanced benchtop meters for dissolved oxygen measurement available. Extensive set-up functions allows you to customise the meter according to specific needs, while extensive communication capabilities give you the flexibility to send your data via any format to anywhere, in any format you want.



OUR, SOUR and auto five day EPA-compliant BOD measurement with self-stirring probe



Plain language prompts and automatic calculation base on BOD parameters entered



Application software with technical controls for 21 CFR Part 11  
(software sold separately)



Multiple communications capabilities

World's first Windows® CE-driven colour touchscreen bench meter



Internet/ethernet-ready connection

USB, IrDA connectivity

Stores up to 1000 data sets per parameter

Durable ABS plastic housing resists chemicals and dust

### Applications

- Pharmaceutical manufacturing • Research and lab course work • Forensic analysis
- Life sciences and medical researches
- Environmental testing labs • Wastewater and drinking water facilities • Food processing and beverage production

- DO measurement includes automatic five-day BOD testing, OUR, and SOUR with sample identity
- Advanced real-time on-screen graphing function provides useful indication for specific measurements
- Extensive setup screens enable you to customise meter to your needs, e.g. Barometer and Salinity setting, BOD/OUR/SOUR configuration, alarm limits and other functions
- Built-in barometer for auto-pressure correction
- Windows® CE-driven, full-color touchscreen provides unmatched ease of use in operations and setups with user-friendly icons, user prompts and context specific 'help' screens
- Secure log-in for up to ten users



1 year warranty for touchscreen display; 3 years warranty for all other meter components.

## DO 2700

Dissolved Oxygen/BOD/°C/°F

Designed for optimal performance and versatility, the DO 2700 come with intuitive, advance set-up options for extensive user-customization at an affordable price! Meter comes with self-stirring probe and bi-directional RS232 – ideal for BOD and other Dissolved Oxygen applications in the laboratory.



Built-in barometer automatically adjusts for most accurate readings



Stability display – faded out and then turns completely black when stable



Non-skid foot pads



Download the latest software from our website  
Coming soon!

- Measures Dissolved Oxygen in % saturation, ppm, mg/L at  $\pm 0.5$  % full scale accuracy
- Automatic calibration at 100 % and independent 0 % – greater measurement sensitivity during low oxygen levels
- Accurate readings in varying conditions with Temperature, Salinity and Barometric Pressure Compensation
- Non-volatile memory holds up to 500 data points – time and date-stamped for GLP compliance
- Bi-directional RS232 for easy data transfer to computer
- Cal-due alarm – no more out-dated calibrations!
- Auto-logging function for convenient continuous monitoring
- Limit alarm alerts when reading falls out of range
- Password protection for setup and calibration



### Applications

- Environmental studies • Wastewater and water treatment • Ecological studies
- Education institution



**DO**  
Economy Bench

## DO 700

Dissolved Oxygen/°C/°F

Economical, user-friendly and accurate, the Eutech DO 700 is your ideal choice for routine applications in laboratories, production plants and schools.



Larger display



Electrode arm can be used on either side



Splashproof keypad



Quick reference guide

### Applications

- Environmental studies • Wastewater and water treatment • Ecological studies
- Education institution

Fast response

Non-skid foot pads



Integrated electrode holder

- Dissolved Oxygen measurements in ppm, mg/L or % saturation
- Accurate readings in varying conditions with Temperature, Salinity and Barometric Pressure Compensation
- Large, comprehensive screen that displays readings, calibration points and electrode indicator
- Ready indicator alerts when readings are stable
- Push button calibration
- Non-volatile memory holds up to 100 data points
- Integral electrode holder

Electrode arm and bracket available as separate accessory (order code: 01X321801) – please refer to page 111



Models	CyberScan Premium Bench	Deluxe Bench	Economy Bench
	DO 6000	DO 2700	DO 700

## Dissolved Oxygen Bench Meters Specifications



Measuring Parameter		Dissolved Oxygen / BOD / OUR / SOUR / °C / °F	Dissolved Oxygen / BOD / °C / °F	Dissolved Oxygen / °C / °F
Highlights		Windows® CE, BOD, OUR and SOUR measurement, color touchscreen LCD	Graphic LCD with backlight & extensive display	Large LCD with dual display
Dissolved Oxygen	Range	0.00 to 60.00 mg/L or ppm (0 to 1272 mbar)	0 to 19.99 mg/L ; 50.0 mg/L	0 to 30 mg/L
	Resolution	0.01 mg/L or ppm (0.1 mbar)	0.01 mg/L ; 0.1 mg/L	0.01 mg/L
	Accuracy	±0.1 + 1 LSD	±0.5 % full scale	
% Saturation of Oxygen	Range	0 to 600 %	0 to 600.0 %	0 to 199.9 % ; 300 %
	Resolution	0.1 %	0.1 %	
	Accuracy	±0.1 % + 1 LSD	±0.5 % full scale	
Temperature	Range	-5.0 to 46.0 °C / 32.0 to 114.8 °F	0.0 to 50.0 °C / 32.0 to 122.0 °F	
	Resolution	0.1 °C / 0.1 °F		
	Accuracy	±0.2 °C / ±0.3 °F	±0.3 °C / ±0.5 °F	±0.5 °C / ±0.9 °F
Salinity Correction	Range	0 to 45 ppt	0 to 50.0 ppt	0 to 50 ppt
	Resolution	0.1 ppt		
Barometric Pressure Correction	Range	450 to 825 mmHg (automatic)		450 to 825 mmHg (manual)
	Resolution	1 mmHg		
	Method	Automatic correction with built-in sensor		Auto correction with manual input
Meter Features	Temperature Compensation	ATC / MTC (0 to 50 °C)		
	GLP	Yes		–
	Datalogging	Yes		
	Memory	Up to 1000 data sets per parameter	500 data sets	100 data sets
	Operating Temperature	5.0 to 45.0 °C / 41.0 to 113.0 °F		
	LCD Display	Windows® CE colour touchscreen (11.43 x 15.24 cm)	Graphic LCD with backlight (5.9 x 7.8 cm)	Custom dual-display LCD (5.6 x 7.5 cm)
	Input	DC socket, DIN, SD card, USB-A, USB-B, RJ45, audio	DC socket, 8-pin connector, RS232	DC socket, BNC, phono (ATC)
	Output	USB, IrDA, RS232C		–
	Power	9 V DC adapter, 3.3 A (100 / 240 VAC, SMPS)	9 V DC adapter, 1.3 A (100 / 240 VAC, SMPS)	
	Dimensions (LxWxH); Weight	Meter	16.5 x 23.5 x 8.9 cm ; 1100 g	17.5 x 15.5 x 6.9 cm ; 650 g
Boxed		49 x 28 x 16 cm ; 3330 g	30.8 x 23.5 x 12.4 cm ; 1800 g	

Dissolved Oxygen



>> Environmental Studies

>> Water Treatment

**Dissolved Oxygen Bench Meters**

Item	Order Code	Part No.	Parameters					Electrodes		Accessories		
			Dissolved Oxygen	BOD	OUR	SOUR	Temperature	Self-Stirring Dissolved Oxygen / BOD Electrode (EC620SSP)	Galvanic Dissolved Oxygen Electrode (DO6HANDY)	CyberComm 6000 DAS Software	RS232C Cable	Power Adapter
DO 6000	ECDO600042C	01X373909	•	•	•	•	•	•		•	•	•
DO 6000	ECDO600042	01X373905	•	•	•	•	•	•				•
DO 2700	ECDO270042	01X543907	•	•			•	•			•	•
DO 700	ECDO70042S	01X543501	•				•		•			•

**Replacement Electrodes**

Used With	Description	Order Code	Part No.
DO 6000 / DO 2700	Dissolved Oxygen / BOD electrode with self-stirring mechanism, 1 m cable	EC620SSP	01X295704
DO 700	Galvanic Dissolved Oxygen electrode, ATC, 0.9 m cable 2 assembled membrane cap housing, 1 refilling electrolyte & 1 scouring pad	DO6HANDY	01X233913

**Accessories**

Used With	Description	Order Code	Part No.
DO 6000	RS232C communication cable – 9-pin male to 9-pin female connector, 1 m cable	ECCA02M09F09	30X219503
DO 6000	6 assembled membrane caps & electrolyte solution (20 ml)	EC637DOM	01X241607
DO 6000	CyberComm 6000 (21 CFR Part 11 compliant CyberScan 6000 series application software)	ECDAS6000	01X415501
DO 6000	100 / 240 VAC SMPS power adapter, 9 V, 3.3 A, centre -ve with 2-pin power cord	60X030128	60X030128
DO 2700	100 / 240 VAC SMPS power adapter, 9 V, 6 W	60X426401	60X426401
DO 700	100 / 240 VAC SMPS power adapter, 9 V, 6 W	60X030130	60X030130
DO 6000	Secure Digital (SD) memory card, 256 MB, Sandisk	01X419901	01X419901

<< Beverage Production



>> Ponds & Aquariums



>> Pharmaceutical Manufacturing

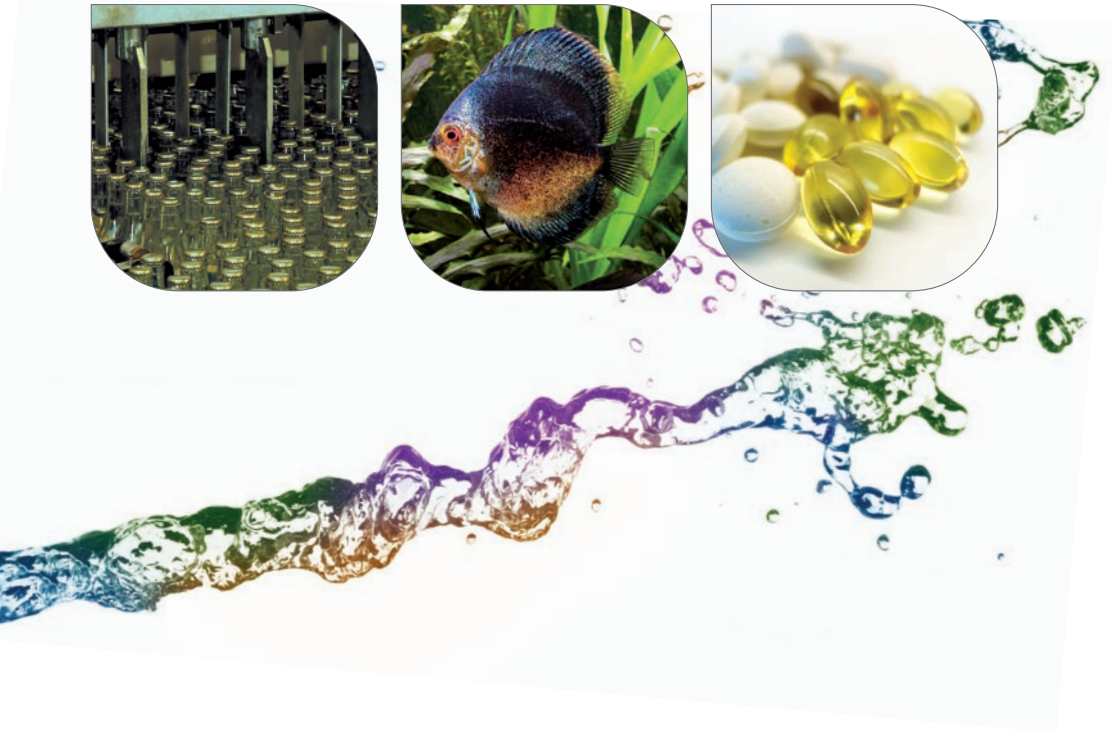



## Multi-Parameter



Do more with less – intelligent instruments that allow you to measure multiple parameters.

**Tester:**

1. PCSTestr™ 35
2. PCTestr™ 35
3. PTTestr™ 35

**Handheld:**

1. CyberScan PCD 650
2. CyberScan PC 650
3. CyberScan PD 650
4. CyberScan CD 650
5. CyberScan PD 300
6. CyberScan PC 300
7. CyberScan PC 10

**Bench:**

1. CyberScan PCD 6500
2. CyberScan PC 6500
3. CyberScan PC 6000
4. PC 2700
5. PC 700

# PCSTestr™ 35 ; PCTestr™ 35 ; PTTestr™ 35

pH/Conductivity/  
TDS/Salinity/°C/°F      pH/Conductivity/°C/°F      pH/TDS/°C/°F

Basic multi-parameter measurements on-the-go is so easy! Eutech's Testr 35 multi-parameter series allows you to measure pH, conductivity, TDS, salinity and temperature with just one handy instrument. Made to fit your pocket – both in size and budget.

**"One-Press"  
Parameter Toggle:  
Multi-Parameter  
Measurement Is  
So Easy!**



**Step 1:** Immerse tester sensor in solution



**Step 2:** Measure and read



**Step 3:** Press "MODE ENT" to toggle to the next parameter



Self-diagnostic with battery indicator

ATC/MTC option

Temperature in °C or °F



User-replaceable pH/Conductivity sensor with ATC

Valox® strong plastic casing offers superior chemical resistance

Chemical resistant Kynar® sensor for longer sensor lifespan

**Applications**

- Pools and spas • Aquariums and fish farms • Agriculture and hydroponics
- Cooling towers • Food processing • Water and wastewater treatment • Photo-development • Printing and chemical industries • Electroplating rinse tanks
- Drinking water • Verification of reverse osmosis system operation • Recirculating system • Labs and ecological studies

- Comes in three multi-parameter models – PCSTestr 35, PCTestr 35 and PTTestr 35 (see spec tables for more details)
- Full pH range measurement at up to 0.01 pH resolution
- Pure, medium and high Conductivity/TDS ranges – tester measures pure water!
- Up to 5-point pH calibration and 3-point Conductivity calibration
- Adjustable TDS factor and Temperature coefficient
- User-friendly and easy to use with menu-driven set-up
- Conserves power with selectable auto-off function



## Multi-Parameter Pocket Testers Specifications



Models	PCSTestr 35	PCTestr 35	PTTestr 35	
Measuring Parameter	pH / Conductivity / TDS / Salinity / °C / °F	pH / Conductivity / °C / °F	pH / TDS / °C / °F	
Highlights	Waterproof, temp. display, 0.01 pH resolution, replaceable sensor	Waterproof, temp. display, 0.1 pH resolution, replaceable sensor		
pH	Range	0.00 to 14.00 pH	0.0 to 14.0 pH	
	Resolution	0.01 pH	0.1 pH	
	Accuracy	±0.01 pH	±0.1 pH	
	Cal. Points	Up to 5 (auto)		
	Auto-Buffer Recognition	Yes		
Conductivity	Range	0.0 to 199.9 µS / 200 to 1999 µS / 2.00 to 20.00 mS	0 to 1999 µS / 2.00 to 20.00 mS	–
	Resolution	0.1 µS / 1 µS / 0.01 mS	1 µS / 0.01 mS	–
	Accuracy	±1 % full scale		–
	Cal. Points	3 auto, 3 manual	2 auto, 2 manual	–
	Temperature Coefficient	0.0 to 10.0 % / °C		–
	Normalisation Temperature	25.0 °C		–
	Auto-Ranging	Yes		–
TDS	Range	0.0 to 99.9 ppm / 100 to 999 ppm / 1.00 to 10.00 ppt	–	0 to 999 ppm / 1.00 to 10.00 ppt
	Resolution	0.1 ppm / 1 ppm / 0.01 ppt	–	1 ppm / 0.01 ppt
	Accuracy	±1 % full scale		±1 % full scale
	Cal. Points	Up to 3 (manual)	–	Up to 2 (manual)
	TDS Factor	0.40 to 1.00	–	0.40 to 1.00
Salinity	Range	0.0 to 99.9 ppm / 100 to 999 ppm / 1.00 to 10.00 ppt / 0.0 to 1.00 %	–	–
	Resolution	0.1 ppm / 1 ppm / 0.01 ppt / 0.01 %	–	–
	Accuracy	±1 % full scale *		–
	Cal. Points	1 (manual, above 1.00 ppt)	–	–
Temperature	Range	0 to 50.0 °C / 32 to 122.0 °F		–
	Resolution	0.1 °C / 0.1 °F		–
	Accuracy	0.5 °C / 0.9 °F		–
Meter Features	Temperature Compensation	ATC / MTC		–
	Sensor Type	pH / Conductivity / TDS / Salinity / Temperature		–
	Non-Volatile Memory	Yes		–
	Auto-Off	8.5 mins after last key pressed (can be disabled)		–
	LCD Display	Dual-display LCD (2.1 x 2.7 cm)		–
	Power	4 x 1.5 V 'A76' micro alkaline batteries		–
Dimensions (LxWxH); Weight	Tester	16.5 x 3.8 cm ; 90 g		–
Boxed	18.5 x 6.5 x 5 cm ; 200 g		–	

\* Applicable from 100 ppm to 10.00 ppt / 0.0 to 1.00 %

### Multi-Parameter Pocket Testers

Item	Order Code	Part No.	Parameters					Sensor	Accessories	
			pH	Conductivity	TDS	Salinity	Temperature	Multi-Parameter Sensor (PCSENSOR)	Lanyard	Alkaline Button Cell Batteries
PCSTestr 35	PCSTEST35	01X441506	•	•	•	•	•	•	•	
PCTestr 35	PCTEST35	01X441504	•	•	•	•	•	•	•	
PTTestr 35	PTTEST35	01X441505	•	•	•	•	•	•	•	

### Replacement Sensors & Electrodes

Used With	Description	Order Code	Part No.
PCSTestr 35 / PTTestr 35 / PCTestr 35	Replacement pH / Conductivity / Temperature sensor	PCSENSOR	01X097108

### Accessories

Used With	Description	Order Code	Part No.
All testrs	Belt-loop soft carrying case for testr	ECPOUCH01	56X201300
All testrs	Alkaline button cell batteries (50 units per pack)	ECBATT14	01X220401



**Multi-Parameter**  
CyberScan Waterproof Handheld



Available in complete kit version



Waterproof external power input



Complimentary Cybercomm 600 software – download data from meter to PC as text or Excel® spreadsheet

Multi-Parameter

## CyberScan PCD 650

pH/ORP/Ion/Conductivity/TDS/Salinity/Resistivity/Dissolved Oxygen/°C/°F

A Eutech Star Buy! Combining the key features of the CyberScan 600 series, Eutech's CyberScan PCD 650 enables concurrent measurement of three parameters in addition to temperature, all of which can be simultaneously displayed on the comprehensive customized LCD screen. With the incorporated IrDA wireless technology, data transfer from meter to computer is a breeze.



IrDA wireless data transfer

**Channel 1:**  
pH, ORP or Ion

**Channel 3:**  
Dissolved Oxygen

**Channel 2:**  
Conductivity, TDS, Resistivity or Salinity

Temperature in °C or °F

Intuitive soft-key operation

Sturdy rubber boot that doubles up as meter stand

### Applications

**Environmental:** Use to test water quality, monitor health of aquatic ecosystems, survey surface and ground water drinking supplies, and meet EPA regulations.

**Water Quality Testing:** For analysing water hard water, drinking water, effluent water, and incoming process water. Ideal for all types of quality assurance and water quality testing.

**Industrial:** For checking metal finishing, cooling tower water, printing fountain solutions, boiler water, brines, rinse tanks, ponds, pollution control, recirculating systems, waste water and industrial process systems. Useful for food analysis and quality assurance testing.

**Aquacultural:** Use to monitor oxygen levels in catfish and shrimp farming; game stocking ponds; ornamental fish tanks and ponds; and in other fish farming applications.

### Wide Measurement Ranges

- Measures accuracy of up to  $\pm 0.002$  pH and resolution of up to 3-decimal points
- Accepts 2-cell and 4-cell Conductivity probe, enabling it to measure a wide Conductivity range of up to 500 mS/cm – meter measures pure water!
- Measures 90.00 mg/L in DO concentration and 600 % in DO saturation – one of the widest Dissolved Oxygen measurement ranges offered in the handheld market today!

### User-Friendly

- Rugged and waterproof for applications in harsh environments
- Step-by-step prompts that guide users through set-up, calibration and trouble-shooting
- High/low set-points function for quality control checks – meter warns when readings fall outside set limit
- Built-in barometer for auto-pressure correction

### Advanced Data-Management

- Meter automatically logs up to 500 readings with time and date in GLP-compliant format
- RS232C through LED\*, IrDA wireless communications technology
- Non-volatile memory protects information and meter settings, even when batteries run out
- Password protection to prevent tampering

\* RS232C (LED) interface adapter available as separate accessory (order code: 01X344201)



## CyberScan PC 650 ; CyberScan PD 650 ; CyberScan CD 650

pH/ORP/Ion/Conductivity/  
TDS/Salinity/Resistivity/°C/°F

pH/ORP/Ion/  
Dissolved Oxygen/°C/°F

Conductivity/TDS/Salinity/  
Resistivity/Dissolved Oxygen/°C/°F

Collecting multi-parameter data in the field is a breeze with Eutech's CyberScan 650 handheld series. PC 650, PD 650 and CD 650 delivers quick, lab-accurate measurements of pH, ORP, Ion, Conductivity, TDS, Resistivity, Salinity, Dissolved Oxygen and/or Temperature simultaneously. Comprehensive dual-channel display allows you to view two parameters at the same time, along with electrode data and calibration information – all of which can be easily transferred from meter to computer via the incorporated wireless IrDA port.



Real-time clock

**Channel 1:**  
pH, ORP or Ion

**Channel 2:**  
Conductivity,  
TDS, Resistivity  
or Salinity

Temperature  
in °C or °F



PD 650 screen

**Channel 1:**  
pH, ORP or Ion

**Channel 2:**  
Dissolved Oxygen



CD 650 screen

**Channel 1:**  
Conductivity,  
TDS, Resistivity  
or Salinity

**Channel 2:**  
Dissolved Oxygen  
in mg/L or  
% saturation

IP67 waterproof



Wireless data transfer



Sturdy rubber boot  
doubles up as meter stand



Velcro strap  
for firmer grip

Multi-Parameter

### Wide Measurement Ranges

- Measures accuracy of up to  $\pm 0.02$  pH and resolution of up to 3-decimal points (PC 650 and PD 650)
- Features a wide conductivity measurement range of up to 500 mS – meter measures pure water! (PC 650 and CD 650)
- Offers one of the widest dissolved oxygen measurement ranges available in the handheld market today (PD 650 and CD 650)

### User-Friendly

- Rugged and waterproof for applications in harsh environments
- Step-by-step prompts that guide users through set-up, calibration and trouble-shooting

### Advanced Data-Management

- Meter automatically locks in up to 500 readings with time and date in GLP-compliant format
- Wireless information transfer from meter to computer
- Non-volatile memory protects information and meter settings, even when batteries run out
- Four levels of password protection to prevent tampering



### Applications

**Environmental:** Use to test water quality, monitor health of aquatic ecosystems, survey surface and ground water drinking supplies, and meet EPA regulations.

**Water Quality Testing:** For analysing water hard water, drinking water, effluent water, and incoming process water. Ideal for all types of quality assurance and water quality testing.

**Industrial:** For checking metal finishing, cooling tower water, printing fountain solutions, boiler water, brines, rinse tanks, ponds, pollution control, recirculating systems, waste water and industrial process systems. Useful for food analysis and quality assurance testing.

**Aquacultural:** Use to monitor oxygen levels in catfish and shrimp farming; game stocking ponds; ornamental fish tanks and ponds; and in other fish farming applications.

## CyberScan PD 300

pH/Dissolved Oxygen/°C/°F

Toggle between DO (% sat or mg/L) and pH with a simple keypress. No waiting time is required with the galvanic probe that delivers quick, stable response. With adjustable backlit large dual-display LCD for optimised view, this multi-parameter meter is ideal for outdoor field measurement in dim surroundings.



Custom dual-  
display LCD  
with backlight

IP67  
waterproof

Submersible  
pH electrode

Galvanic probes  
require no  
warm-up time

### Applications

**Industrial:** Ideal for checking quality of plant water intake and discharge, wastewater and water treatment, recirculating systems and industrial process systems. Ideal for pH checks in water conditioning plants, cooling towers, plating and finishing operations, and chemical process verification.

**Aquacultural:** Use to monitor oxygen levels in catfish and shrimp farming; game stocking ponds; ornamental fish tanks and ponds; and in other fish farming applications.

**Environmental:** Use to test water quality, monitor health of aquatic ecosystems, survey surface and ground water drinking supplies, and to meet EPA regulations.

**Educational:** Ideal for quick, accurate DO readings in laboratories and schools.

- Multi-parameter PD 300 measures pH, Dissolved Oxygen and Temperature
- Up to 5-point pH push button calibration
- 2-point calibration for Dissolved Oxygen measurement
- Advanced setup mode possible
- Rugged carry-all meter kits available





## CyberScan PC 300 ; CyberScan PC 10

pH/Conductivity/TDS/°C/°F

pH/Conductivity/°C

pH, conductivity and temperature measurements all conveniently packed into one handheld meter – the CyberScan PC 300 features easy interchangeability of specialty electrodes for specific applications; CyberScan PC 10 comes with a combined multi-sensor submersible probe: no need to change probes to measure different parameters!

User-customisation for enhanced flexibility and viewing of meter information

PC 300

PC 10

Multi-sensor submersible probe



Available in complete kit version

- Toggles between pH/Temperature and Conductivity/Temperature with the touch of a button. PC 300 also measures TDS
- Waterproof to IP67 standard – meter floats for easy retrieval!
- Multi-point push-button calibration
- Auto-buffer recognition for pH calibration
- Auto-ranging for Conductivity measurements
- Meter prompts when reading has stabilised
- Large, easy to read LCD screen



### Applications

**Industrial:** For checking metal finishing, cooling tower water, printing fountain solutions, boiler water, brines, rinse tanks, ponds, pollution control, recirculating systems, waste water and industrial process systems. Useful for food analysis and quality assurance testing.

**Water Quality Testing:** For analysing water hard water, drinking water, effluent water, and incoming process water. Ideal for all types of quality assurance and water quality testing.

**Environmental/Agricultural:** For ecology studies, aquaculture and hydroponics.

**Educational:** Ideal for quick pH and Conductivity checks in laboratories and schools.

**Multi-Parameter**  
Handheld Meters Specifications

Models	PCD 650	PC 650	PD 650	CD 650	PD 300	PC 300	PC 10
--------	---------	--------	--------	--------	--------	--------	-------

**Multi-Parameter Handheld Meters Specifications**



Measuring Parameter	pH / ORP / Ion / Conductivity / TDS / Salinity / Resistivity / Dissolved Oxygen / °C / °F	pH / ORP / Ion / Conductivity / TDS / Salinity / Resistivity / °C / °F	pH / ORP / Ion / Dissolved Oxygen / °C / °F	Conductivity / TDS / Salinity / Resistivity / Dissolved Oxygen / °C / °F	pH / Dissolved Oxygen / °C / °F	pH / Conductivity / TDS / °C / °F	pH / Conductivity / °C	
Highlights	Waterproof, GLP, RS232C, IrDA, multi-parameter display				Waterproof with back lighting	Waterproof, speciality probe compatible	Waterproof, combined multi-submersible probe	
pH	Range	-2.000 to 20.000 pH	-	-	-2.00 to 16.00 pH	0.01 pH	0.00 to 14.00 pH	
	Resolution	0.1 / 0.01 / 0.001 pH	-	-	±0.01 pH	-	-	
	Accuracy	±0.002 pH	-	-	-	-	-	
	Cal. Points	1 (offset) to 6-points	-	-	5	3	-	
	Auto-Buffer Recognition	Yes	-	-	Yes	-	-	
	Slope & Offset Display	Yes	-	-	Yes	-	-	
Ion	Range	0.001 to 19900	-	-	-	-	-	
	Resolution	2 or 3 digits	-	-	-	-	-	
	Accuracy	0.5 % full scale (monovalent) ; 1 % full scale (divalent)	-	-	-	-	-	
	Cal. Points	Up to 8	-	-	-	-	-	
ORP	Range	±2000.0 mV	-	-	-	-	-	
	Resolution	0.1 mV	-	-	-	-	-	
	Accuracy	±0.2 mV	-	-	-	-	-	
Temperature	Range	-10.0 to 110.0 °C / 14.0 to 230.0 °F (meter) 0 to 60.0 °C / 32 to 140 °F (for DO)	-10.0 to 110.0 °C / 14.0 to 230.0 °F (meter)	-10.0 to 110.0 °C / 14.0 to 230.0 °F (meter) 0 to 60.0 °C / 32 to 140 °F (for DO)	-10.0 to 110.0 °C / 14.0 to 230.0 °F (meter)	0.0 to 80.0 °C (with supplied probe)	-	
	Resolution	0.1 °C / 0.1 °F					0.1 °C	-
	Accuracy	±0.5 °C / ±0.9 °F				0.3 °C	±0.5 °C / ±0.9 °F	±0.5 °C
Conductivity	Range	.. to 2,000 µS 2,000 to 300.0 µS 300.0 µS to 4,000 mS 4,000 to 40.00 mS 40.00 to 500.0 mS	-	.. to 2,000 µS 2,000 to 300.0 µS 300.0 µS to 4,000 mS 4,000 to 40.00 mS 40.00 to 500.0 mS	-	.. to 1999 / 199.9 / 1999 µS ; .. to 19.99 / 199.9 mS	.. to 1999 / 199.9 / 1999 µS ; .. to 19.99 mS	
	Resolution	0.01µS / 0.1 µS / 0.001mS / 0.01mS / 0.1 mS	-	0.01µS / 0.1µS / 0.001mS / 0.01mS / 0.1 mS	-	0.01 / 0.1 / 1 µS ; 0.01 / 0.1 mS	0.01 / 0.1 / 1 µS ; 0.01 mS	
	Accuracy	±1 % full scale + 1 LSD	-	±1 % full scale + 1 LSD	-	±1 % full scale + 1 LSD	±1 % full scale + 1 LSD	
	Cal. Points	4 (1 per range) auto, 5 (1 per range) manual	-	4 (1 per range) auto, 5 (1 per range) manual	-	5 (1 per range) manual	4 (1 per range) manual	
	Cell Constant (K)	0.010 to 10.000	-	0.010 to 10.000	-	1.0	1.0	
	Temperature Coefficient	Linear & pure	-	Linear & pure	-	0.0 to 10.0 % (adjustable)	2.00 %	
	Normalisation Temperature	15 to 30 °C	-	15 to 30 °C	-	15.0 to 30.0 °C (adjustable)	25 °C	
	Auto-Ranging	Yes	-	Yes	-	Yes	Yes	
TDS	Range (Depending On TDS Factor)	.. to 2,000 ppm 2,000 ppm to 300.0 ppt 300.0 ppt to 4,000 ppt 4,000 ppt to 40.00 ppt 40.00 ppt to 500.0 ppt	-	.. to 2,000 ppm 2,000 ppm to 300.0 ppt 300.0 ppt to 4,000 ppt 4,000 ppt to 40.00 ppt 40.00 ppt to 500.0 ppt	-	.. to 999/999/999 ppm ; .. to 9.99 / 99.9 ppt ; Max of 199.9 ppt based on factor setting	-	
	Resolution	0.01 ppm / 0.1 ppm / 0.001 ppt / 0.01 ppt / 0.1 ppt	-	0.01 ppm / 0.1 ppm / 0.001 ppt / 0.01 ppt / 0.1 ppt	-	0.01 / 0.1 / 1 ppm ; 0.01 / 0.1 ppt	-	
	Accuracy	±1 % full scale + 1 LSD	-	±1 % full scale + 1 LSD	-	±1 % full scale + 1 LSD	-	
	Conversion Factor	0.40 to 1.0	-	0.40 to 1.0	-	0.40 to 1.0	-	

[Continued on page 77]

[Continued from page 76]

## Multi-Parameter Handheld Meters Specifications



Models	PC D 50	PC 650	PD 650	CD 650	PD 300	PC 300	PC 10	
Salinity	Range	.. to 0.770 ppm 0.770 ppm to 143.3 ppm 143.3 ppm to 2.138 ppt 2.138 ppt to 23.64 ppt 23.64 ppt to 80.00 ppt	–	–	.. to 0.770 ppm 0.770 ppm to 143.3 ppm 143.3 ppm to 2.138 ppt 2.138 ppt to 23.64 ppt 23.64 ppt to 80.00 ppt	–	–	
	Resolution	0.01 ppm / 0.1 ppm / 0.001 ppt / 0.01 ppt	–	–	0.01 ppm / 0.1 ppm / 0.001 ppt / 0.01 ppt	–	–	
	Accuracy	±1 % full scale + 1 LSD	–	–	±1 % full scale + 1 LSD	–	–	
Resistivity	Range	2.000 Ω to 25.00 Ω 25.00 Ω to 250.0 Ω 250.0 Ω to 3.333 kΩ 3.333 kΩ to 500.0 kΩ 500.0 kΩ to 20.00 MΩ	–	–	2.000 Ω to 25.00 Ω 25.00 Ω to 250.0 Ω 250.0 Ω to 3.333 kΩ 3.333 kΩ to 500.0 kΩ 500.0 kΩ to 20.00 MΩ	–	–	
	Resolution	0.01 Ω / 0.1 Ω / 0.001 Ω / 0.1 Ω / 0.01 MΩ	–	–	0.01 Ω / 0.1 Ω / 0.001 Ω / 0.1 Ω / 0.01 MΩ	–	–	
	Accuracy	1 % full scale	–	–	1 % full scale	–	–	
Dissolved Oxygen	Range	0.00 to 90.00 mg/L or ppm	–	0.00 to 90.00 mg/L or ppm	0.00 to 20.00 mg/L or ppm	–	–	
	Resolution	0.01 mg/L; 0.01 ppm	–	0.01 mg/L; 0.01 ppm	–	–	–	
	Accuracy	±0.2 mg/L	–	±0.2 mg/L	±1.5 % full scale	–	–	
	Cal. Points	1	–	1	–	–	–	
% Saturation of Oxygen	Range	0 to 600.0 %	–	0 to 600.0 %	0.0 to 200.0 %	–	–	
	Resolution	0.1 %	–	0.1 %	0.1 %	–	–	
	Accuracy	±2.0 %	–	±2.0 %	±1.5 % full scale	–	–	
Salinity Correction	Range	0.0 to 50.0 ppt	–	0.0 to 50.0 ppt	0.0 to 50.0 ppt	–	–	
	Resolution	0.1 ppt	–	0.1 ppt	–	–	–	
	Method	Automatic / manual	–	Automatic correction after manual input	Automatic / manual	Automatic correction after manual input	–	
Barometric Pressure Correction	Range	450 to 825 mmHg or 59.9 to 109.9 kPa	–	450 to 825 mmHg or 59.9 to 109.9 kPa	500 to 1499 mmHg or 66.6 to 199.9 kPa	–	–	
	Resolution	0.1 mmHg or 0.1 kPa	–	0.1 mmHg or 0.1 kPa	–	–	–	
	Method	Automatic correction with built-in sensor	–	Automatic correction with built-in sensor	Automatic correction after manual input	–	–	
Meter Features	Temperature Compensation	ATC / MTC (0 to 100 °C)						
	GLP	Yes			–			
	Cal-Due Alarm	Yes			–			
	IP67	Yes						
	Datalogging	Yes			–			
	Memory	500 data sets			50 data sets		–	
	Operating Temperature	0 to 50 °C						
	Ready Function	Yes						
	Hold Function	Yes						
	LCD Display	Dot-matrix LCD with backlight (5.4 x 7.1 cm)				Dual-display LCD with backlight (5.8 x 3.3 cm)	Dual-display LCD (5.8 x 3.3 cm)	
	Auto-Off	2 to 30 mins after last key pressed				20 mins after last key pressed		
	Input	DC phono sockets, BNC, 8-pin connector, 6-pin connector	DC phono sockets, BNC, 8-pin connector	DC phono sockets, BNC, 8-pin connector, 6-pin connector	DC phono sockets, BNC, 8-pin connector	BNC, 6-pin connector		6-pin connector
	Output	IrDA, RS232C (via LED) *						
Power	4 x 1.5 V 'AA' alkaline batteries or 9V DC adapter, 500 mA				4 x 1.5 V 'AAA' alkaline batteries			
Battery Life	> 200 hrs		> 400 hrs	> 200 hrs	> 100 hrs		> 50 hrs	
Dimensions (LxWxH); Weight	Meter Boxed 18.3 x 9.5 x 5.7 cm; 460 g			19 x 10 x 6 cm; 700 g		19 x 10 x 6 cm; 320 g		
	40 x 33 x 10 cm; 3200 g			40 x 33 x 10 cm; 2180 g				

\* RS232C (LED) interface adapter available as separate accessory (see page 78 for order information)



## Multi-Parameter

### Handheld Meters Ordering Information

#### Multi-Parameter Handheld Meters – CyberScan 600 Series

Item	Order Code	Part No.	Parameters									Electrodes				Accessories			
			pH	ORP	Ion	Conductivity	TDS	Salinity	Resistivity	Dissolved Oxygen	Temperature	pH Electrode (ECFC7252203B)	4-Cell Conductivity Probe (CONSEN9203J)	Dissolved Oxygen Probe (ECDOHANDYNEW)	ATC Probe (PHWPTEM03J)	CyberComm 600 DAS Software	Multi-Probe Holder	Power Adapter	CyberScan Carry Kit Set With Calibration Stds
PCD 650	ECPCDWP65044K	01X430902	•	•	•	•	•	•	•	•	•	•	•	•	•	•	•	•	•
PC 650	ECPCWP65043K	01X430602	•	•	•	•	•	•	•	•	•	•	•	•	•	•	•	•	•
PD 650	ECPDWP65043K	01X430702	•	•	•	•	•	•	•	•	•	•	•	•	•	•	•	•	•
CD 650	ECCDWP65043K	01X430802	•	•	•	•	•	•	•	•	•	•	•	•	•	•	•	•	•

#### Multi-Parameter Handheld Meters – CyberScan 300 Series & 10 Series

Item	Order Code	Part No.	Parameters									Electrodes				Accessories			
			pH	ORP	Ion	Conductivity	TDS	Salinity	Resistivity	Dissolved Oxygen	Temperature	pH Electrode (ECDA9350603B)	pH Electrode (ECFC7252201B)	2-Cell Conductivity Probe (CONSEN91W)	Dissolved Oxygen Probe (ECDOHANDYNEW)	pH / Cond Combination Probe (ECCOMB03M)	Electrode Holder (x2)	Assembled Membrane Cap Housing	Refilling Electrolyte
PD 300	ECPDWP30003K	01X267001	•								•	•	•	•			•	•	•
PC 300	ECPCWP30003K	01X262901	•			•	•				•	•	•			•			•
PC 10	ECPCWP1003K	01X268701	•			•					•	•	•	•					•

#### Replacement Electrodes

Used With	Description	Order Code	Part No.
PCD 650 / PD 650 / CD 650 / PD 300	Galvanic Dissolved Oxygen electrode, ATC, 10 ft cable with assembled membrane cap housing, refilling electrolyte and scouring pad	ECDOHANDYNEW	01X239601
PCD 650 / PC 650 / PD 650	General purpose plastic-body double junction gel-filled pH combination electrode, 12 x 90 mm, BNC connector, 3 m cable	ECFC7252203B	01X417010
PCD 650 / PC 650 / PD 650	ATC probe, 3 m cable	PHWPTEM03J	01X021820
PCD 650 / PC 650 / CD 650	4-cell epoxy-body Conductivity electrode with ATC, cell constant K=1.0, 12 x 120 mm, 8-pin connector, 3 m cable	CONSEN9203J	01X238761
PC 300	General purpose plastic-body double junction gel-filled pH combination electrode, 12 x 90 mm, BNC connector, 1 m cable	ECFC7252201B	01X099417
PC 300	2 stainless steel rings ultem-body Conductivity electrode with ATC, cell constant K=1.0, 16 x 144 mm, 6-pin connector, 1 m cable	CONSEN91W	01X244702
PD 300	Submersible gel-filled pH combination electrode with 15 cm ABS guard; single annular ceramic junction, 3 m cable	ECDA9350603B	93X218879
PC 10	Combined pH combination electrode and 2-pin stainless steel Conductivity electrode with ATC, 15 cm ABS guard, 3 m cable	ECCOMB03M	01X234601

#### Accessories

Used With	Description	Order Code	Part No.
PCD 650 / PC 650 / PD 650 / CD 650	100 / 240 VAC SMPS power adapter, 9 V, 6 W, centre +ve power adapter with US / UK / EUR / Japan plug	01X030132	01X030132
PCD 650 / PC 650 / PD 650 / CD 650	RS232C (LED) interface adapter	91100-85	01X344202
PCD 650 / PC 650	pH / Conductivity kit set – plastic carry case, buffer solutions (pH 4.01, pH 7.00), KCl standard solution (12.88 mS), deionised (rinse) water	ECPCWP650KIT	01X430205
PD 300	CyberScan pH carry kit set – plastic carry case, buffer solutions (pH 4.01, pH 7.00), storage solution, deionised (rinse) water	ECPHWPKIT	01X266801
PD 300	Assembled membrane cap housing	15X241402	15X241402
PD 300	DO refilling electrolyte (60 ml)	01X211226	01X211226
PD 300	Membranes & o-rings (pack of 5 units)	01X241603	01X241603
PC 10 / PC 300	pH / Conductivity kit set – plastic carry case, buffer solutions (pH 4.01, pH 7.00), KCl standard solutions (1413 uS, 12.88 mS)	ECPCWPKIT	01X266803
12 mm diameter electrode	Electrode holder	15X000700	15X000700
16 mm diameter electrode	Electrode holder	15X000702	15X000702

# CyberScan PCD 6500

pH/ORP/Ion/Conductivity/TDS/Salinity/Resistivity/Dissolved Oxygen/BOD/OUR/SOUR/°C/°F

Top-of-the-line, research-grade CyberScan PCD 6500 touchscreen meter measures and displays up to four channels at one time. With up to ten measurement parameters to choose from, the PCD 6500 features advanced design that prevents cross talk or other interferences. Plus, automatic five day BOD testing with sample identity, as well as comprehensive communications capabilities that allows you to send your data to any computer in the world via internet – directly from the meter!

World's first Windows® CE-driven colour touchscreen bench meter

An industry pioneer!  
Four channel display



Real-time on-screen graphing capabilities

Stores up to 1000 data sets per parameter



OUR, SOUR and auto five day EPA-compliant BOD measurement with self-stirring probe



Direct printing of data during measurement



Secure log-in for up to ten users



Application software with technical controls for 21 CFR Part 11 (software sold separately)

- Up to four channels measured and displayed simultaneously without cross channel interference
- Wide pH and ORP measurement range: -2.000 to 20.000 pH and  $\pm 2000.0$  mV
- 'Direct/indirect', 'known addition/subtraction' and 'analate addition/subtraction' Ion measurement methods in ppm, %, mg/mL and mole/L
- Built-in replatinising circuit – replatinisation procedure in less than 5 minutes!
- DO measurement includes five-day BOD testing, OUR, and SOUR and simple DO measurements
- Single-point and multi-point standardization for Conductivity, Resistivity, TDS and Salinity measurements using 2-cell and 4-cell probes
- Secure log-in for up to ten users



1 year warranty for touchscreen display; 3 years warranty for all other meter components.

## Applications

- Pharmaceutical manufacturing • Research and lab course work • Forensic analysis
- Life sciences and medical researches
- Environmental testing labs • Wastewater and drinking water facilities • Food processing and beverage production

## CyberScan PC 6500 ; CyberScan PC 6000

pH/ORP/Ion/Conductivity/TDS/  
Salinity/Resistivity/°C/°F

pH/ORP/Conductivity/TDS/Salinity/  
Resistivity/°C/°F

Simplify lab work with the multi-channel capabilities of the Eutech CyberScan PC 6500. Advanced design ensures no cross-talks during multi-parameter measurements. Built-in replatinising circuit allows a quick, replatinisation procedure in no more than five minutes, while extensive communications capabilities allows you to send your information to any computer in any format you want – using a USB port, wirelessly via the IrDA, through a local server via LAN connection or over the internet to any computer in the world!



Multiple communications capabilities



Single point and multi-point standardization for Conductivity, Resistivity, TDS and Salinity measurements



Application software with technical controls for 21 CFR Part 11  
*(software sold separately)*

World's first Windows® CE-driven colour touchscreen bench meter

Internet/ethernet-ready connection for direct on-line access

Effortless navigation with familiar Windows® user-interface



View and display three channels simultaneously without cross channel interference

Stores up to 1000 data sets per parameter

### Applications

- Pharmaceutical manufacturing
- Research and lab course work
- Forensic analysis
- Life sciences and medical researches
- Environmental testing labs
- Wastewater and drinking water facilities
- Food processing and beverage production

- Simultaneous measurement and display of up to three channels (two channels for PC6000) with no cross channel interferences
- Wide pH and ORP measurement range: -2.000 to 20.000 pH and ± 2000.0 mV
- 'Direct/indirect', 'known addition/subtraction' and 'analate addition/subtraction' Ion measurement methods in ppm, %, mg/mL and mole/L
- Advanced real-time on-screen graphing function provides useful indication for specific measurements such as titration
- Extensive setup screens enables you to customise meter to your needs, e.g. cell constant, temperature coefficient, TDS factor, alarm limits and other functions
- Secure log-in for up to ten users



1 year warranty for touchscreen display; 3 years warranty for all other meter components.



## PC 2700

pH/ORP/Conductivity/TDS/Salinity/Resistivity/°C/°F

Your all-in-one solution for multi-parameter research work in the lab! The new PC 700 is accurate, reliable and intuitive with user-friendly functions. Meter comes with a multi-data screen that includes Temperature, electrode status, calibration points, date and time along with your desired measurement parameter. PC 2700 measures pH, ORP, Conductivity, TDS, Salinity, or Resistivity!

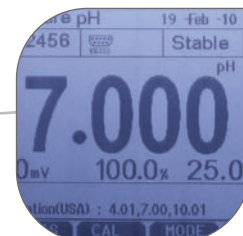

Stability display – faded out and then turns completely black when stable



Bright blue backlight/illuminated display



Download the latest software from our website  
Coming soon!

- Choose auto-calibration with preset values for quick easy calibration, or manual multi-point calibration for greater accuracy
- Easy standardization with auto-standardization feature – detect the exact cell constant value of your electrodes with the press of a button
- Up to 6-point calibration with auto-buffer recognition
- Includes high performance 4-cell Conductivity probe
- Quick, easy electrode diagnosis with the effective cell constants display
- Non-volatile memory holds up to 500 data points – time and date-stamped for GLP compliance
- Bi-directional RS232 for easy data transfer to computer
- Cal-due alarm – no more out-dated calibrations!
- Auto-logging function for convenient continuous monitoring
- Limit alarm alerts when reading falls out of range
- Password protection for setup and calibration

Electrode arm and bracket available as separate accessory (order code: 01X321801) – please refer to page 111



### Applications

- Water quality testing • Checking metal finishes • Solutions • Cooling tower water
- Printing fountain solutions • Boiler water • Brines • Drilling mud • Rinse tanks • Ponds
- Pollution control • Recirculating systems • Waste water • Industrial process systems
- General use in laboratories • Titration • Quality assurance • Ecological studies
- Food-processing

**Multi-Parameter**  
Economy Bench

**PC 700**

pH/ORP/Conductivity/TDS/°C/°F

The multi-parameter Eutech PC 700 measures pH, ORP, conductivity and temperature with a single meter. User-friendly with advanced features and a large custom-size display – perfect for research work on a budget!



Larger display



Electrode arm can be used on either side



Splashproof keypad



Non-skid foot pads



Integrated electrode holder

Fast response

Quick reference guide

**Applications**

- Water quality testing • Checking metal finishes • Solutions • Cooling tower water
- Printing fountain solutions • Boiler water • Brines • Drilling mud • Rinse tanks • Ponds
- Pollution control • Recirculating systems • Waste water • Industrial process systems
- General use in laboratories • Titration • Quality assurance • Ecological studies
- Food-processing

- Large, comprehensive screen that displays readings, calibration points and electrode indicator
- Ready indicator alerts when readings are stable
- Up to 5-point push button calibration
- Auto-ranging across 5 conductivity ranges
- Non-volatile memory holds up to 100 data points
- Integral electrode holder

\* Electrode arm and bracket available as separate accessory (order code: 01X321801) – please refer to page 111



## Multi-Parameter Bench Meters Specifications



Models	CyberScan Premium Bench			Deluxe Bench	Economy Bench	
	PCD 6500	PC 6500	PC 6000	PC 2700	PC 700	
Measuring Parameter	pH / pH FET / ORP / Ion / Conductivity / TDS / Salinity / Resistivity / Dissolved Oxygen / BOD / OUR / SOUR / °C / °F			pH / ORP / Ion / Conductivity / TDS / Salinity / Resistivity / °C / °F	pH / ORP / Conductivity / TDS / Resistivity / °C / °F	
Highlights	Windows® CE, 4 channel color touchscreen		Windows® CE, 3 channel color touchscreen	Windows® CE, 2 channel color touchscreen	Graphic LCD with backlight & extensive display	Large LCD with dual display
pH	Range	-2.000 to 20.000 pH			-2.000 to 20.000 pH	0.00 to 14.00 pH
	Resolution	0.1 / 0.01 / 0.001 pH				0.01 pH
	Accuracy	±0.1 / 0.01 / 0.002 pH + 1 LSD			±0.002 pH	±0.01 pH + 1 LSD
	Cal. Points	Up to 5			Up to 6	Up to 5
Ion	Concentration	1 x 10 <sup>-7</sup> to 9.99 x 10 <sup>10</sup> ppm		0.001 to 19999	-	
	Resolution	4 significant figures		2 or 3 digits	-	
	Accuracy	±0.17 n %		0.5 % full scale (monovalent) ; 1 % full scale (divalent)	-	
	Cal. Points	Up to 5		8	-	
Temperature	Range (Meter)	-5.0 to 105.0 °C / 23.0 to 221.0 °F (DO temp range: 0.0 to 50.0 °C / 32.0 to 122.0 °F)			0.0 to 100.0 °C / 32.0 to 212.0 °F	
	Resolution	0.1 °C / 0.1 °F				
	Accuracy	±0.2 °C / ±0.3 °F			±0.3 °C / ±0.5 °F	±0.5 °C / ±0.9 °F
ORP	Range	±2000.0 mV				±2000 mV
	Resolution	0.1 mV				0.1 mV (±199.9 mV) ; 1 mV (beyond)
	Accuracy	±0.2 mV				±0.2 mV (±199.9 mV) ; ±2 mV (beyond)
Conductivity	Range	.. to 200 µS 200.0 µS to 2.000 mS 2.000 to 20.00 mS 20.00 to 500.0 mS		0.050 µS to 500.0 mS	0.0 µS to 200.0 mS	
	Resolution	0.001 / 0.01 / 0.1 µS ; 0.001 / 0.01 / 0.1 mS		0.01 / 0.1 µS ; 0.001 / 0.01 / 0.1 mS	0.01 / 0.1 µS ; 0.01 / 0.1 mS	
	Accuracy	0.5 % full scale + 1 LSD		±1 % full scale	±1 % full scale	
TDS	Range	.. to 200.0 ppm 200.0 to 2000 ppm 2.000 to 20.00 ppt 20.00 to 500.0 ppt**		0.050 mg/L to 500.0 g/L	.. to 100.0 ppt @ 0.5 fact (200.0 @ 1 factor)	
	Resolution	0.001 / 0.01 / 0.1 ppm ; 0.001 / 0.01 / 0.1 ppt		0.01 / 0.1 ppm ; 0.001 / 0.01 / 0.1 ppt	0.01 / 0.1 / 1 ppm ; 0.01 / 0.1 ppt	
	Accuracy	0.5 % full scale + 1 LSD		±1 % full scale	±1 % full scale	
Salinity	Range	.. to 0.094 ppt 0.094 to 1.000 ppt 1.0 to 11.50 ppt 11.50 to 90.00 ppt		0.0 to 80.0 ppt	-	
	Resolution	0.1 / 0.01 / 0.001 ppt		0.1 ppt	-	
	Accuracy	0.5 % full scale + 1 LSD		±1 % full scale	-	
Resistivity	Range	0 to 100.0 mΩ over 4 ranges		2.000 Ω to 20.0 mΩ	-	
	Resolution	0.1 / 0.01 / 0.001 kΩ ; 0.1 / 0.01 mΩ		0.01 / 0.1 Ω ; 0.001 / 0.1 kΩ ; 0.01 mΩ	-	
	Accuracy	0.5 % full scale + 1 LSD		±1 % full scale	-	
Dissolved Oxygen (BOD, OUR, SOUR)	Range	0 to 60 mg/L ; 0 to 600 % saturation (0 to 1272 mbar)		-	-	
	Resolution	0.01 mg/L ; 0.1 % saturation (0.1 mbar)		-	-	
	Accuracy	0.1 mg/L + 1 digit ; 0.1 % + 1 LSD		-	-	
Meter Features	Temperature Compensation	pH: ATC / MTC (-5 to 105 °C) ; Cond: ATC / MTC (-5 to 100 °C) ; DO: ATC (-5 to 46 °C)			ATC / MTC	
	GLP	Yes			-	
	Datalogging	Yes			-	
	Memory	Up to 1000 data sets per parameter			500 data sets	100 data sets
	Operating Temp.	5 to 45 °C			0 to 50 °C / 32 to 122 °F	
	LCD Display	Windows® CE colour touchscreen (11.43 x 15.24 cm)			Graphic LCD with backlight (5.9 x 7.8 cm)	Custom dual-display LCD (5.6 x 7.5 cm)
	Input	DC socket, 2 DIN, 2 BNC, 2 phono (ATC), FET, SD card, USB-A, USB-B, RJ45, audio	DC socket, DIN, 2 BNC, 2 phono (ATC), FET, SD card, USB-A, USB-B, RJ45, audio	DC socket, DIN, BNC, phono (ATC), FET, SD card, USB-A, USB-B, RJ45, audio	DC socket, BNC, 8-pin DIN (2-cell or 4-cell), RS232	DC socket, BNC, 8-pin DIN (2-cell)
	Output	USB, IrDA, RS232C			RS232	-
Power	9 V DC adapter, 3.3 A (100 / 240 VAC, SMPS)			9 V DC adapter, 1.3 A (100 / 240 VAC, SMPS)		
Dimensions (LxWxH); Weight	Meter	16.5 x 23.5 x 8.9 cm ; 1100 g			17.5 x 15.5 x 6.9 cm ; 650 g	
	Boxed	49 x 28 x 16 cm ; 3990 g			30.8 x 23.5 x 12.4 cm ; 1800 g	

\* Maximum 199.9 ppt depending on factor setting \*\* Maximum 500.0 ppt depending on factor setting





## Turbidity



Cloudy appearance of a fluid caused by suspended microscopic particles.

**Handheld:**

1. TN 100

**Bench:**

1. CyberScan TB 1000

## Colorimetry

The measurement of a parameter whose concentration is proportional to the colour intensity with the help of added reagent.

**Handheld:**

1. C 401 Colorimeter
2. C 301 Colorimeter
3. C 201 Colorimeter
4. C 105 Colorimeter
5. C 103 Colorimeter

## About Turbidity & Colorimetric Measurement

### About Turbidity

Turbidity, measured in Nephelometric Turbidity Units (NTU), refers to the concentration of undissolved, suspended particles present in a liquid. It is a measure of sample clarity, not colour. The cloudier a sample, the higher the turbidity reading. High turbidity is caused by particles such as silt, clay, microorganisms and organic matter. By definition, turbidity is not a direct measure of these particles, but how these particles scatter light.

Turbidity is an important parameter in many manufacturing operations, such as food and beverage and potable water treatment plants. In drinking water applications, the turbidity of water may indicate the presence of bacteria, pathogens or particles that can shelter harmful organisms from the disinfectant process; in industrial processes, turbidity is a parameter to measure the effectiveness of treatment of manufacturing processes.

### Good Turbidity Measurement Techniques

Turbidity is a complex analytical measurement which may be affected by several factors. Some are inherent in the instrument's design such as angle of detection, light beam aperture, incident beam wavelength and colour sensitivity of the photocell. However, there are other factors such as stray lights, air bubbles and damaged vials which can be prevented through proper care of equipment and accessories.

1. **Maintain sample vials in good condition.** Vials should be meticulously cleaned and free from significant scratches. Treat the outside of each vial with a thin coat of silicon to mask minor imperfections and scratches that may catch stray lights during measurement. Handle sample vials by the top to avoid fingerprints that may interfere with the light path. If vials are corrupted, discard immediately.
2. **Timeliness of sample.** Samples may change over time due to temperature change or settling of particles. Temperature can affect particles characteristics or create more particles if precipitates form. Similarly, dilution water may change particles characteristics or dissolve particles. Samples should therefore not be drawn and allowed to sit while the meter warms up.
3. **Swirl samples gently.** Shaking samples violently may cause particles to break apart, or air bubbles to form.
4. **Do not mix and match accessories.** Sample vials should be used only with the instruments that are intended for.
5. **Perform visual observation of sample vial before each measurement.** Ensure no visible bubbles in the sample.
6. **Samples placed in the turbidimeter should be at the same temperature as the process flow samples.** Temperature change may cause precipitation of soluble compounds and affect readings.

**The Eutech, CyberScan TB 1000 turbidimeter, meets the performance criteria specified by the US EPA method 180.1 for NTU measurement; the infrared light source models also meet the ISO 7027 standards of measurement. The Eutech waterproof handheld, TN 100 turbidimeter, features laboratory accuracy and excellent repeatability with US EPA approved non-formazin standards. It similarly meets the ISO 7027 standards of measurement.**

### About Colorimetry

Different chemical substances absorb different visual light frequencies. Since the absorbance of a substance is proportional to its concentration (ie. a more concentrated solution gives a higher absorbance reading), the concentration of a known solute can be measured using a colorimeter.

Colorimetry is most widely used in swimming pools, spas, public utilities, industrial wastewater plants, municipal water, treated water, water conditioning systems and paper and pulp mills. The effectiveness of the disinfectants used depends on your system's overall water chemistry, and not just on the disinfectants' concentrations alone.

**Chlorine.** Chlorine and chlorine-release compounds are frequently used as disinfectants in swimming pools, drinking water and other water treatment systems. Routine chlorination kills harmful microorganisms. The disinfection efficiency is a direct function of the level of free chlorine in a system. Total chlorine is the sum of combined and free chlorine. In applications where there is human contact with the water e.g. in swimming pools and spas, it is essential that the right amount of chlorine is present. Insufficient chlorine will decrease the disinfectant efficiency; while excess chlorine will cause skin and eye irritation and become a health hazard. **Eutech's C 401, C 301 and C 201 colorimeters measure free and total chlorine over the range of 0 mg/L to 6 mg/L.**

**Chlorine Dioxide.** The use of chlorine dioxide as a disinfectant is seeing growth in many industrial applications. Unlike chlorine, chlorine dioxide remains a true gas dissolved in solution. The lack of any significant reaction of chlorine dioxide with water is partly responsible for its retaining its disinfecting effectiveness over a wide pH range. This property makes it a logical choice for cooling systems operated in the alkaline pH range, or cooling systems with poor pH control. **Eutech's C 103 colorimeter measures chlorine dioxide over the range of 0 ppm to 11.4 ppm.**

**Ozone.** Ozone is one of the strongest and most rapid oxidisers and disinfectants available. It does not corrode nor cause scaling. In addition, ozone has no smell, does not cause skin nor eye irritation and does not pose a health hazard. Although more expensive than traditional disinfectants like chlorine and bromine, because it does not cause corrosion nor scaling, the long-term maintenance cost of a water system which uses ozone as a disinfectant may be reduced compared to using chlorine. Ozone is gaining popularity in top spas and certain swimming pools. **Eutech's C 105 colorimeter measures ozone over the range of 0 ppm to 4.1 ppm.**

**Cyanuric Acid.** In applications where chlorine is used for disinfection, cyanuric acid is often present as a chlorine stabiliser. Low levels of cyanuric acid are beneficial as they prevent wastage of free chlorine by the sun's UV rays. High levels of cyanuric acid cause the chlorine to take a longer time to kill the micro-organisms. It is important to determine how much cyanuric acid should be added to maximise chlorine efficiency. **Eutech's C 401 colorimeter measures cyanuric acid over the range of 5 ppm to 90 ppm.**

**pH.** The pH value affects the amount of free chlorine that is formed, and therefore determines the effectiveness of chlorine as a disinfectant. As pH increases, the disinfecting power of chlorine decreases. High pH causes scaling of water surfaces, pipework and fittings; this may result in cloudy water. Low pH can corrode metals in pipework and fittings; this may cause metal oxides to stain water surfaces. **Eutech's C 401 and C 301 colorimeters measure pH over the range of 5.9 - 8.2.**



## CyberScan TB 1000

Turbidity

Whether it's outfield measurements on-the-go or laboratory work with stringent requirements, turbidity measurement is a breeze with Eutech's TN 100 and CyberScan TB 1000 turbidimeters. ISO 7027 compliant and equipped with automatic multi-point push button calibrations, Eutech's auto-ranging turbidity instruments are your assurance to high-quality full-range accuracy every time you measure.

Direct meter-to-PC data transfer through RS232C communication



Quick reference slide-out guide

Pour-through assembly module for instantaneous sampling without the need for cuvettes\*

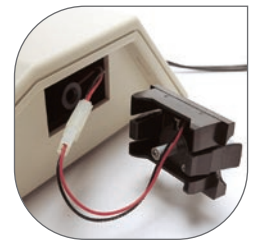

Quick connect light source for low maintenance

### CyberScan TB 1000

- Up to 3-point push-button calibration and full-range accuracy of  $\pm 2\%$  full scale accuracy
- Auto-ranging
- For fast response and best resolution (up to 0.01 NTU) over wide measurement range
- White light TB 1000 designed to meet US EPA method 180.1 ; infrared TB 1000 designed to meet ISO 7027 and DIN 27027 specifications for turbidity measurements
- Prompts at user-defined interval to ensure regularly scheduled recalibration
- GLP-compliant time/date stamp
- Self-diagnostic

\* Optional pour-through assembly accessory (order code: ECPORHASSY)



## TN 100

Turbidity

### TN 100

- Full range lab-accurate results with 4-point push-button calibration – no need to follow sequential order during calibration
- Rapid meter requires only 6 seconds for full-step change
- 1200 tests on a single set of AAA batteries with advance power management design
- Lightweight, waterproof to IP67 standard & floats on water
- US EPA-approved non-formazin standards – more stable with no pollution to the environment
- Comes complete in sturdy carry kit with calibration standards, curvettes, batteries & instruction manual



Large custom-designed LCD

### Applications

Ideal for beverage production, drinking water, swimming pool, aquariums, aquaculture and environmental applications.



## Turbidity

Turbidity Meters Specifications  
& Ordering Information

### Models

### CyberScan Deluxe Bench

### Waterproof Turbidity Meter Single-Display

TB 1000W

TB 1000IR

TN 100

## Turbidity Meters Specifications



Measuring Parameter	Turbidity	
Highlights	Turbidity bench, GLP, RS232C	Light weight, IP67 waterproof meter
Principle	Nephelometric non-ratio / ISO7027 compliant	
Range	0 to 1000 NTU	
Automatic Range Selection	0.00 to 9.99 NTU 10.0 to 99.9 NTU 100 to 1000 NTU	0.01 to 19.99 NTU 20.0 to 99.9 NTU 100 to 1000 NTU
Resolution	0.01 NTU (0 to 9.99 NTU) 0.1 NTU (10 to 99.9 NTU) 1 NTU (100 to 1000 NTU)	0.01 NTU (0 to 19.99 NTU) 0.1 NTU (20.0 to 99.9 NTU) 1 NTU (100 to 1000 NTU)
Accuracy	±2 % of reading	
Repeatability	≤ ±1 % of reading	
Calibration	1 to 3-points (automatic)	4-points
Calibration Standards	0.02 NTU, 10.0 NTU, 1000 NTU	0.02 NTU, 20.0 NTU, 100 NTU, 800 NTU
Response Time	< 6 secs for full step change	
Sample Volume	30 ml	10 ml
RS232C Output	Yes	–
Light Source	White light (tungsten)	Infra-red
Operating Temperature Range	0 to 40 °C	0 to 50 °C
Sample Temperature Range	0 to 50 °C	
Enclosure Type & Rating	ABS plastic	
Power	UL, CSA approved 12 V DC adapter	4 x 1.5 V 'AAA' alkaline batteries (>1200 reading)
Dimensions Meter (LxWxH); Weight Boxed	25.4 x 23.7 x 12.1 cm ; 1550 g	15.5 x 6.8 x 4.6 cm ; 200 g
	35.5 x 31.5 x 25 cm ; 2380 g	35.5 x 16.5 x 10.5 cm ; 1160 g

### Turbidity Meters

Item	Order Code	Part No.	Parameter	Light Sources			Accessories					
			Turbidity	White Light	Infra-Red Light	Calibration Kit (ECTBDWCALKT)	Calibration Kit (ECTBDIRCALKT)	Calibration Kit (ECTN100CALKT)	220 VAC Power Adapter	120 VAC Power Adapter	3 Sample Vials	Turbidimeter Carry Case
TB 1000W	ECTBDW100020	01X259106	•	•		•			•			
TB 1000W	ECTBDW100010	01X259105	•	•		•				•		
TB 1000IR	ECTBDIR100020	01X259104	•		•		•		•			
TB 1000IR	ECTBDIR100010	01X259103	•		•		•			•		
TN 100	ECTN100IR	01X357301	•		•			•			•	•

### Accessories

Used With	Description	Order Code	Part No.
TB 1000W / TB 1000IR	Pack of 3 sample cuvettes	ECTBDCUV03KT	01X265701
TB 1000W / TB 1000IR	RS232C communication cable	ECMICRO100CBL	30X219502
TB 1000W / TB 1000IR	110 / 120 VAC power adapter (50 / 60 Hz); 2-flat pin US type, 12 VDC 800 mA	EC120ADA800	60X030110
TB 1000W / TB 1000IR	220 / 230 VAC Power adapter (50 / 60 Hz); 2-round pin Euro type, 12 VDC 800 mA	EC220ADA800	60X030109
TB 1000W	Calibration kit set – standard solutions (0.02, 10.0, 1000 NTU)	ECTBDWCALKT	01X265101
TB 1000W	Tungsten filament lamp module	ECTNGSTNLMP	01X265301
TB 1000IR	Calibration kit set – standard solutions (0.02, 10.0, 1000 NTU)	ECTBDIRCALKT	01X265102
TB 1000IR	Infrared lamp module	ECINFRDLMP	01X265302
TN 100	Calibration kit set – standard solutions (0.02, 20.0, 100, 800 NTU)	ECTN100CALKIT	01X274802
TN 100	Pack of 3 sample cuvettes	ECTN100CUVKIT	01X274902
TN 100	Silicone oil (10 ml)	ECSILICONEOIL	01X358701
TN 100	Internal batteries (pack of 2)	ECBATT3032	01X265901

## C 401 ; C 301 ; C 201 ; C 105 ; C 103 Colorimeters

Free & Total Chlorine/Cyanuric Acid/pH ; Free & Total Chlorine/pH ; Free & Total Chlorine ; Ozone ; Chlorine Dioxide

Fuss-free and easy to use with no need for pre-calibration! Eutech's range of colorimeter provides quality, highly-repeatable results in just three simple steps. Each colorimeter comes complete with reagents and sample vials in a rugged carrying case – convenient for testing in the field.



Comes with accessories, conveniently packed in a rugged carry kit

One-time blanking, great for multi-parameter analysis or repeated measurements

Lightweight meter floats



IP67 waterproof

Straightforward keypad



High quality, custom-formulated powder reagents for exceptional accuracy, repeatability and stability

### Three Easy Steps



**Step 1:** To blank the meter, place a vial of sample liquid into the meter's sample well. Press the 'ZERO' button. The meter flashes 'STDBY' while blanking is in progress and displays 'ZERO' to confirm that blanking is complete



**Step 2:** Add reagent into sample vial (according to the specified parameter test procedure). Secure vial in meter sample well



**Step 3:** Press 'READ/ENTER' to measure desired parameter

- Excellent test-to-test repeatability, auto-ranging and convenience with only one-vial-one-sachet per test
- Fuss-free meter operation with one-time blanking for all parameters and ranges. No pre-calibration required for chlorine and cyanuric acid
- No detachable parts, no flip covers – high quality customised vials fit perfectly into the sample vial
- Chlorine measurements are based on US EPA-approved DPD method
- Custom formulated high quality powder reagents provide excellent accuracy, repeatability and stability
- 100 % dustproof and waterproof to IP67 standards
- Advanced power management with more than 3000 tests per set of four new 'AAA' alkaline batteries and auto-off function

### Applications

- Swimming pools • Spas • Public utilities
- Industrial wastewater plants • Municipal water • Treated water • Water conditioning systems • Paper and pulp mills





## Colorimetry

Colorimeters Specifications  
& Ordering Information

### Models

### Colorimeters

C 401    C 301    C 201    C 105    C 103



## Colorimeters Specifications

	Range	Resolution	Accuracy	C 401	C 301	C 201	C 105	C 103
Chlorine, Free & Total	0 to 1.99 ppm 2.0 to 6.0 ppm	0.01 ppm 0.1 ppm	±0.02 ppm ±0.2 ppm	✓	✓	✓	-	-
pH	5.9 to 8.2 pH	0.1 pH	±0.1 pH	✓	✓	-	-	-
Cyanuric Acid	5 to 90 ppm	1 ppm	±4 ppm	✓	-	-	-	-
Chlorine Dioxide	0 to 3.79 ppm 3.8 to 11.4 ppm	0.01 ppm 0.1 ppm	±0.02 ppm ±0.2 ppm	-	-	-	-	✓
Ozone	0 to 1.39 ppm 1.4 to 4.1 ppm	0.01 ppm 0.1 ppm	±0.02 ppm ±0.2 ppm	-	-	-	✓	-
Measurement Method	Photometric							
Light Source	Light emitting diode (LED)							
Wavelength	525 nm							
Detector	Silicon photodiode							
Absorbance Range	0 to 2.5 Abs							
Photometric Precision	±0.0015 Abs							
Cal. Points	User-selectable ; 1-point per colorimetric test							
LCD Display	4-digit 14-segments customised LCD with annunciations							
Sample Vials	Borosilicate glass with screw caps, fill line and indexing mark (height x diameter: 5.1 x 2.5 cm)							
Sample Required	10 ml (0.33 oz)							
Operating Temperature Range	0 to 50 °C / 32 to 122 °F							
Sample Temperature Range	0 to 50 °C / 32 to 122 °F							
Operating Humidity Range	0 to 90 % RH non-condensing at 30 °C							
Power	4 x 1.5 V 'AAA' alkaline batteries							
Battery Life	> 3000 tests							
Electromagnetic Compliance (EMC)	Emitted interference - EN 61326 Immunity to interference - EN 61326							
IP67	Yes							
Insulation Rating	Pollution degree 2							
Dimensions Meter (LxWxH); Weight Boxed	15.5 x 6.8 x 4.6 cm ; 200 g 35.5 x 16.5 x 10.5 cm ; 1170 g							

### Colorimeters

Item	Order Code	Part No.	Parameters					Accessories						
			Chlorine, Free & Total	pH	Cyanuric Acid	Chlorine Dioxide	Ozone	Reagent (94X377001)	Reagent (94X377002)	Reagent (94X377003)	Reagent (94X377004)	Reagent (94X377005)	4 Sample Vials	Colorimeter Carry Case
C 401	ECC401	01X376906	•	•	•			•	•	•	•		•	•
C 301	ECC301	01X376905	•	•				•	•	•	•		•	•
C 201	ECC201	01X376904	•					•	•				•	•
C 103	ECC103	01X376915				•		•				•	•	•
C 105	ECC105	01X376917					•		•				•	•

### Accessories

Used With	Description	Order Code	Part No.
C 401 / C 301 / C 201 / C 103 / C 105	Chlorine colour reference kit set	ECCLCOLORREF	01X274806
C 401 / C 301 / C 201	Free chlorine (DPD) reagent kit, pack of 100 pouches	94X377001	94X377001
C 401 / C 301 / C 201	Total chlorine (DPD) reagent kit, pack of 100 pouches	94X377002	94X377002
C 401 / C 301	pH indicator (phenol red) reagent kit, 1 bottle	94X377004	94X377004
C 103	Chlorine dioxide (glycine) reagent kit, pack of 100 pouches	94X377005	94X377005



## Temperature

The degree of hotness or coldness of a body or environment; A measure of the average energy possessed by the molecules of a body.

**Handheld:**

1. Thermo Scientific Temp 360
2. Thermo Scientific Temp 300
3. Thermo Scientific Temp 10 Series
4. EcoScan Temp JKT
5. EcoScan Temp 6
6. EcoScan Temp 5

## About Temperature Measurement

### Introduction to Thermometry

Thermometry is the measurement of temperature or temperature changes. Temperature measurements are necessary in various industries ranging from agriculture, HVAC, chemical and manufacturing, food and beverage, boiler and cooling towers, schools and laboratories to water and wastewater treatment. There are various types of thermometers that rely on different principles of measurement.

**Eutech offers the user-friendly and feature-packed EcoScan temperature meters Temp 5, Temp 6 and Temp JKT for routine indoor and outdoor temperature measurements. The EcoScan Temp 5 and Temp 6 are paired with the 100K thermistor temperature probe and 3-wire RTD Pt 100 temperature probe respectively.**

### What is a Thermocouple?

Thermocouple probes are composed of two dissimilar metals, joined to produce a voltage at a given temperature. Thermocouple thermometers measure, amplify, linearise and display the proportional voltage signal generated by the thermocouple probe. Thermocouples are used in most general purpose applications where precision is not a top priority. They offer a wide temperature range and come in a variety of metal combinations or calibrations.

The J, K and T are three of the most common calibrations available. Although the maximum temperature differs with the diameter of the wire used in the thermocouple, each calibration consists of a different temperature range and environment.

#### Type J and K Probes:

$\pm 1$  to  $4\text{ }^{\circ}\text{C}$  or  $\pm 0.4\%$  probes of reading above  $0\text{ }^{\circ}\text{C}$ , whichever is greater

#### Type T Probes:

$\pm 0.5$  to  $2\text{ }^{\circ}\text{C}$  or  $0.4\%$  of reading above  $0\text{ }^{\circ}\text{C}$ , whichever is greater

### Thermocouple Selection

Some of the following criteria determine the selection of a suitable thermocouple:

- Temperature range
- Chemical resistance of the thermocouple or sheath material
- Abrasion and vibration resistance
- Installation requirements (may need to be compatible with existing equipment; existing holes may determine probe diameter)

The EcoScan Temp JKT is designed for measurement with the Type J, Type K and Type T thermocouples. The meter is capable of measuring a wide range of temperatures and is rugged, dust-proof and splash-proof to IP54 standards, making it suitable for most industrial applications.

### Thermocouple Probe Junction Types

Sheaths with small diameters have faster response times. Sheaths with larger diameters have longer life and are better for measuring higher temperatures.

### Probe Sheath Materials



**INCONEL® 600 Sheath** is ideal for severely corrosive environments and at elevated temperatures. It resists progressive oxidation. Maximum operating temperatures are: continuous –  $1149\text{ }^{\circ}\text{C}$ , intermittent –  $1371\text{ }^{\circ}\text{C}$ .

**304 SS Sheath** is for general purpose use. It is corrosion-resistant, and is good for food service and biological applications. Maximum operating temperatures: continuous –  $899\text{ }^{\circ}\text{C}$ , intermittent –  $1399\text{ }^{\circ}\text{C}$ .

**316 SS Sheath** has higher corrosion resistance than 304 SS. It withstands some strong acids. Maximum operating temperatures: continuous –  $899\text{ }^{\circ}\text{C}$ , intermittent –  $1371\text{ }^{\circ}\text{C}$ .

**SS Sheath with Coating of HDPE** with grounded junction is ideal with corrosive liquids and atmospheres. It has a longer response time and can measure temperatures to  $260\text{ }^{\circ}\text{C}$ .

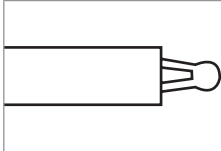
**Eutech offers various probes with ungrounded junction and 304 SS sheath. Models include the Type J and Type K probes available for general purpose immersions in liquids or penetration in meats, plastic and other semi-soft materials.**

	<b>Exposed Junction</b> has the fastest response time making it ideal for measuring rapid temperature changes. Clear coating on most models provides a humidity barrier for the thermocouple. However, it is not recommended for use with corrosive fluids or atmospheres.
	<b>Ungrounded Junction</b> has a welded junction insulated from the protective sheath and is electrically isolated. Longer response time is expected. Recommended use for conductive solutions or where isolation of the measuring circuitry is required.
	<b>Grounded Junction</b> has a junction welded to tip of sheath. Wires are completely sealed from contaminants. Good response time.

### What is a Thermistor?

Thermistors are thermally sensitive resistors which change electrical resistance due to temperature changes. They have predictable characteristics and offer long term stability. Although response times are generally faster than other types of probes, thermistors have a limited temperature range that usually cannot exceed  $150\text{ }^{\circ}\text{C}$ .

**The Eutech EcoScan Temp 5 has a measurement range of 40.0 to 125.0 °C using the 100K thermistor temperature probe.**

### What is RTD?

RTD or Resistance Temperature Detector refers to the measurement of temperature by measuring the change in electrical resistance across metal wires. This resistance value is interpreted by an RTD thermometer. Although the RTD wire can be made of any metal, platinum is preferred for its excellent repeatability, stability and resistance to corrosion and chemicals. RTDs are more accurate and stable compared to other probes such as thermocouples. However they are not recommended for extreme temperatures. An RTD probe is chosen where accuracy and repeatability are important.

**The Eutech EcoScan Temp 6 is a RTD temperature meter which can be used with the 3-wire RTD Pt 100 temperature probe for accurate and reliable measurements.**



# Thermo Scientific Temp 360

Precision RTD Datalogging Thermometer

The Thermo Scientific Temp 360 Precision RTD Datalogging Thermometer is your choice for fast, reliable and highly-precised measurements across a wide temperature range. Rugged and easy to use, the Temp 360 datalogger features a large backlit dual-line LCD, giving you clear, accurate readings, even in dark environments.



Large, easy-to-read illuminated display

0.01 °C resolution

Splash resistant keypad

Rugged design



USB output for advanced data handling with your computer



Protective rubber armor doubles up as a table-top stand



Hang the meter from a pipe or belt



Protective rubber armor ensures a firm grip

- Log up to 2000 data points automatically at intervals from one second to 60 minutes, or manually at the touch of a button
- Easy calibration – choose one-point or two-point
- Minimum, maximum and differential temperature view at the press of a button
- Large, easy-to-read illuminated display
- Exclusive three-way hands-free option\* – hang the meter from a pipe or belt, stick the meter to a metallic surface, or simply stand the meter on a table surface
- USB output for advanced data handling with your computer
- IP54 splashproof with sealed keypad and ABS plastic housing
- Protective rubber armor ensures a firm grip and doubles up as a table-top stand

\* Sold separately



## Applications

- General manufacturing • F&B manufacturing • Instruments manufacturing • Electrical equipment
- Chemical industries • Aquaculture • HVAC
- Construction • Education • Cosmetics
- Pharmaceuticals • Environmental • Plastics & rubber • Forest products • Printing
- Glass & cement • Research • Greenhouse
- Textiles • Healthcare • Transportation
- Utilities • Water filtration

## Thermo Scientific Temp 300

Dual-Input Thermocouple Datalogging Thermometer

Differential temperature measurement is a breeze with the Thermo Scientific Temp 300 Dual-Input Thermocouple Datalogging Thermometer. With a user-friendly interface, this dual-input thermocouple handheld allows users to navigate through setup and operation easily, even without a manual. Ergonomically designed, the Temp 300 fits your palm perfectly and comes with a large backlit LCD for working in dark environments.



USB output for advanced data handling with your computer



Protective rubber armor doubles up as a table-top stand



Hang the meter from a pipe or belt



Protective rubber armor ensures a firm grip



Large, easy-to-read illuminated display

Datalogging capabilities

Menu-driven operation

### Applications

- General manufacturing • F&B manufacturing • Instruments manufacturing • Electrical equipment
- Chemical industries • Aquaculture • HVAC
- Construction • Education • Cosmetics
- Pharmaceuticals • Environmental • Plastics & rubber • Forest products • Printing
- Glass & cement • Research • Greenhouse
- Textiles • Healthcare • Transportation
- Utilities • Water filtration

- Accepts J, K, T, E, R, S, N and B thermocouple probes
- Multi-line display shows individual and differential temperatures simultaneously
- Log up to 2000 data points automatically at intervals from one second to 60 minutes, or manually at the touch of a button
- Easy calibration – choose one-point or two-point, calibrate channels separately or match one probe to the other
- Large, easy-to-read illuminated display
- Exclusive three-way hands-free option\* – hang the meter from a pipe or belt, stick the meter to a metallic surface, or simply stand the meter on a table surface
- USB output for advanced data handling with your computer
- IP54 splashproof with sealed keypad and ABS plastic housing
- Protective rubber armor ensures a firm grip and doubles up as a table-top stand

\* Sold separately



# Thermo Scientific Temp 10 Series

Single-Input Thermocouple Thermometers

Rugged and easy to use, the Thermo Scientific Single-Input Thermometers each comes with a large, backlit dual-line LCD, giving you clear, accurate readings of measured and min/max temperature, even in dark environments.

The Temp 10 single RTD thermometer series consist of three models – J, K or T – for your basic temperature measurement needs.

The Temp 16 RTD Thermometer gives you fast, reliable and highly precise measurements across a wide temperature range.



Magnets hold the meter to any metallic surface



Protective rubber armor doubles up as a table-top stand



Hang the meter from a pipe or belt



Protective rubber armor ensures a firm grip

- Temp 10 Series measures from -250 to 1372 °C; Temp 16 features high precision measurements from -200.0 to 850.0 °C (-392.0 to 1562 °F)
- Automatic calibration – just leave electrode in ice water and press 'CAL' to calibrate
- Min/max temperature at the press of a key – dual-display shows current and min/max readings
- Large, easy-to-read illuminated display
- Accepts a wide variety of temperature probes using standard mini-connector
- Exclusive three-way hands-free option\* – hang the meter from a pipe or belt, stick the meter to a metallic surface, or simply stand the meter on a table surface
- IP54 splashproof with sealed keypad and ABS plastic housing
- Protective rubber armor ensures a firm grip and doubles up as a table-top stand

\* Sold separately



### Applications

- General manufacturing • F&B manufacturing • Instruments manufacturing • Electrical equipment
- Chemical industries • Aquaculture • HVAC
- Construction • Education • Cosmetics
- Pharmaceuticals • Environmental • Plastics & rubber • Forest products • Printing
- Glass & cement • Research • Greenhouse
- Textiles • Healthcare • Transportation
- Utilities • Water filtration



## Temperature

Thermo Scientific Handhelds  
Specifications

## Temperature Handheld Meters Specifications



Models	Thermo Scientific Thermometers					
	Temp 360	Temp 300	Temp 16	Temp 10J	Temp 10K	Temp 10T
Measuring Parameter	°C / °F					
Highlights	Precision RTD Datalogger	Type J, K, T, E, N, R, S & B Dual Input Thermocouple	Single Input Precision RTD	Type J Single Input Thermocouple	Type K Single Input Thermocouple	Type T Single Input Thermocouple
Range	-201 to 1210 °C / -330 to 2210 °F	Type J: -210 to 1200 °C / -346 to 2192 °F Type K: -250 to 1372 °C / -418 to 2501 °F Type T: -250 to 400 °C / -418 to 752 °F Type E: -250 to 1000 °C / -418 to 1832 °F Type R: 0 to 1768 °C / 32 to 3214 °F Type S: 0 to 1768 °C / 32 to 3214 °F Type N: -250 to 1300 °C / -418 to 2372 °F Type B: 200 to 1800 °C / 392 to 3272 °F	-200.0 to 850.0 °C / -392 to 1562 °F	-210 to 1200 °C / -346 to 2192 °F	-250 to 1372 °C / 418 to 2501 °F	-250 to 400 °C / -418 to 752 °F
Resolution	From -330.0 to -100 °C/°F: 0.1 °C/°F From -99.99 to 99.99 °C/°F: 0.01 °C/°F From 100.0 to 999.9 °C/°F: 0.1 °C/°F Above 1000 °C/°F: 1 °C/°F	Auto-ranging: 0.1/1 °C/°F -199.9 to 999.9 °C/°F: 0.1 °C/°F 1 °C/°F outside this range	-200.0 to 850.0; 0.1 °C -392.0 to 999.9; 0.1 °F 1000 to 1562; 1 °F	Below 1000 °; 0.1 °C/°F Above 1000 °; 1 °C/°F		
Accuracy	From -330.0 to -100 °C/°F: ±0.1 °C / ±0.2 °F From -99.99 to 99.99 °C/°F: ±0.03 °C / ±0.06 °F From 100.0 to 999.9 °C/°F: ±0.1 °C / ±0.2 °F Above 1000 °C/°F: ±1 °C / ±2 °F	For J, K, T, E & N Below -150 °C / -238 °F: ±0.1 % of reading ±0.4 °C / ±1 % ±0.7 °F Above -150 °C / -238 °F: ±0.25 % of reading ±1 °C / ±0.25 % ±0.7 °F For R, S & B ±0.1 % of reading ±1 °C / ±0.1 % ±2 °F	-200.0 °C to -100.0 °C / -392 °F to -148 °F: ±2.0 °C / ±4.0 °F -99.9 °C to 199.9 °C / -148 °F to 392 °F: ±0.2 °C / ±0.4 °F 200.0 °C to 850.0 °C / 392 °F to 1562 °F: ±2.0 °C / ±4.0 °F	Below -150 °; ±0.25 % of reading ±1 °C Above -150 °; ±1 % of reading ±0.4 °C		
Datalogging	2000 points			-		
Logging Interval	1 sec to 60 mins			-		
Min/Max Reading				Yes		
Stability Indicator				Yes		
Storage				-40 to 65 °C / -40 to 149 °F; 10 to 90 % (non-condensing)		
Ingress Protection (With Probe Attached)				IEC-529 IP-54 for dust and water-resistant enclosures		
Compliance (For CE Mark)				EN61326-1/A1: 1998 (EU EMC directive)		
Hold Function				Yes		
Auto-Off				17.5 min (selectable)		
LCD Display				58 x 40 mm with backlight		
Input	Single (3-pin DIN connector)	Double (ANSI connectors)	Single (3-pin circular connector (switchcraft TA3F))	Single (ANSI connector)		
Power				3 x 1.5 V 'AA' alkaline batteries		
Battery Life				> 750 hrs (without backlight)		
Dimensions (LxWxH); Weight	Meter	17.5 x 9.7 x 4.2 cm; 267 g (without armor); 18 x 10.2 x 5.2 cm; 362 g (with armor)				
	Boxed	26 x 13.5 x 7.5 cm; 580 g				

Temperature

## EcoScan Temp JKT ; EcoScan Temp 6 ; EcoScan Temp 5

°C/°F

°C/°F

°C/°F

Ideal for routine indoor and outdoor temperature testing, the EcoScan Temp JKT, Temp 6 and Temp 5 are durable, value-for-money thermometers with user-friendly features.



Large custom screen with min/max display

Protective rubber boot doubles up as stand

Rugged splashproof design

- Selectable °C/°F readout
- Non-volatile memory backup
- Factory calibrated
- Offset adjustment
- Self-diagnostic messages
- Easy push-button calibration
- HOLD and selectable auto power-off function
- EcoScan Temp 5 uses 100K thermistor probes
- EcoScan Temp 6 uses 3-wire RTD PT100 probes
- EcoScan Temp JKT features versatility with interchangeable J, K, T probes

### Applications

**General:** Ideal for applications that require the measurement and monitor of temperature of liquid, solid, semi-solid or gel.

**Industrial:** Can be used in photo developing, chemical and plating industries and all applications that require temperature measurement. Can be used as a practical substitute for glass thermometers in food processing or agriculture applications. The min/max feature is useful for HVAC applications where the measurement and monitor of heating and cooling efficiency is required. Other applications include flue gas temperatures, boiler water, heater jacket temperatures, inlet and outlet water heater temperatures, etc.

**Educational:** Ideal for students with its user-friendly, easy push-button features. No worries about broken glass or mercury spillage.



Models

EcoScan Single-Display

Temp JKT

Temp 6

Temp 5

Temperature  
Handheld  
Meters  
Specifications



Measuring Parameter	°C / °F				
Highlights	Type J Thermocouple	Type K Thermocouple	Type T Thermocouple	3 wire RTD pt100 temperature probe	100K thermistor temperature probe
Range	-200 to 1000 °C / -328 to 1832 °F	-250 to 1372 °C / -418 to 2502 °F	-250 to 400 °C / -4.8 to 752 °F	-200.0 to 850.0 °C / 328.0 to 1562 °F	-40.0 to 125.0 °C / -40.0 to 257 °F
Resolution	1 °C / 1 °F (t < -99.0 °C) 0.1 °C / 0.1 °F (-99.9 °C < t < 299.9 °C) 1 °C / 1 °F (t > 299.9 °C)		0.1 °C / 0.1 °F (-99.9 to 199.9 °C) ; 1 °C / 1 °F (range < -99.9 °C and range > 199.9 °C)		0.1 °C / 0.1 °F
Accuracy	±0.25 % of reading + 1 °C (t < -99.9 °C) ±0.2 % of reading + 0.5 °C (t > -99.9 °C)		±0.2 °C / ±0.4 °F (-99.9 to 199.9 °C) ±2 °C (range < -99.9 °C and range > 199.9 °C)		±0.2 °C / 0.4 °F
Offset Adjustment	±10 °C / ±18 °F				
Hold Function	Yes				
Auto-Off (Selectable)	Yes				
Low Battery Indicator	Yes				
LCD Display	Single custom LCD				
Operating Temperature	-10 to 50 °C / 14 to 122 °F		0 to 50 °C / 32 to 122 °F		
Input	2-pin ANSI mini connector		3-pin panel mount connector		¼ inch phono plug
Power	4 x 1.5 V 'AAA' alkaline batteries				
Battery Life	> 200 hrs				
Dimensions Meter (LxWxH); Weight Boxed	14 x 7 x 3.5 cm ; 200 g 24 x 16.5 x 8.5 cm ; 510 g				

Temperature Handheld Meters

Item	Order Code	Part No.	Type			Temperature Probes			
			Thermocouple Type(s)	RTD	Thermistor	Thermocouple Type J, K, T	Temperature Probe (TEM6/TEM01R)	Temperature Probe (TEM5/TEM01P)	RTD Probes
Temp 10J	TSTEMP10J	01X450405	J			•			
Temp 10K	TSTEMP10K	01X450408	K			•			
Temp 10T	TSTEMP10T	01X450411	T			•			
Temp 16	TSTEMP16-RTD	01X491704		•					•
Temp 300	TSTEMP300	01X523604	J, K, T, E, R, S, N, B			•			
Temp 360	TSTEMP360	01X526504		•					•
Temp JKT	ECTEMPJKT	01X270401	J, K, T			•			
Temp 6	ECTEMP601	01X256503		•			•		
Temp 5	ECTEMP501	01X256502			•			•	

Accessories

Used With	Description	Order Code	Part No.
Type J	General purpose probe (for immersion into liquids), 1 m cable, ungrounded, -50 to 700 °C	ECTPGLPJ01M	01X220001
Type J	Penetration probe (for penetrating meat, plastic and semi-soft materials), 1 m cable, ungrounded, -50 to 700 °C	ECTPPENJ01M	01X220002
Type K	General purpose probe (for immersion into liquids), 1 m cable, ungrounded, -50 to 700 °C	ECTPGLPK01M	01X220101
Type K	Penetration probe (for penetrating meat, plastic and semi-soft materials), 1 m cable, ungrounded, -50 to 700 °C	ECTPPENK01M	01X220102
Type K	Surface probe (for direct contact on hot surfaces), 1 m cable, ungrounded, -50 to 700 °C	ECTPSURK01M	01X220103
RTD	3 wire RTD Pt100 Temperature probe, ungrounded, SS304 (max. Temperature 150 °C)	TEM6TEM01R	01X021814
RTD	RTD Pt100 Temperature probe, round-tip sensor, -50 to +400 °C	ECPT56L	93X375701
Thermistor	100K thermistor Temperature probe, ungrounded, SS304, 0 to 125 °C	TEM5TEM01P	01X021811
Temp 10JKT, 16, 300, 360	Hands-free kit for Thermo Scientific thermometers (2 magnets and a strap)	HNDSFRKIT	01X460701
Temp 10JKT, 16, 300, 360	Rubber armor/stand for Thermo Scientific thermometers	01X460601	01X460601

\* More temperature probes available. Check with your distributor today!



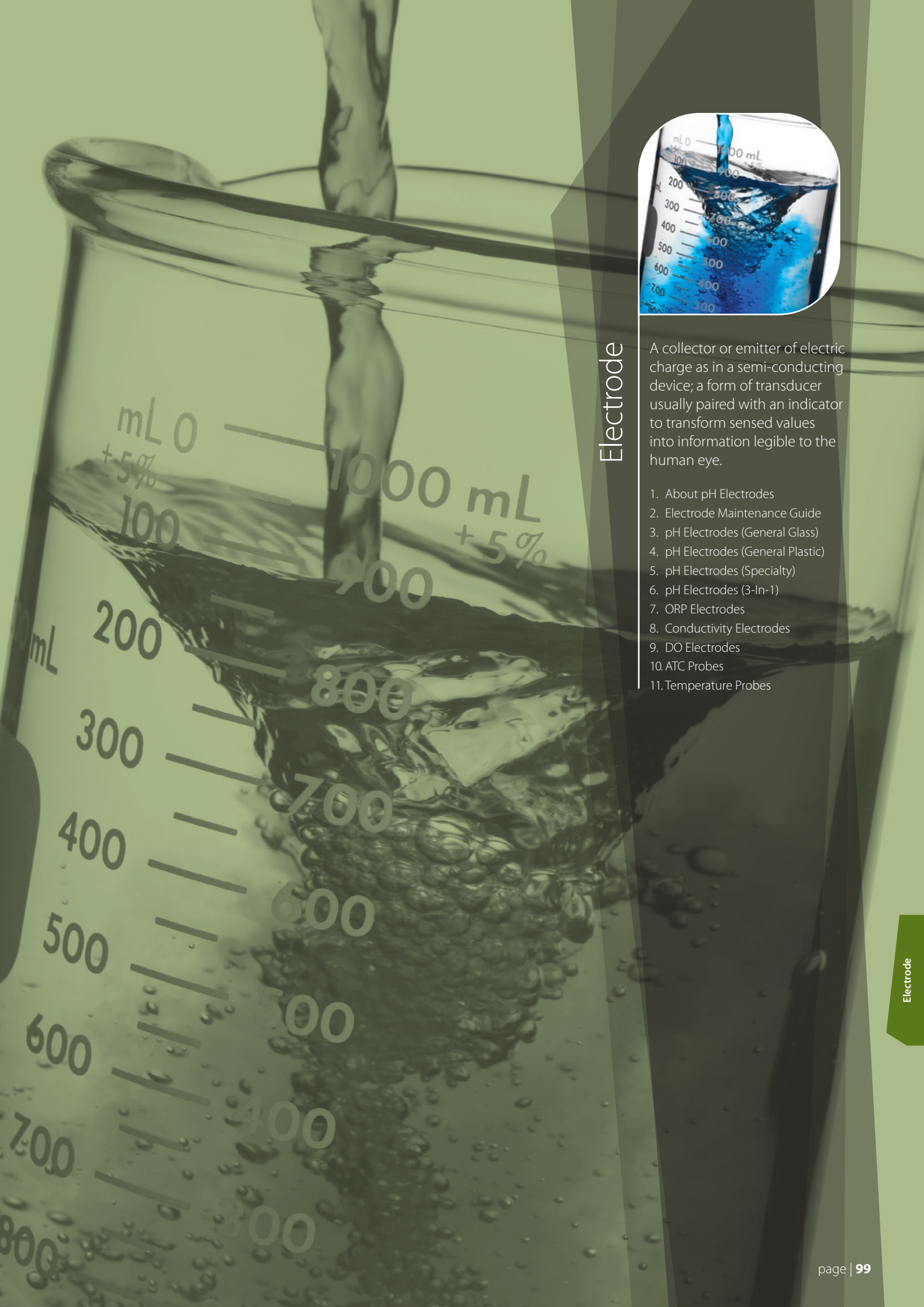

## Electrode

A collector or emitter of electric charge as in a semi-conducting device; a form of transducer usually paired with an indicator to transform sensed values into information legible to the human eye.

1. About pH Electrodes
2. Electrode Maintenance Guide
3. pH Electrodes (General Glass)
4. pH Electrodes (General Plastic)
5. pH Electrodes (Specialty)
6. pH Electrodes (3-In-1)
7. ORP Electrodes
8. Conductivity Electrodes
9. DO Electrodes
10. ATC Probes
11. Temperature Probes

## Electrodes

About pH Electrodes

# About pH Electrodes

### Basic Theory and Application of pH Measurement

pH refers to the power or exponent of hydrogen where 'p' stands for power and 'H' is the symbol of the element Hydrogen.

*pH is defined as the negative logarithm of the molar concentration of the active hydrogen ions,  $pH = -\log H^+$ .*

pH provides a convenient way to compare the relative acidity or alkalinity of a sample at a given temperature. For example, pure water has a neutral pH of 7, where the activities of hydrogen and hydroxide ions are equal. If the activity of hydrogen ion is greater than that of hydroxide ion the sample is described as acidic. In general, as the level of hydrogen ion activity increases, the pH decreases. A pH below 7 is known as acidic. On the contrary, as the level of hydrogen ion activity decreases, the pH increases. A pH above 7 is known as alkaline or basic.

### Use of Electrodes for pH Measurement

pH measurement is usually done with the use of a combination electrode. The combination electrode is an electrode system formed by a glass sensing half-cell and an internal reference half-cell. As the reference junction acts as the medium of conductor between the reference electrolyte and the sample to be measured, it must allow free movement of electrons through the junction and into the sample. A potential develops on the membrane surface when a pH electrode comes into contact with a sample and its value varies with the pH of the sample. This variation in potential is measured in mV by a meter and is converted to direct pH values.

### Slope

The 'slope' is the voltage produced per pH. In theory, the value is 59.16 mV per pH at 25 °C. Practically, the value ranges between 50 and 58 mV.

### Influence of Temperature on pH Measurement

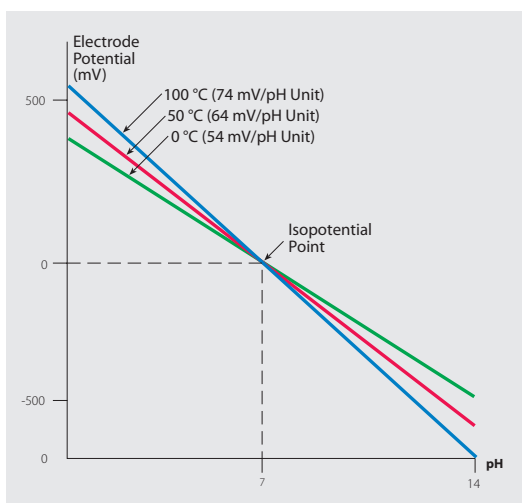

Temperature variations can affect pH. However at a certain pH, usually 7, temperature will not have an effect on the potential of the system. This is known as the 'isopotential point'.

If automatic compensation is not practical, the following equation can be used to determine error:  
Magnitude of error = 0.003 pH/°C/pH unit from pH 7

**Note:** The temperature compensation here refers to electrode related temperature variation and not solution related variations.

### Selection Criteria

Eutech combination electrodes offer the convenience of having the reference and measuring electrodes combined in a single housing. They are offered in a variety of configurations to suit most laboratory and field application needs.

### Electrode Construction



**Glass Body**

- Glass withstands high temperature of 100 °C or more.
- Resistant to corrosive materials and solvents.
- Brittle.
- Ideal for laboratory use and is easy to clean.



**Plastic Body**

- Not recommended for usage at temperature above 80 °C.
- Moderate resistance to highly corrosive materials and solvents.
- Durable and withstands rough handling.
- Ideal for field use.

### Single Vs Double Junction



**Single Junction**

- Ideal for general purpose applications.
- Ag<sup>+</sup> ions are in contact with junction and this can cause chemical interaction with sulphur. Not suitable for biological samples or tris buffers.



**Double Junction**

- Prevents interference between the inner fill solution and sample.
- Electrolyte is free of Ag<sup>+</sup> ions. Suitable for use with biological samples.
- Can be used in place of calomel reference electrodes.

### Internal Reference Types

#### | Silver/Silver Chloride Reference (Ag/AgCl) |

Ag/AgCl reference electrodes are largely hysteresis-free and can be used at a higher temperature with lower temperature coefficients. Ag/AgCl is the best general purpose reference with a wide temperature range (-5 to 110 °C).

#### | Double Junction |

A double junction reference is constructed with an Ag/AgCl inner chamber and a chemically compatible reference solution in the outer chamber. It is recommended for samples containing organic compounds, proteins, heavy metals; and other compounds that interact with silver, such as bromides, iodides, cyanides and sulfides.

### Refillable Vs Sealed Design



**Refillable Design**

- Refill hole allows reference electrolyte replenishment.
- Can be used many times over.
- Needs refilling when fill solution is low.



**Sealed Design**

- No refill hole. The reference electrolyte is usually a gel.
- Replacement of the electrode is necessary when it gets contaminated.
- Virtually no maintenance is required.

### Reference Construction

#### | Refillable Reference Cell |

Selected for high accuracy, stability, and longer electrode life. Refillable types sacrifice convenience and ease of maintenance.

#### | Unique Twist-Cap Design |

Unlike conventional designs which use rubber sleeves, Eutech's 620 series refillable electrodes feature a unique refill-hole with twist-cap design – easy-to-use and leak-proof. Refilling of reference electrolyte is hassle-free and quick with no wastage.



Twist-open the cap to expose the refilling hole



Pour in reference electrolyte with the refilling bottle



Twist-close the cap

#### | Sealed Reference Cell |

Sealed gel-filled reference electrodes are designed for convenience where minimal maintenance is required. Slightly lower accuracy and shorter life must be taken into account.



## Electrodes

About pH Electrodes

### Types of Reference Junctions



**Annular Junction**  
Fast electrode response.



**Porous HDPE Junction**  
Low electrolyte flow, hence more durable.



**Flushable Junction**  
Cleanses by pumping out electrolyte to remove residue, thus eliminates clogging problems in viscous samples.



**Open Pore Junction**  
About 200 times larger than ceramic junctions, ensures increased electrolyte flow for stable junction potential.

### Reference Junctions

Some glass combination electrodes feature an anti-fouling annular ceramic junction. The annular junction is formulated with a special ceramic which encircles the glass bulb. Numerous pores in the ceramic provide lower resistance and more stable pH readings. The plastic body combination electrodes come standard with a porous HDPE pin junction. Sleeve junction provides the highest flow rate for difficult samples.

### General Purpose Vs Specialty Applications

Most electrodes come in different stem lengths and diameters for specific applications.



**General Purpose Applications**  
Usually measures 120 mm (length) by 12 mm (diameter) and can be used for general applications.



**Specialty Applications**  
Effective for specific applications. For instance the spear tip sensor can be used for the direct pH testing of semi-solids and soft materials. Sleeve type electrode ensures high electrolyte flow so it is ideal for low ionic strength and viscous sample measurements. On the other hand, a flat surface tip electrode is used for flat samples like paper or cloth. Micro-stem electrode fits into thin stem NMR tubes or small vessels. For harsh use, a durable tough bulb electrode that is resistant to breakage is recommended.



## Electrode Maintenance Guide

### Use and Care of Electrodes

#### Maintenance and Storage of pH Electrodes

Electrodes are delicate measuring instruments that require proper care and maintenance to produce accurate and reliable results, and to prolong useful life.

Always keep the pH electrode moist when not in use for a period of time, by using an electrode storage solution or a pH 7 buffer as storage media to soak the electrode. DO NOT store the electrode in distilled or deionised water as this will cause ions to leach out of the glass bulb and reference electrolyte, causing slow and sluggish response.

Electrodes may be shipped with either protective caps or in electrode soaking bottles to prevent cracking or scratching, and to keep the glass bulbs moist. Remove the electrode gently from the storage bottle and rinse it with distilled water before use. For long-term storage, always keep the electrode in the bottle, filled with sufficient storage solution to cover the bulb. Replenish the bottle as needed.

#### Handling

The electrode should be rinsed thoroughly between sample measurements and calibrations with distilled or deionised water. Blot the electrode dry to gently dislodge excess water. Use a lint-free wiping paper as rubbing causes the electrode to be charged electrostatically. Never use polymer or plastic body electrodes in samples containing organic solvents.

#### Refillable Electrodes

The filling solution in refillable electrodes should be filled up to, but not past, the refill hole. Make sure that the refill hole is open when measuring to ensure that the fill solution flows properly through the reference junction.

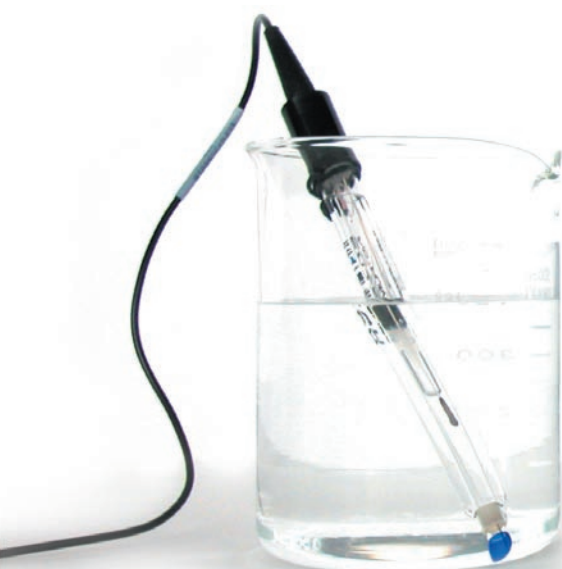

### Rejuvenation and Reconditioning of Electrodes

As electrodes age, their efficiency is reduced. Symptoms include sluggish or erratic readings. This aging is usually caused either by contamination of the glass membrane, or by blockage of the liquid junction reference. Below are a few remedial procedures to improve the performance of such electrodes.

#### Unblocking Reference Junction

A blocked or clogged reference junction attributes to about 80 % of all pH measurement difficulties; resulting in extremely slow response, off-scale readings and electrically noisy measurements. Procedures for unblocking the junction depend on the type of reference junction electrode in use:

- **Gel-Filled Electrodes**  
Soak the electrode in warm water (about 60 °C) for 5 to 10 minutes to re-establish contact. Or place the electrode in warm saturated KCl solution (60 °C) and allow both electrode and solution to cool down to room temperature.
- **Liquid-Filled Electrodes**  
**Sleeve and Annular Junction** – Drain the electrode, rinse the cavity with distilled water and refill it with fresh electrolyte. For sleeve-type electrodes, rotate the sleeve to re-establish flow if necessary.
- **Ceramic Junction**  
**For Silver/Silver Chloride Types Only** – Soak the electrode in warm saturated KCl solution (60 °C) for about 10 minutes, and check for electrolyte flow. Alternatively, soak the electrode tip in concentrated ammonium hydroxide for 5 to 10 minutes (use adequate ventilation and precautionary measures when performing this task). Rinse the electrode, then check for electrolyte flow.  
**For Ceramic Junctions Only** – If the junction remains clogged, gently sand the junction area (be careful not to touch the glass bulb), and check for electrolyte flow.

#### Cleaning Glass pH Membrane

Dirty glass membranes are usually indicated by beads of water forming on the bulb when rinsing with distilled water. The bulb can be cleaned as follows:-

- **For Protein** – Soak in fresh protein removal solution ECDPCBT for 30 minutes, rinse thoroughly before use.
- **For Inorganic Deposits** – Wash with EDTA, ammonia or acids
- **For Grease and Similar Films** – Wash with acetone, methanol, etc.

#### Reconditioning Glass pH Membrane

Prolonged use, excessive alkaline immersion, or high temperature operation will cause surface leaching of the membrane glass; resulting in erratic or sluggish response which cannot be remedied by clearing the electrode. Immerse the electrode tip into 0.1N HCl for less than 5 minutes, and rinse with water. Then immerse the electrode tip into 0.1N KOH for 5 minutes, and rinse thoroughly with water. Check for electrode's performance. If the problem persists, repeat the steps but note that frequent HCl/KOH treatment can shorten the electrode life.



#### Warranty

Eutech Instruments warrants its electrodes to be free from manufacturing defects for 6 months (unless otherwise specified).

## Electrodes

pH Electrodes (General Glass) &  
(General Plastic)

### pH Electrodes (General Glass)





Models	ECFG6350601B	ECFG7350401B	ECFG7370101B	ECFG7351101B	ECFG7451901B	ECFG6351101B
	93X218810	93X218814	93X218819	93X218815	93X218823	93X218828
Parameter	pH	pH	pH	pH	pH	pH
Range	0 to 13 pH	0 to 13 pH	0 to 13 pH	0 to 13 pH	0 to 14 pH	0 to 13 pH
Temp. Range	0 to 100 °C	0 to 100 °C	0 to 100 °C	0 to 100 °C	5 to 110 °C	0 to 100 °C
Liquid Junction Type	Annular ceramic	Annular ceramic	Annular ceramic	Sleeve	Annular ceramic	Annular ceramic
Internal Reference Type	Ag/AgCl	Ag/AgCl	Ag/AgCl	Ag/AgCl	Ag/AgCl	Ag/AgCl
Sealed/Refillable	Refillable	Refillable	Refillable	Refillable	Sealed	Sealed
Reference Junction	Single	Single	Double	Single	Single	Single
Refilling Reference Electrolyte	ECRE001	ECRE001	ECRE002	ECRE001	–	–
Dimensions (Shaft)	55 x 8 mm	130 x 12 mm	110 x 12 mm	110 x 12 mm	110 x 12 mm	55 x 8 mm
Cable Length	1 m	1 m	1 m	1 m	1 m	1 m
Connector	BNC	BNC	BNC	BNC	BNC	BNC
Description	General purpose glass-body pH electrode. Suitable for high viscosity samples where frequent cleaning of reference is required. Comes with 10 ml electrolyte	General purpose glass-body pH electrode with protective sensor guard. Suitable for samples with low temperature measurements. Comes with 10 ml refilling electrolyte	Clog free double-junction glass pH electrode, ideal for samples containing TRIS buffers, sulfides and more. Easy to operate fill hole sleeve mechanism	General purpose glass-body pH electrode with sleeve design for faster response in high viscosity solutions, where frequent cleaning of reference is required	Rugged glass-body pH electrode for continuous, long-term use at high temperatures, particularly in strong alkaline solutions. Suitable for photographic chemicals	Glass-body pH electrode for solid or semi-solid samples
Used With	All pH meters with BNC input connector	All pH meters with BNC input connector	All pH meters with BNC input connector	All pH meters with BNC input connector	All pH meters with BNC input connector	All pH meters with BNC input connector

### pH Electrodes (General Plastic)



Models	ECFC7252101B	ECFC72521R01B	ECFC72522R01B	ECFC7252201B
	01X099412	01X099413	01X099414	01X099417
Parameter	pH	pH	pH	pH
Range	1 to 13 pH	1 to 13 pH	1 to 13 pH	1 to 13 pH
Temp. Range	0 to 80 °C	0 to 80 °C	0 to 80 °C	0 to 80 °C
Liquid Junction Type	Porous HDPE pin	Porous HDPE pin	Porous HDPE pin	Porous HDPE pin
Internal Reference Type	Ag/AgCl	Ag/AgCl	Ag/AgCl	Ag/AgCl
Sealed/Refillable	Sealed	Refillable	Refillable	Sealed
Reference Junction	Single	Single	Double	Double
Refilling Reference Electrolyte	–	ECRE001	ECRE002	–
Dimensions (Shaft)	90 x 12 mm	90 x 12 mm	90 x 12 mm	90 x 12 mm
Cable Length	1 m	1 m	1 m	1 m
Connector	BNC	BNC	BNC	BNC
Description	General purpose plastic-body pH electrode	General purpose plastic-body pH electrode. Comes with 10 ml refilling electrolyte. Available with 3 m cable (ECFC7252203B)	General purpose plastic-body pH electrode. Comes with 10 ml refilling electrolyte. Available with 3 m cable (ECFC7252203B)	General purpose plastic-body pH electrode. Comes with 10 ml refilling electrolyte. Available with 3 m cable (ECFC7252203B)
Used With	All pH meters with BNC input connector	All pH meters with BNC input connector	All pH meters with BNC input connector	All pH meters with BNC input connector



pH Electrodes (Specialty)

Models	EC620130 01X218972	EC620131 01X218973	EC620132 01X218974	EC620133 01X218975
				
Parameter	pH	pH	pH	pH
Range	0 to 14 pH	0 to 14 pH	0 to 14 pH	2 to 11 pH
Temp. Range	0 to 80 °C	0 to 80 °C	0 to 60 °C	0 to 50 °C
Liquid Junction Type	Open pore	Open pore	Open pore	Open pore
Internal Reference Type	Ag/AgCl	Polymer-gel	Polymer-gel	Polymer-gel
Sealed/Refillable	Refillable	Sealed	Sealed	Sealed
Reference Junction	Double	Double	Double	Double
Refilling Reference Electrolyte	EC636430	–	–	–
Dimensions (Shaft)	140 x 12 mm	120 x 12 mm	105 x 12 mm	80 x 6 mm
Cable Length	1 m	1 m	1 m	1 m
Connector	BNC	BNC	BNC	BNC
Description	Open pore glass-body pH combination electrode for general pH measurements. Comes with 10 ml refilling electrolyte	Open pore glass-body pH electrode for general testing and high viscosity solutions where frequent cleaning of reference is required	Open pore plastic-body pH electrode for general pH measurements.	Open pore glass-body spear tip electrode. Suitable for semi-solid samples.
Used With	All pH meters with BNC input connector	All pH meters with BNC input connector	All pH meters with BNC input connector	All pH meters with BNC input connector

pH Electrodes (Specialty)

Models	EC620185 93X218946	ECDA9350603B 93X218879	ECCOMBI03M 01X234601
			
Parameter	pH	pH	pH/Conductivity/Temperature
Range	0 to 14 pH	1 to 14 pH	1 to 13 pH / 0 to 20 mS/cm
Temp. Range	-5 to 100 °C	0 to 50 °C	0 to 80 °C
Liquid Junction Type	Annular ceramic	Annular ceramic	Porous HDPE pin
Internal Reference Type	Ag/AgCl	Ag/AgCl	Ag/AgCl
Sealed/Refillable	Refillable	Sealed	Refillable
Reference Junction	Double	Single	Single
Refilling Reference Electrolyte	ECRE002	–	–
Dimensions (Shaft)	106 x 10 mm	151 x 26 mm	155 x 55 mm
Cable Length	1 m	3 m	3 m
Connector	BNC	BNC	6-pin
Description	Fast-responding glass-body electrode with extra rugged bulb design. Suitable for applications where frequent breakage of glass bulbs is a problem, but unsuitable for epoxy electrodes. Comes with 10 ml electrolyte	Submersible ABS-body gel-filled electrode	Combined pH electrode and 2-pin stainless steel conductivity electrode with 15 cm ABS guard
Used With	All pH meters with BNC input connector	All pH meters with BNC input connector	PC 10

## Electrodes

pH Electrodes (3-in-1) & ORP Electrodes

### pH/ATC Electrodes (3-in-1)

Models	ECFC7352901B 01X218964	ECFC7352901W 01X218995	ECFE7352801B 93X218835
Parameter	pH/Temperature	pH/Temperature	pH/Temperature
Range	1 to 13 pH	1 to 13 pH	1 to 13 pH
Temp. Range	0 to 80 °C	0 to 80 °C	0 to 80 °C
Liquid Junction Type	Porous HDPE pin	Porous HDPE pin	Porous HDPE pin
Internal Reference Type	Ag/AgCl	Ag/AgCl	Ag/AgCl
Sealed/Refillable	Sealed	Sealed	Sealed
Reference Junction	Single	Single	Single
Refilling Reference Electrolyte	–	–	–
Dimensions (Shaft)	90 x 12 mm	90 x 12 mm	115 x 12 mm
Cable Length	1 m	1 m	1 m
Connector	BNC & 2.5 mm phono	BNC & 6-pin	BNC & phono plug
Description	General purpose plastic-body "3-in-1" pH/ Temperature combination electrode	General purpose plastic-body "3-in-1" pH/ Temperature combination electrode	General purpose plastic-body "3-in-1" pH/ Temperature combination electrode
Used With	pH 110 / pH 11 / Ion 510 / pH 510 / pH 2100 / pH 1100 / Ion 6+ / pH 5+ / pH 6+	PC 510 / PC 300 / pH 310 / pH 300	Discontinued CyberScan models – pH 10 / pH 100 / pH 200 / pH 500 / pH 1000 / pH 2000

### Oxidation Reduction Potential (ORP) Electrodes

Models	ECFC7960101B 01X256612	ECFC7960201B 01X256613	ECFC79601R01B 01X254014	ECFC79602R01B 01X256621	ECFG7960101B 93X219103
Parameter	Oxidation Reduction Potential (ORP)	Oxidation Reduction Potential (ORP)	Oxidation Reduction Potential (ORP)	Oxidation Reduction Potential (ORP)	Oxidation Reduction Potential (ORP)
Range	-1000 to 1000 mV	-1000 to 1000 mV	-1000 to 1000 mV	-1000 to 1000 mV	-1000 to 1000 mV
Temp. Range	0 to 80 °C	0 to 80 °C	0 to 80 °C	0 to 80 °C	0 to 100 °C
Sensor Type	Platinum pin	Platinum pin	Platinum pin	Platinum pin	Platinum band
Internal Reference Type	Ag/AgCl	Ag/AgCl	Ag/AgCl	Ag/AgCl	Ag/AgCl
Sealed/Refillable	Sealed	Sealed	Refillable	Refillable	Refillable
Reference Junction	Single	Double	Single	Double	Single
Refilling Reference Electrolyte	–	–	–	–	ECRE001
Dimensions (Shaft)	90 x 12 mm	90 x 12 mm	90 x 12 mm	90 x 12 mm	100 x 12 mm
Cable Length	1 m	1 m	1 m	1 m	1 m
Connector	BNC	BNC	BNC	BNC	BNC
Description	General purpose plastic-body ORP electrode	General purpose plastic-body ORP electrode	General purpose plastic-body ORP electrode. Comes with 10 ml refilling electrolyte	General purpose plastic-body ORP electrode. Comes with 10 ml refilling electrolyte	General purpose glass-body ORP electrode. Comes with 10 ml refilling electrolyte
Used With	All pH meters with BNC input connector	All pH meters with BNC input connector	All pH meters with BNC input connector	All pH meters with BNC input connector	All ORP meters with BNC input connector

## Conductivity Electrodes

Models	CONSEN91B 01X244701	CONSEN91J 01X244721	CONSEN9103J 01X244725	EC620165 93X219046	CONSEN91W 01X244702	CONSEN9501D 01X466602	CONSEN9203J 01X244723	CONSEN9203D 93X219065
Parameter	Conductivity/ Temperature	Conductivity/ Temperature	Conductivity/ Temperature	Conductivity/ Temperature	Conductivity/ Temperature	Conductivity/ Temperature	Conductivity/ Temperature	Conductivity/ Temperature
Range	0 to 150 mS	0 to 150 mS	0 to 150 mS	0 to 500 mS	0 to 150 mS	0 to 150 mS	0 to 350 mS	0 to 350 mS
Temp. Range	0 to 80 °C	0 to 80 °C	0 to 80 °C	0 to 70 °C	0 to 80 °C	0 to 80 °C	0 to 100 °C *	0 to 100 °C *
Cell	2	2	2	4	2	2	4	4
Cell Constant	K = 1.0	K = 1.0	K = 1.0	K = 1.0	K = 1.0	K = 1.0	K = 0.530	K = 0.530
Cell Material	Stainless steel rings, PBT and ultem-body	Stainless steel rings, PBT and ultem-body	Stainless steel rings, PBT and ultem-body	Platinum cell on glass with epoxy-body	Stainless steel rings, PBT and ultem-body	Stainless steel rings, PBT and ultem-body	Graphite with epoxy-body	Graphite with epoxy-body
ATC	Yes	Yes	Yes	Yes	Yes	Yes	Yes	Yes
Dimensions (Shaft)	144 x 16 mm	144 x 16 mm	144 x 16 mm	100 x 12 mm	144 x 16 mm	144 x 16 mm	144 x 16 mm	144 x 16 mm
Cable Length	1 m	1 m	3 m	1 m	1 m	1 m	3 m	3 m
Connector	BNC & phono plug	8-pin	8-pin	8-pin DIN	6-pin	8-pin DIN	8-pin	8-pin DIN
Used With	COND 6+ / TDS 6+ / Salt 6+	COND 610 / COND 600 / CD 650 / PC 650 / PCD 650	COND 610 / COND 600 / CD 650 / PC 650 / PCD 650	CON 1500 / CON 6000 / PC 6000 / PC 6500 / PCD 6500	CON 510 / CON 400 / CON 410 / PC 300 / PC 510 / CON 11 / CON 110	CON 700 / PC 700 / CON 2700 / PC 2700	COND 610 / COND 600 / CD 650 / PC 650 / PCD 650	CON 2700 / PC 2700

\* Max. constant temp of 75 °C; intermittent measurements up to 100 °C













## Dissolved Oxygen (DO) Electrodes













Models	DO6HANDY 01X233913	ECDO6HANDY3M 01X233916	ECDOHANDY8M 01X239606	EC620SSP 01X295704	ECDOHANDYNEW 01X239601
Parameter	% Saturation of Oxygen, Dissolved Oxygen (DO)	% Saturation of Oxygen, Dissolved Oxygen (DO)	% Saturation of Oxygen, Dissolved Oxygen (DO)	% Saturation of Oxygen, Dissolved Oxygen (DO)	% Saturation of Oxygen, Dissolved Oxygen (DO)
Type	Galvanic	Galvanic	Galvanic	BOD amperometric	Galvanic
Range	0 to 20 mg/L	0 to 20 mg/L	0 to 20 mg/L	0 to 20 mg/L	0 to 20 mg/L
Temp. Range	0 to 50 °C	0 to 50 °C	0 to 50 °C	15 to 35 °C	0 to 50 °C
Response Time	1 min to reach 95 % of final reading	1 min to reach 95 % of final reading	40 sec to reach 93 % of final reading	30 sec to reach 90 % of final reading	40 sec to reach 93 % of final reading
Minimum Sample Flow	2 inch / sec	2 inch / sec	2 inch / sec	Self-stirring	2 inch / sec
Maximum Pressure	7.5 bar	7.5 bar	7.5 bar	Lab use only	7.5 bar
ATC	Yes	Yes	Yes	Yes	Yes
Dimensions (Shaft)	78 x 16.5 mm	78 x 16.5 mm	150 x 25 mm	62 x 12 mm	150 x 25 mm
Cable Length	0.9 m	3 m	7.6 m	0.9 m	3 m
Connector	BNC & phono plug	BNC & phono plug	6-pin	8-pin DIN	6-pin
Description	Galvanic Dissolved Oxygen electrode, epoxy body, Noryl cap/HDPE membrane, ATC. Comes with 2 assembled membrane cap housing, 1 refilling electrolyte & 1 scouring pad	Galvanic Dissolved Oxygen electrode, ATC. Comes with 2 assembled membrane cap housing, 1 refilling electrolyte & 1 scouring pad	Galvanic Dissolved Oxygen electrode, ATC. Comes with 1 assembled membrane cap housing, 1 refilling electrolyte & 1 scouring pad	Polarographic Dissolved Oxygen/BOD electrode with self-stirring mechanism	Galvanic Dissolved Oxygen electrode, ATC. Comes with 1 assembled membrane cap housing, 1 refilling electrolyte & 1 scouring pad
Used With	DO 6+ / DO 700	DO 6+ / DO 700	DO 600 / DO 300 / DO 110 / PD 650 / PCD 650	DO 1500 / DO 6000 / PCD 6500 / DO 2700	DO 600 / DO 300 / DO 110 / PD 650 / PCD 650



## Electrodes

### ATC Probes & Temperature Probes

Models	PH5TEM01P	PH5TEMB01P	ECPHWPTM01J	PHWPTEM01W	EC62019	PHWPTEM03J	
	01X021804	01X210303	01X021818	01X021807	01X306504	01X021820	
<b>ATC Probes</b>							
							
	Parameter	Temperature	Temperature	Temperature	Temperature	Temperature	Temperature
	Temp. Range	0 to 100 °C	0 to 100 °C	0 to 100 °C	0 to 100 °C	0 to 100 °C	0 to 100 °C
	Material	Stainless steel 304	Stainless steel 304	Stainless steel 304	Stainless steel 304	Stainless steel 304	Stainless steel 304
	Dimensions (Shaft)	84 x 3 mm	117 x 3 mm	84 x 3 mm	84 x 3 mm	117 x 3 mm	84 x 3 mm
	Dimensions (Handle)	85 x 12 mm	85 x 12 mm	75 x 12 mm	75 x 12 mm	75 x 12 mm	75 x 12 mm
Cable Length	1 m	1 m	1 m	1 m	1 m	3 m	
Connector	2.5 mm phono plug	2.5 mm phono plug	8-pin	6-pin	2.5 mm phono plug	8-pin	
Used With	pH 110 / pH 11 / lon 6+ / pH 6+ / pH 5+	pH 2700 / lon 2700 / pH 2100 / pH 1100 / lon 510 / pH 510 / pH 700 / lon 700	pH 620 / pH 610 / pH 600	pH 310 / pH 300 / PC 300 / PC 510	pH 6500 / pH 6000 / pH 1500 / CON 1500 / PC 6000 / PC 6500 / PCD 6500	PCD 650 / PC 650 / PD 650 / pH 600 / pH 610 / pH 620	

Models	TEM5TEM01P	TEM6TEM01R	ECTGPLPJ01M	ECTGPLPK01M	ECTPPENJ01M	ECTPPENK01M	
	01X021811	01X021814	01X220001	01X220101	01X220002	01X220102	
<b>Temperature Probes</b>							
							
	Parameter	Temperature	Temperature	Temperature	Temperature	Temperature	Temperature
	Range	0 to 125 °C	-50 to 150 °C	-50 to 700 °C	-50 to 700 °C	-50 to 700 °C	-50 to 700 °C
	Meter	Thermistor	RTD	Type J	Type K	Type J	Type K
	Dimensions (Shaft)	117 x 3 mm	117 x 3 mm	200 x 3 mm	200 x 3 mm	120 x 3.2 mm	120 x 3.2 mm
	Cable Length	1 m	1 m	1 m	1 m	1 m	1 m
Connector	¼ inch phono plug	3-pin	Miniature plug	Miniature plug	Miniature plug	Miniature plug	
Description	100 K thermistor Temperature probe, ungrounded, SS304	3 wire RTD Pt 100 Temperature probe, ungrounded, SS304 (max. temp. 150 °C)	General purpose probe (for immersion into liquids), ungrounded	General purpose probe (for immersion into liquids), ungrounded	Penetration probe (for penetrating meat, plastic & semi-soft materials), ungrounded	Penetration probe (for penetrating meat, plastic & semi-soft materials), ungrounded	
Used With	EcoScan Temp 5	EcoScan Temp 6	EcoScan Temp JKT	EcoScan Temp JKT	EcoScan Temp JKT	EcoScan Temp JKT	

Electrode

## Accessories



1. Buffer & Calibration Solutions
2. Soft Carrying Case for Waterproof Testrs
3. Calibration Sachets
4. Buffer Tablets
5. Precision pH Simulator
6. Electrode Stand with Swivel Arm
7. CyberComm 6000 21 CFR Part 11 Application Software
8. USB IrDA Adapter
9. RS232C (LED) Interface Adapter
10. RS232C Microprinters



## Accessories

### Buffer & Calibration Solutions

Buffers and calibration solutions packed in 480 ml durable plastic bottles – economical and convenient for laboratory use. MSDS and COA can be downloaded under “Support” at <http://www.eutechinst.com>

Order Code	Part No.	Description
<b>pH Buffer Solutions (480 ml Per Bottle)</b>		
ECBU1BT	01X211211	pH 1.68 buffer solution
ECBU4BT	01X211201	pH 4.01 buffer solution
ECBU686BT	01X211242	pH 6.86 buffer solution
ECBU7BT	01X211202	pH 7.00 buffer solution
ECBU9BT	01X211222	pH 9.00 buffer solution
ECBU918BT	01X211271	pH 9.18 buffer solution
ECBU10BT	01X211203	pH 10.01 buffer solution
ECBU12BT	01X211212	pH 12.45 buffer solution
ECDPCBT	01X211216	Protein cleaning solution for pH electrode
ECRE005	01X211206	Storage solution for pH electrode
ECRE006	01X370502	Storage solution for 620 series electrode
<b>ORP Solutions (480 ml Per Bottle)</b>		
ECORPPRE	01X081500	Pre-treatment solution (475 mV)
ECORPQUIN	01X062700	Quinhydrone 255 (255 mV, ±15 mV @ 25 °C)
ECORPQUIN086	01X211215	Quinhydrone 86 (86 mV)
<b>Conductivity Standard Solution (480 ml Per Bottle)</b>		
ECCON84BT	01X211241	84 µS/cm KCl calibration solution
ECCON100BT	01X211217	100 µS/cm KCl calibration solution
ECCON500BT	01X211219	500 µS/cm KCl calibration solution
ECCON1413BT	01X211207	1413 µS/cm KCl calibration solution
ECCON2764BT	01X211214	2764 µS/cm KCl calibration solution
ECCON1288BT	01X211210	12.88 mS/cm KCl calibration solution
ECCON1118BT	01X211244	111.8 mS/cm KCl calibration solution
ECCON5000BT	01X211272	5.0 mS/cm KCl calibration solution
<b>TDS 442 Standard Solutions (480 ml Per Bottle)</b>		
EC44250BT	01X109105	50 ppm 442 calibration solution
EC442300BT	01X109102	300 ppm 442 calibration solution
EC4421000BT	01X109104	1000 ppm 442 calibration solution
EC4423000BT	01X109101	3000 ppm 442 calibration solution
<b>Salinity (NaCl) Standard Solutions (480 ml Per Bottle)</b>		
ECNACL5PPT	01X211230	5 ppt NaCl calibration solution
ECNACL25PPT	01X211231	25 ppt NaCl calibration solution
ECNACL45PPT	01X211232	45 ppt NaCl calibration solution
<b>Refilling Reference Electrolytes (480 ml Per Bottle)</b>		
ECRE001	01X211208	Saturated potassium chloride with silver chloride for single junction pH electrodes
ECRE002	01X211218	Saturated potassium chloride for double junction pH electrodes
ECRE003	01X211225	Sodium chloride
ECRE004	01X211243	Ammonium chloride
ECRE015	01X211253	Lithium chloride in ethylene glycerol for organic samples
<b>Storage Solutions (480 ml Per Bottle)</b>		
ECRE005	01X211206	Storage solution for pH electrode
ECRE006	01X370502	Storage solution for EC620130 series pH electrodes
<b>Refilling Solution (60 ml Per Bottle)</b>		
01X099803	01X099803	Refilling solution for double-junction pH electrodes



### Soft Carrying Case for Waterproof Testrs

- Suitable for all Waterproof Testrs and EcoTestrs
- Protect your meter or take it anywhere with handy belt-loop

Order Code	Part No.	Description
ECPOUCH01	56X201300	Belt-loop soft carrying case for testr



## Calibration Sachets (20 x 20 ml Per Box)

Economical NIST-traceable sachets for quick, accurate and convenient calibrations. Simply insert electrode into sachet pack, calibrate, rinse and discard sachet – no separate container needed!

Order Code	Part No.	Description
<b>pH Buffer Sachets (20 x 20 ml Per Box)</b>		
ECBU4BS	01X223102	pH 4.01 buffer sachets (NIST traceable)
ECBU7BS	01X223101	pH 7.00 buffer sachets (NIST traceable)
ECBU10BS	01X223103	pH 10.01 buffer sachets (NIST traceable)
ECRINWT	01X223201	pH deionized water rinse sachets (NIST traceable)
<b>Conductivity/Salinity Sachets (20 x 20 ml Per Box)</b>		
ECCON10BS	01X219905	10 $\mu$ S/cm KCl Conductivity sachets
ECCON447BS	01X219902	447 $\mu$ S/cm KCl Conductivity sachets
ECCON1413BS	01X219901	1413 $\mu$ S/cm KCl Conductivity sachets
ECCON2764BS	01X219903	2764 $\mu$ S/cm KCl Conductivity sachets
ECCON15000BS	01X219904	15000 $\mu$ S/cm KCl Conductivity sachets
ECCON3000BS	01X219906	3000 ppm KCl Salinity calibration sachets



## Buffer Tablets (Box of 100 Tablets) – For Use with Testers Only

These buffer tablets are perfect for small volumes of pH buffers needed for calibration of pocket pH testers. Simply dissolve a tablet in 30 ml of fresh distilled water; calibrates up to  $\pm 0.1$  pH accuracy.

Order Code	Part No.	Description
<b>pH Buffer Tablets (10 Strips x 10 Tablets Per Box)</b>		
ECBU4BX	01X038201	pH 4 buffer tablets
ECBU7BX	01X038202	pH 7 buffer tablets
ECBU10BX	01X038203	pH 10 buffer tablets



## Precision pH Simulator

The Eutech pH-millivolt simulator is a handy, easy-to-use service tool for testing the accuracy of your pH meter. Used for trouble-shooting and fault diagnosis of meters, the simulator works with most pH/redox instruments with BNC connectors. Simulator comes with a BNC cable and a sturdy rubber boot which doubles up as a stand.

- Push button pH/mV selection
- pH accuracy of  $\pm 0.05$ ; mV range of  $\pm 2$
- USA/NIST pH buffer standards simulation
- 16 combination values
- 1 G $\Omega$  high input impedance test
- Large display with bright LED
- Splashproof keypad
- Protective rubber boot doubles up as stand
- Power-saving meter runs on 4 'AAA' x 1.4 V batteries

Order Code	Part No.	Description
ECPHSIMULATOR	01X373301	Precision hi-low impedance and multiple buffer pH simulator (includes 60X030128 BNC-BNC cable)



## Electrode Stand with Swivel Arm

Electrode stand with swivel arm allows convenient hands-free operation. Holds up to four standard size electrodes and one ATC probe.

- Weighted 6-inch diameter base allows you to pivot holder 360° for more flexibility
- Arm allows you to move electrode side to side or up and down while keeping electrode at a constant vertical angle

Order Code	Part No.	Description
ECPHELSTDC	01X081600	Free standing electrode stand with swivel arm
01X321801	01X321801	Electrode arm and bracket for CyberScan 6000, 700 and 2700 series meters





### CyberComm 6000 21 CFR Part 11 Application Software

A powerful, comprehensive data management software designed to expand the functions of your CyberScan 6000 meter, and assist with compliance with FDA's 21 CFR Part 11 regulations. The main window of the CyberComm 6000 looks and works exactly like your meter screen display, so you can work on the computer as you would on the meter.

- Detailed activity log with full audit-trail report generated on demand (accessible by administrator only)
- Manage multiple projects under one ID
- Password security to prevent tampering and accidental data deletions
- Generate comprehensive reports of your project in print-friendly format, or simply translate data into text or Microsoft Excel® format
- Capture snap-shots of your graphs in action while projects are running
- Automatically prints electronic signature with each report print-out generated
- Real-time data-logging and real-time graph, right from the comforts of your computer

Each software CD comes with a software license number to match the serial number of your CyberScan 6000 series meter. Please quote your instrument's serial number when making order.

Order Code	Part No.	Description
ECDAS6000	01X415501	CyberComm 6000 21 CFR Part 11 compliant, CyberScan 6000 series application software



### USB IrDA Adapter

The USB IrDA adapter facilitates data communication between CyberScan 600 handheld meters and computers with no IrDA wireless capabilities.

- Small, light and handy
- No need for separate power source: adapter is powered by connecting PC

Order Code	Part No.	Description
01X447602	01X447602	USB IrDA interface adapter



### RS232C (LED) Interface Adapter

The RS232C adapter receives your data via Infrared signals, allowing your meter to communicate with a PC or microprinter with no infrared facilities.

- Small, light and handy
- No need for separate power source: adapter is powered by connecting PC or printer

Order Code	Part No.	Description
30X427301	30X427301	RS232 cable, for connecting 2700 series to PC, 1.5 m cable
01X344202	01X344202	RS232C (LED) interface adapter



### RS232C Microprinters

The convenience of printing directly from your meter whenever, wherever! This compact dot-matrix microprinter connects easily to your handheld meters via an RS232C outlet – ideal for data-recording and report-generation. Connecting cable included.

- Dot-matrix
- Models with real-time clock and RS232C adapter available

Order Code	Part No.	Description
ECMICROPRNTR01	01X230001	Serial impact microprinter: Dot-matrix, paper-roll portable printer with 25-pin female connector. Includes one roll of paper and a 110/120 VAC power adapter
ECMICROPRNTR02	01X230002	Serial impact microprinter: Dot-matrix, paper-roll portable printer with 25-pin female connector. Includes one roll of paper and a 220/230 VAC power adapter
ECMICROPRNTR02CLK	01X230004	Serial impact microprinter with built-in real time clock: Dot-matrix, paper-roll portable printer with 25-pin female connector. Includes one roll of paper and a 220/230 VAC power adapter
ECADPTRM9M25	09X305002	Adapter for RS232C communication cable: 9-pin male to 25-pin male connector

## Glossary

- **Ag/AgCl** – Silver/silver chloride reference electrode is good for general purpose applications with a wide temperature range of -5 to 110 °C.
- **ATC** or Automatic Temperature Compensation automatically corrects the measured value based on the temperature of the solution (with use of temperature sensor).
- **Auto-Buffer Recognition** identifies and ensures correct pH buffer values are being used during calibration.
- **Auto-CAL** or Automatic Calibration frees users from cumbersome fine adjustment or manual selection of desired standards/buffer values in calibration routine.
- **Auto-Data Logging** allows measured or stored data sets being transferred seamlessly into memory or external peripherals at preset time interval or whenever readings stabilise.
- **Auto-Ranging Capability** scans and switches to the appropriate measurement range.
- **Barometric Pressure Compensation** compensates oxygen solubility for changes in Barometric Pressure.
- **Bi-Directional RS232C Linkup** provides two-way RS232C communication between meter and computer via a cable to remotely control and manage meter operation.
- **BNC** is known as British Naval Connector or Bayonet Nut Connector. This connector is used to join segments of coaxial cable.
- **BOD** – Please refer to page 57 of this catalogue.
- **CAL-Due Prompt** reminds user to calibrate the meter at set regular intervals.
- **CE-Certification** or CE Marking is a conformity marking consisting of the letters "CE". CE is an abbreviation for 'Conformité Européenne', French for 'European Conformity'. The CE Marking indicates that the product it is affixed to conforms to all relevant essential requirements and other applicable provisions that have been imposed upon it by means of European directives, and that the product has been subject to the appropriate conformity assessment procedure(s). For more information, please refer to website at [www.cemarking.net](http://www.cemarking.net)
- **Cell Constant** or  $k$  is the ratio of the distance between the two metal plates and surface area of the two metal plates during measurement.
- **21 CFR Part 11** – A set of criteria set forth by the FDA which qualifies electronic records and signatures to be equivalent in reliability to paper records and handwritten signatures on paper. For more information, please refer to the "Code of Federal Regulations" at [www.fda.gov](http://www.fda.gov).
- **Chlorine** – Please refer to page 86 of this catalogue.
- **Chlorine Dioxide** – Please refer to page 86 of this catalogue.
- **COD** – Please refer to page 57 of this catalogue.
- **Colorimetry** – Please refer to page 86 of this catalogue.
- **Conductivity** – Please refer to page 36 of this catalogue.
- ▼ **Cyanuric Acid** – Please refer to page 86 of this catalogue.
- ▼ **DAS** or Data Acquisition Software connects the bench meter using a RS232C communications cable and can be used to control the meter from a PC. This software is available with the benchtop series 1100/2100, 1500 and 6000. The software also provides Data Acquisition functions and allows data from the meter to be captured and stored for processing on a PC. Other features of the software are the ability to zoom in to certain areas of the graph, set the length of time to capture data, set meter settings like temperature units, pH and mV alarm limits, calibration reminders, resolution and many other parameters. Updated versions are available on the website [www.eutechinst.com](http://www.eutechinst.com)
- ▼ **DIN** or Deutsches Institut für Normung eV is a German national organization for standardization. A DIN buffer set usually refers to the 1.09, 3.06, 4.65, 6.79, 9.23, and 12.75 pH. Selected Eutech meters such as the CyberScan pH 310 is capable of up to 6 points of calibration if the DIN buffer standard is chosen. A DIN connector is a connector that conforms to one of the many standards defined by DIN. Eutech meters that feature the DIN connector include the CyberScan bench series 1500 and 6000.
- ▼ **DPD Method** is US EPA accepted for reporting drinking water analyses (Free and Total Chlorine) and wastewater analyses (Total Chlorine only). Please refer to the "Standard methods for the Examination of Water and Wastewater" and US EPA method 330.5 for wastewater and Standard Method 4500-Cl G for drinking water for more information.
- ▼ **DO** or Dissolved Oxygen – Please refer to page 56 of this catalogue.
- ▼ **Double-Junction Protection** in electrodes is necessary to prevent electrode poisoning. Reference junction poisoning is inevitable especially in cases where there is sulphide content in the sample. Sulphide is known to attack silver in the reference and shorten the electrode's useful life. With the double junction protection, the 'poison' takes longer to reach the reference junction hence extending the electrode's useful life. The new range of large display waterproof pocket testers feature double junction electrodes for long lasting performance. Please refer to page 16, 100 and 101 of this catalogue.
- ▼ **Electrode Diagnosis** provides useful information on electrode condition and characteristics after each calibration.
- ▼ **EMC** or Electromagnetic Compliance is one of the CE Directives specified for electrical products. All Eutech products with CE-certification adhere to the EMC Directive. For more information, please refer to [www.cemarking.net](http://www.cemarking.net)
- ▼ **EPA** or Environmental Protection Agency leads the environmental science, research, education and assessment efforts in the US. For more information, please visit [www.epa.gov](http://www.epa.gov)
- ▼ **Formazin Standards** – Formazin was first established by the US Environmental Protection Agency (See EPA) as a Turbidity standard in 1926. However, its importance as a standard has been relegated due to its many shortcomings, one of which being that one of the chemicals which formazin is derived from, hydrazine sulphate, is carcinogenic. Eutech's Turbidity meters use a safe, non-toxic, non-carcinogenic alternative to formazin standards which can be used for calibration directly without mixing or dilution.
- ▼ **Galvanic Cell** – Please refer to page 56 of this catalogue.
- ▼ **GLP** or Good Laboratory Practices refers to regulations that are observed to ensure high quality experimental standards and reliable data.
- ▼ **HVAC** stands for Heating, Ventilation and Air Conditioning System.
- ▼ **HCl** is the chemical formulation of Hydrogen Chloride that is a highly corrosive and toxic colorless gas that forms white fumes on contact with humidity. These fumes consist of hydrochloric acid which forms when hydrogen chloride dissolves in water. Hydrogen chloride gases as well as hydrochloric acid are important chemicals in chemistry, science, technology, and industry. A 0.1 M HCl can be prepared as a 1% pepsin solution to break down any protein deposits on an electrode. For more information on electrode cleansing, please refer to page 103 of this catalogue.
- ▼ **IP** stands for 'Ingress Protection'. An IP number is used to specify the environmental protection of enclosures around electronic equipment. These ratings are determined by specific tests. The IP number is composed of two numbers, the first referring to the protection against solid objects and the second against liquids. The higher the number, the better the protection. Eutech products such as the CyberScan waterproof series and waterproof testers have IP67 housing. The first digit '6' indicates total protection against dust and second digit '7' protects against the effects of immersion between 15 cm and 1 m.
- ▼ **IrDA Communications** – IrDA stands for Infrared Data Association, a group of manufacturers who developed a standard for transferring data via infrared light waves; a secure wireless link that allows the meter to be connected to a computer or printer without the help of cables.
- ▼ **ISO 7027** is the water quality standard measured in terms of Turbidity determined by the International Organisation for Standardisation. For more information on ISO, please refer to the website [www.iso.org](http://www.iso.org) Eutech Turbidimeters TN 100 and TB 1000 (infrared light source models) comply with the ISO 7027 standards.
- ▼ **kPa** or Kilopascal refers to a unit of pressure. 1 kPa is approximately the pressure exerted by a 10-g mass resting on a 1-cm<sup>2</sup> area. 101.3 kPa = 1 atm. There are 1000 pascals in 1 kilopascal.
- ▼ **KCl** refers to the Chemical Compound Potassium Chloride which is a metal halide composed of potassium and chlorine. KCl is used in medicine, scientific applications and food processing. A heated diluted KCl can be used to unclog a reference junction. For more information on electrode cleansing, please refer to page 103 of this catalogue.
- ▼ **LSD** or Least Significant Digit refers to the right-most active digit of a digital display.
- ▼ **MTC** or Manual Temperature Compensation is an alternative method for temperature compensation through the manual input of sample temperature value. ATC is more practical in most applications.
- ▼ **Multiple-Point Calibration** ensures the highest accuracy across the full measurement range.
- ▼ **NIST** or National Institute of Standards and Technology is a non-regulatory agency of the United States Department of Commerce's Technology Administration. The institute's mission is to develop and promote measurement, standards, and technology to enhance productivity, facilitate trade, and improve the quality of life. The NIST buffer standards usually refer to pH 1.68, 4.01, 6.86, 9.18, and 12.45. For more information, please visit [www.nist.gov](http://www.nist.gov)



- ▼ **NTU** or Nephelometric Units is the preferred expression of Turbidity. For more information on Turbidity, please refer to page 86 of this catalogue.
- ▼ **Non-Volatile Memory** retains stored data and calibration information indefinitely even if power is disconnected.
- ▼ **Normalisation Temperature** is used to standardise measurements to a known ambient temperature value (generally at 20 °C or 25 °C).
- ▼ **Open Pore pH Electrode** makes use of a single pore capillary reference junction that is about 200\* times larger than a typical ceramic junction. (\*With reference to Eutech open pore electrodes EC620130, EC620131, EC620132 and EC620133.) This unique construction protects the electrode from clogging even in difficult samples. If used in combination with specially formulated electrolyte, the flow rate into the pore is faster and leads to better contact between the reference electrode and sample. This generates a shorter response time and more accurate measurements. For more information, please refer to page 102 of this catalogue.
- ▼ **ORP** or Oxidation Reduction Potential – Please refer to page 15 of this catalogue.
- ▼ **OUR** or Oxygen Uptake Rate values are given in mg/L/hr and is usually applicable in the study of the concentration of micro-organisms.
- ▼ **Ozone** – Please refer to page 86 of this catalogue.
- ▼ **Polarographic Cell** – Please refer to page 56 of this catalogue.
- ▼ **pH** – Please refer to page 14 of this catalogue.
- ▼ **pH Slope** – Please refer to page 14 of this catalogue.
- ▼ **PWB** or Pure Water Buffer refers to water with low ionic concentration.
- ▼ **Replatinising** is necessary when the platinum-black layer of the Conductivity sensor wears off over time. The Conductivity section of the sensor consists of two platinum plates or wires that are plated with a layer of “platinum-black”. Usually this is a relatively soft layer and is required for stable, accurate measurements. In time, the platinum-black layer may wear off in some applications and the sensor will require replatinising.
- ▼ **Resistivity** – A measure of how strongly a material opposes the flow of electric current. A low Resistivity indicates a material that readily allows the movement of electrical current charge.
- ▼ **RJ45** or Registered Jack 45 is a physical interface often used for terminating twisted pair type cables. “RJ” stands for Registered Jack which is part of the United States Code of Federal Regulations. It has eight “pins” or electrical connections per connector. Common uses include internet and Ethernet cables. The CyberScan Series 6000 offers RJ45 connector for internet and Ethernet communication capabilities to conduct on-the-spot online research and access global email account.
- ▼ **RS232C** – RS232C stands for Recommended Standard-232, A TIA/EIA standard for serial transmission between computers and peripheral devices (modem, mouse, etc.). Using a 25-pin DB-25 or 9-pin DB-9 connector, its normal cable limitation of 50 feet can be extended to several hundred feet with high-quality cable.
- ▼ **RTD** – Please refer to page 92 of this catalogue.
- ▼ **Salinity** – Please refer to page 56 of this catalogue.
- ▼ **Salinity Correction** compensates the variations in oxygen solubility due to salt concentration in the sample.
- ▼ **Self-Diagnostic Messages** prompt and guide users with error message codes or graphical icons for easy meter troubleshooting.
- ▼ **Soft Keys** – Soft keys are located close to the screen-readouts that display the functions selected when the keys are pressed; commonly used on small devices with limited space such as handphones, PDAs and handheld meters.
- ▼ **SOUR** or Specific Oxygen Uptake Rate indicates biological activity of microbes in the wastewater treatment process and the load placed on them. SOUR is the relationship between oxygen uptake and the amount of solids. SOUR values are given in mg/hr/g.
- ▼ **Stability Function** averages and displays indicator or icon whenever readings stabilise.
- ▼ **TDS** or Total Dissolved Solids – Please refer to page 36 of this catalogue.
- ▼ **TDS Conversion Factor** is a factor for converting Conductivity to TDS value to best suit the specific sample being measured (e.g. KCl = 0.5, 442 = 0.67 @ 25 °C).
- ▼ **Temperature Coefficient** indicates the temperature influence in the chemical equilibrium (eg disassociation) of the solution due to non-linearity of intrinsic salt/chemical property varies from one sample to another (typically 2.1 %/°C at 25 °C).
- ▼ **Temperature Compensation** is necessary as most electrochemical parameters (i.e. pH, Conductivity, DO) are temperature dependent and most applications require some form of temperature compensation to ensure standardized measured values. Please refer to the definitions for ATC and MTC on page 113.
- ▼ **Thermistor** – Please refer to page 92 of this catalogue.
- ▼ **Thermocouple** – Please refer to page 92 of this catalogue.
- ▼ **Thermometry** – Please refer to page 92 of this catalogue.
- ▼ **Turbidity** – Please refer to page 86 of this catalogue.
- ▼ **USEPA Method 180.1** – A regulatory method set by US EPA which requires the following to be included in the design of Turbidity meters: 1. Primary detector for nephelometric (90 degree) measurement; 2. Light source tungsten filament lamp (white light); 3. Spectral response peak for the detector between 400 and 600 nm, the primary wavelengths of light.

**Warranty**

Eutech Instruments warrants its instruments to be free from manufacturing defects as follows: pocket testers for 2 years, handheld and bench meters for 3 years, and electrodes/sensors for 6 months (unless otherwise specified).

**Certification**

All Eutech products are CE-certified to comply with global standards for electromagnetic emission and interference.

**Disclaimers**

Specifications and terms are subject to change. Not all products are available in all countries. Please consult your local sales representative for details.

**Trademarks Used:**

*pHTestr<sup>®</sup>, TDSTestr<sup>®</sup>, ORPTestr<sup>®</sup> and SaltTestr<sup>®</sup> are registered trademarks of Cole-Parmer Instrument Co., an associate company of Eutech Instruments.*

*Windows<sup>®</sup> is a registered trademark of Microsoft Corporation in the United States and other countries.*

*Kynar<sup>®</sup> is a registered trademark of Arkema Inc.*

*Valox<sup>®</sup> is a registered trademark of General Electric Company (G.E.)*

### Over 15 Years of Product Excellence

Eutech Instruments is a leading ISO9001-certified company established in 1990. Dedicated to the design and manufacture of sensor-based instruments for water quality analysis, Eutech is a pioneer in the development of ASIC-based (Application Specific Integrated Circuit) instruments, and is internationally recognised for its achievements in sensor technology, software programming and product design. Eutech has an extensive product line, which includes the world's first Windows® CE-driven colour touchscreen research-grade bench meter, as well as instruments with proprietary patents and trademarks.

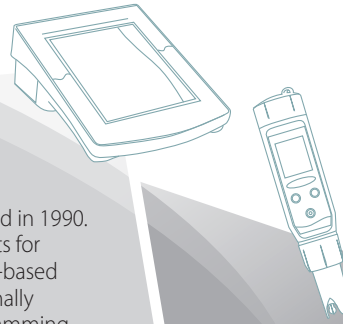

### Commitment to R&D

Eutech's competitiveness comes from our strong commitment to R&D. This is backed by a dedicated team of scientists and engineers which thrives on meeting new technological challenges to simplify laboratory and field analytical procedures. The Eutech team is constantly driven to explore the latest technologies and applying them in our design and manufacture of advanced instruments. The result is a unique line of products that are accurate, consistent, reliable and easy to use.

### Forging New Frontiers in Water Analysis

Underlying Eutech's objective to be a world leader in the field of water analysis instrumentation, the company adopts a proactive stand in anticipating the needs of the industry. With increasing global awareness and concern for water quality, the future provides new and exciting challenges and opportunities. To realize the potential of advanced water analytical technologies, Eutech will continue to forge close links and strategic alliances with research institutions, government agencies and private sector firms worldwide. These efforts support the Eutech mission – to make advanced technology easy to use.

### Comprehensive Product Line

Eutech's constant drive for innovation is reason for our unique and expansive portfolio of microprocessor-based instruments and chemical sensor systems. We offer a comprehensive range of laboratory and field instruments for electrochemical and photometric water analysis. Eutech also manufactures continuous on-line process instruments for the monitoring and control of pH, Conductivity, Total Dissolved Solids (TDS), Redox Potential (ORP), Dissolved Oxygen (DO) and other water quality parameters.

Eutech products range from compact pocket testers and handheld meters to research-grade benchtop meters and industrial process controllers. Each product carries the signature Eutech intuitive design and is packed with advanced user-friendly features.

### Global Reach

Eutech products are marketed in over seventy countries worldwide, through an extensive network of associate companies and distributors, with manufacturing facilities in Singapore and Malaysia. Eutech Instruments Singapore has a full-fledged value-chain operation which comprises R&D, manufacturing, marketing, customer service and logistics for worldwide support to customers.

### Customer Focus

Every Eutech innovation is conceptualised with the user in mind. This, coupled with our strategic location in the design and technology hub of Asia, has enabled the company to produce cutting edge instruments at competitive prices. Our consistent demonstration of insight into customer needs and product demands has earned the company consecutive Frost & Sullivan Market Engineering awards for Product Line Strategy.

Driven by a successful Total Customer Satisfaction Program incorporated in the ISO9001:2000 Quality System, all products undergo extensive testing and calibration by a qualified team of technical experts. Stringent quality control measures guarantee consistency, durability and performance. Eutech products are certified to comply with various global testing standards.

### Thermo Fisher Scientific

Eutech is part of Thermo Fisher Scientific.

Thermo Fisher Scientific Inc. (NYSE: TMO) is the world leader in serving science, enabling our customers to make the world healthier, cleaner and safer. With an annual revenue rate of more than \$10.5 billion, we employ 34,000 people and serve over 350,000 customers within pharmaceutical and biotech companies, hospitals and clinical diagnostic labs, universities, research institutions and government agencies, as well as environmental and industrial process control settings.

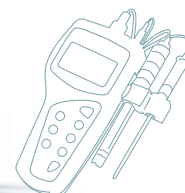
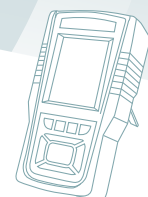

water analysis made easy



## World-Wide Support

Eutech provides world-wide sales and service support for all its products through in-country offices and its network of independent channels in over 70 countries worldwide. Contact Eutech for details of your nearest channel partner.

Visit our website at [www.eutechinst.com](http://www.eutechinst.com) for the latest updates on new products, technical tips, download of MSDS and COA, as well as free software updates.



## Global Offices

### Asia Pacific (Head Office) | Eutech Instruments Pte Ltd

Blk 55, Ayer Rajah Crescent, #04-16/24, Singapore 139949  
Tel: (65) 6778-6876 • Fax: (65) 6773-0836  
Email: [eutech@thermofisher.com](mailto:eutech@thermofisher.com) • Website: [www.eutechinst.com](http://www.eutechinst.com)

### North & South America | OAKTON Instruments

625 E Bunker Ct, Vernon Hills, IL 60061, USA  
Tel: toll free 1-888-4OAKTON (1-888-462-5866) • Fax: (1) 847-247-2984  
Email: [info@4oakton.com](mailto:info@4oakton.com) • Website: [www.4oakton.com](http://www.4oakton.com)

### Europe | Eutech Instruments Europe B.V.

P.O. Box 254, 3860 AG Nijkerk, The Netherlands  
Wallerstraat 125K, 3862 CN Nijkerk, The Netherlands  
Tel: (31) 033-2463887 • Fax: (31) 033-2460832  
Email: [eutech@thermofisher.com](mailto:eutech@thermofisher.com) • Website: [www.eutech.nl](http://www.eutech.nl)

### Malaysia | Eutech Instruments Sdn Bhd

No. 1, Lengkok Keluli 2, Bukit Raja Prime Industrial Park,  
41050 Bukit Raja, Klang Selangor D.E., Malaysia  
Tel: (603) 3342-8533 • Fax: (603) 3342-6520  
Email: [eutech@thermofisher.com](mailto:eutech@thermofisher.com) • Website: [www.eutechinst.com](http://www.eutechinst.com)

### China | Thermo Fisher Scientific

Building 6, No. 27, Xin Jinqiao Road,  
Shanghai 201206, China  
Tel: (86) 21-6865-4588 • Fax (86) 21-6445-7909  
Email: [eutech@thermofisher.com](mailto:eutech@thermofisher.com) • Website: [www.eutech.cn](http://www.eutech.cn)

### India | Thermo Fisher Scientific

Plot no. C - 327, TTC Industrial Area, Pawane,  
Navi Mumbai 400 705, India  
Tel: (91) 22-4175 8800 / 4175 8888 • Fax: (91) 22-4175 8801  
Email: [eutech@thermofisher.com](mailto:eutech@thermofisher.com) • Website: [www.eutechinst.com](http://www.eutechinst.com)

**EUTECH**  
**INSTRUMENTS**  
*Technology Made Easy ...*

Part of Thermo Fisher Scientific



ISO 9001  
QMS-SM Global  
#0042905



SINGAPORE 1000  
SINGAPORE SME 500  
2006 & 2007



Awarded in 2001 & 2003

Distributed by:

[www.eutechinst.com](http://www.eutechinst.com) | [eutech@thermofisher.com](mailto:eutech@thermofisher.com)

Singapore • USA • Netherlands • Malaysia • China • India