

PosiTector 200

INSTRUCTION MANUAL v. 2.0

Ultrasonic Coating Thickness Gage

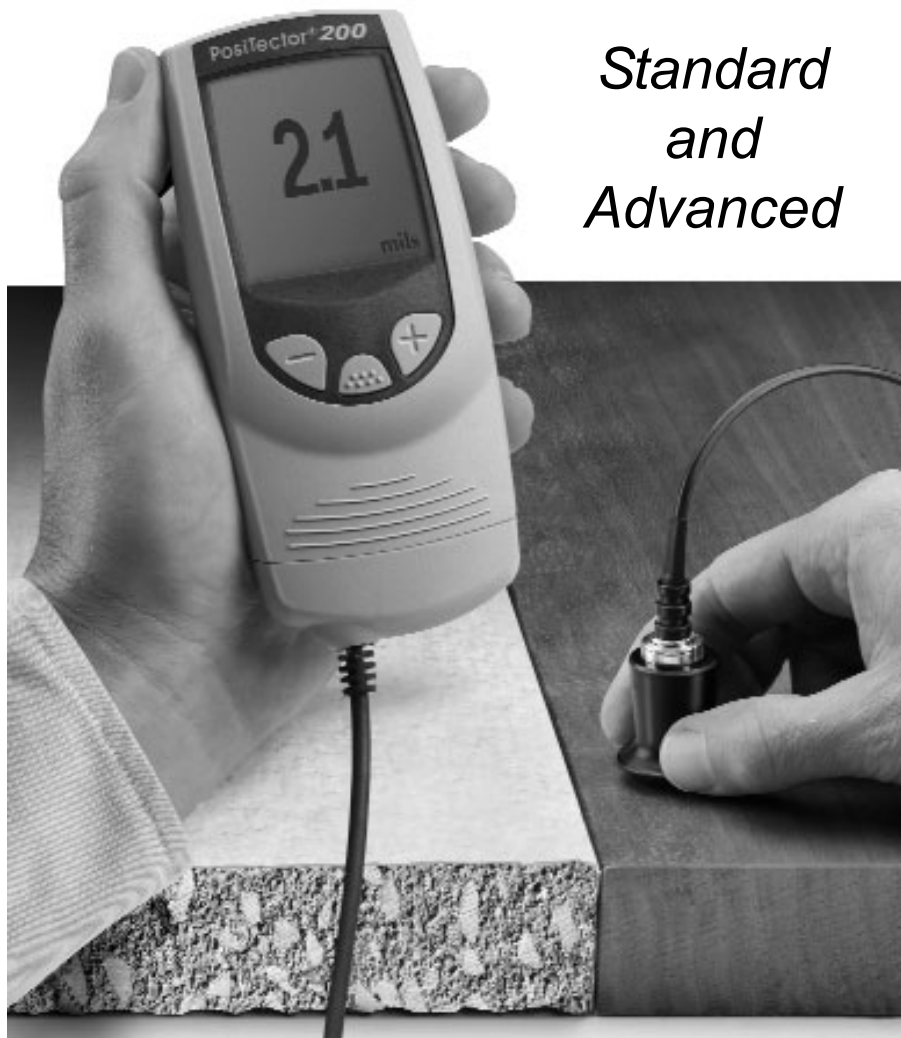

*Standard
and
Advanced*

DeFelsko®

Simple. Durable. Accurate.

TQC
WWW.TQC.EU

TQC bv
Nijverheidscentrum 14
2761 JP Zevenhuizen
The Netherlands

T +31 180 631344
F +31 180 632917
E info@tqc.eu
W www.tqc.eu

Introduction

The **PosiTector 200** is a hand-held Coating Thickness Gage that uses a non-destructive ultrasonic principle to measure coating thickness on a wide variety of substrates.

The **PosiTector 200** probe emits a high frequency sound pulse that travels into the coating via a couplant and reflects from ANY surface that is different in density. Coating thickness readings are obtained by measuring the time taken for the ultrasonic signal to propagate from the probe to the coating/substrate interface and back. The travel time is divided by two and multiplied by the velocity of sound in the coating to obtain the thickness of the coating.

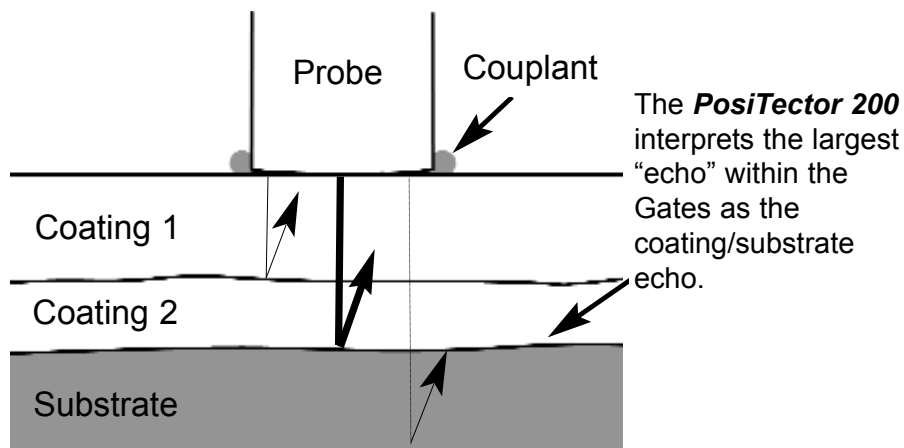

NOTE: Throughout this manual, the **W** symbol indicates more information about the particular topic or feature is available on our website.

Go to: www.defelsko.com/manuals

Power-up / Power-down

The **PosiTector 200** powers-up when any button is pressed. To preserve battery life, the Gage powers-down after approximately 3 minutes of no activity. All settings are retained.

Certification

All probes or gages are shipped with a Certificate of Calibration. For organizations with re-certification requirements, gages may be returned at regular intervals for calibration. DeFelsko recommends that customers establish gage calibration intervals based upon their own experience and work environment. Based on our product knowledge, data and customer feedback, a one year calibration interval from either the date of calibration, date of purchase, or date of receipt is a typical starting point.

Operation Overview

1. Turn the Gage **ON** (see Power-Up pg.2)
2. **ZERO** the probe (see pg.5)
3. **ADJUST** to a known thickness, if necessary (see pg.8)
4. **MEASURE** the part (see pg.5)

Typical Display:

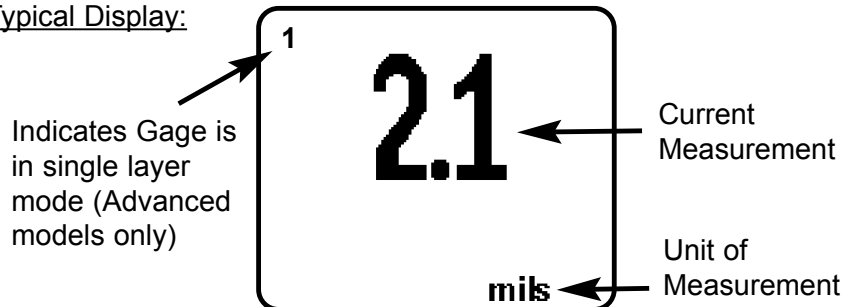



Couplant

Couplant is required to propagate ultrasound into the coating. Water is a good couplant for smooth coatings. Use the supplied glycol gel for rougher coatings. While it is unlikely that the couplant will damage the finish or leave a stain on the surface, we suggest testing the surface by using the couplant on a sample. If testing indicates that staining has occurred, a small amount of water can be used instead of couplant. Consult the Material Safety Data Sheet available on our website and your coating supplier if you suspect the couplant may damage the coating. Other liquids such as liquid soap may also be used.

Menu Operation

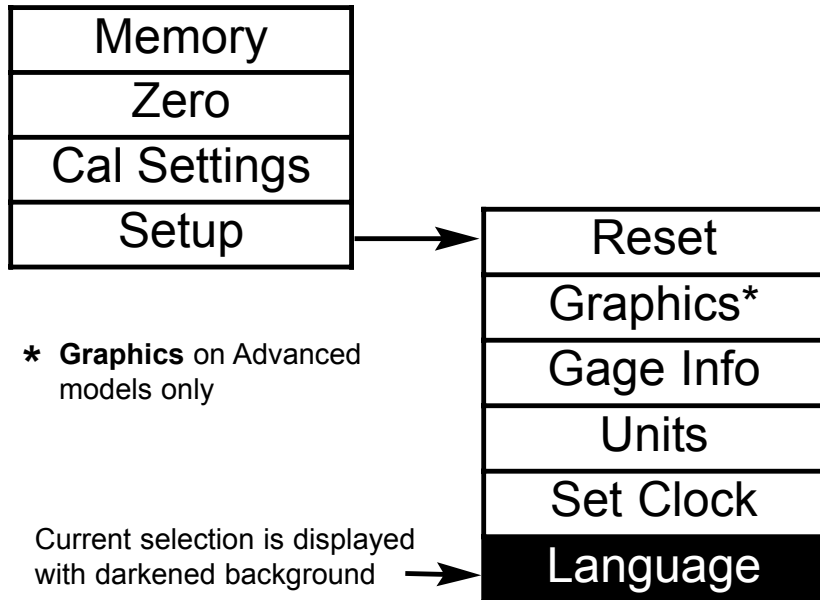
Gage functions are menu controlled. To access the Menu, turn the Gage on, then press the  button.



To navigate, press (-) to scroll DOWN, (+) to scroll UP and  to SELECT. Press both (-)(+) buttons at any time to exit any menu or select Exit from the Menu.

List boxes have a down arrow on the right-hand side. Use the (-) and (+) buttons until your desired choice appears, then press  to select this choice and move focus onto the next item.

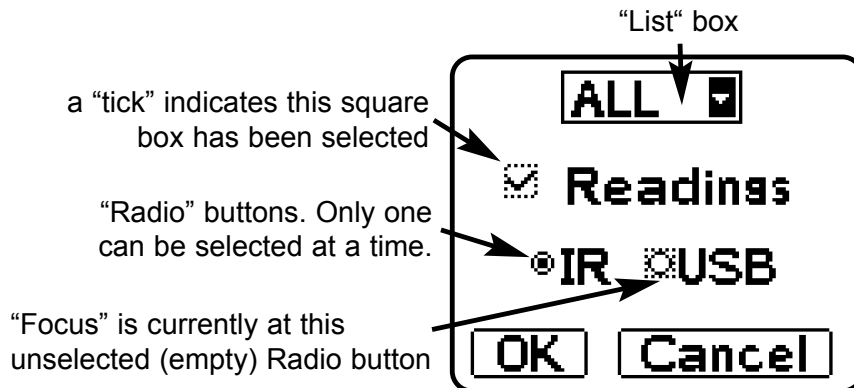

How to Measure

1. Apply couplant to the surface of your part.
2. After power-up, place the probe FLAT on the surface and press down.
3. Lift the probe when you hear a double BEEP or see the green indicator light blink. Measurement result is displayed on the LCD.



A second reading may be taken at the same spot by continuing to hold the probe down on the surface.

4. When completely finished, wipe the probe clean of couplant then return both Gage and probe to the protective case. There is no need to disconnect the probe from the Gage during storage.

Zero Menu Option

Zero

The probe must be periodically zeroed using the ZERO menu option to compensate for both extreme temperature and probe wear effects. Before using, allow the probe to reach ambient temperature. Wipe the probe clean of couplant.

If measurements will be made in extreme hot or cold temperatures, it is recommended to ZERO the probe in the working environment.

If measurements will be made on rough substrates, it is recommended to periodically ZERO the probe to compensate for wear.

Set Gates Option

Set Gates

Each probe has a measuring range as shown on page 19. For example the **C probe** can measure coatings in the range of 50 to 3800 microns (2 to 150 mils).

Gates are used to narrow the range of thickness that the Gage examines. **Gate A** sets the minimum thickness limit and **Gate B** the maximum.

Standard Model

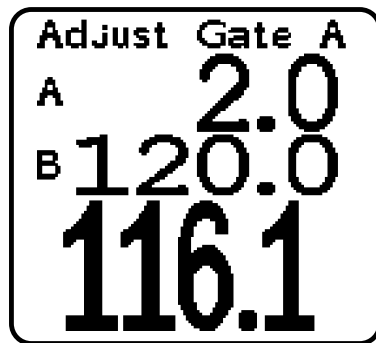

Advanced Model

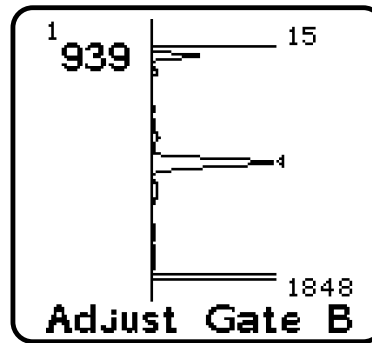





For most applications the default Gate values do not have to be adjusted. But some conditions may exist in the user's application that cause the Gage to display very low or non-repeatable readings. These conditions include...

- rough or textured coatings
- hard (dense) coatings
- coatings applied in multiple layers
- coatings applied on a very thin, hard substrate

Important: When measuring, the Gage finds the most distinct interface within the two Gate settings. If the coating thickness is outside this range, incorrect or dashed readings may occur. The **PosiTector 200** interprets the largest "echo" or echoes within the gates as the coating/substrate echo.

To make adjustments:

1. Measure the coated part.
2. Select the **Set Gates** menu option.
3. Gate **A** can be changed first. Adjust the value down (-) or up (+).
Press  to accept the value and to move to Gate **B**.
4. Gate **B** can now be changed. Adjust the value down (-) or up (+).
5. Press  to accept the value. Standard models will exit.
6. Advanced models will display a Cursor which allows analysis of the peaks displayed in the Graph. Adjust the Cursor down (-) or up (+). 
Press  to accept Gate values and exit.

NOTE:

Use the Cursor to measure multi-layer coating systems with more than 3 distinct layers.

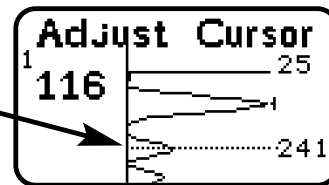

Here are some typical Gate settings...

<u>Expected paint thickness</u>	<u>Gate A</u>	<u>Gate B</u>
500µm (20 mils) on concrete	130µm (5 mils)	1000µm (40 mils)
50µm (2 mils) on wood	25µm (1 mil)	250µm (10 mils)



NOTE: The displayed thickness reading may change when Gate values are adjusted. The new thickness value represents the distance to the "loudest" interface within the new A/B Gate values (see pg.2). This handy feature makes it easy to ignore other measurements such as surface roughness.

For additional help with Gates see Application Notes (pg.15)

Adjust Thickness Option

Adj Thickness

Select a reference standard of material as close as possible in composition to the intended application. For best results, the thickness of the reference standard should be equal to or slightly greater than the thickness of the coating to be measured.

1. Apply a drop of couplant onto the reference standard.
2. Measure the reference standard.
3. Lift the probe. Select the Adj Thickness menu option.
4. Adjust the display down (-) or up (+) to the reference standard thickness.
5. Press  to store the adjustment. Standard models will exit.
6. Advanced models with more than 1 layer selected will continue to the next layer. Adjust the thickness (step 4) and store the adjustment by pressing . When all layers have been adjusted, the gage will exit the Adj Thickness option.

Note: A Reset (pg.11) will restore factory settings.

Memory Mode

Memory

The **PosiTector 200** can record 10,000 measurements in up to 1000 groups (batches) for on-screen statistical purposes, for printing to an optional IR printer, or for downloading to a personal computer using optional **PosiSoft** software and USB cable.

New Batch

-closes any currently opened batch and creates a new batch name using the next higher number. For example, if only Batch 1 and Batch 3 exist, then Batch 4 would be created and made the current batch. Statistics are displayed and each measurement will now be simultaneously shown on the display and stored into this new batch. On screen statistics are immediately updated with each measurement. New batch names are date stamped at the time they are created.

Shortcut: When a batch is open, create a new batch by pressing (+)

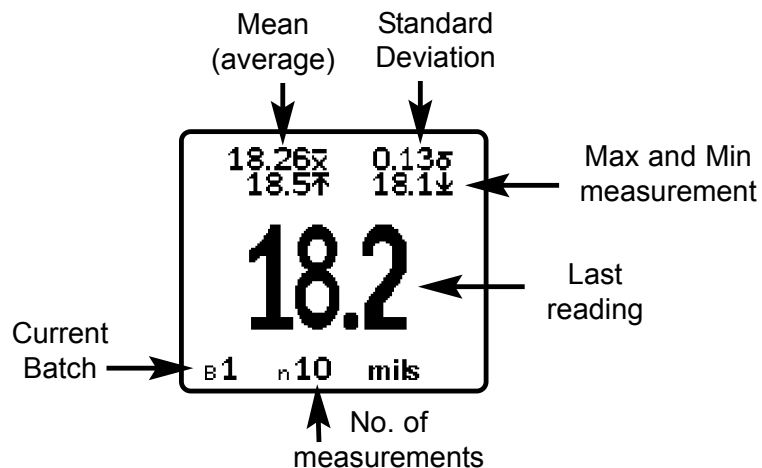

Open

-selects a previously created batch name to open and make current. If it contains measurements, on-screen statistics will immediately reflect values calculated from this batch.

Close

-stops the recording process, closes the current batch, and removes the statistics from the display.

Delete

-removes a batch completely from memory. The name is deleted and all measurements are erased.

View

-lists all readings on the display from the current or most recently used batch. It begins by showing the last 10 measurement values. Scroll using the (-) or (+) buttons. Hold for 1 second to scroll a page at a time.

To change or delete a value, scroll to that value (align the “+” symbol beside it) then either take another measurement to change it, or press  to delete it or exit. Statistics are updated.

Print

-prints all stored measurements to the optional IR printer or to a PC's default Windows printer via the optional USB cable and PosiSoft software. Press (-)(+) simultaneously to cancel printing.

NOTE:

Remove the last reading from the current open batch by pressing (-).

Downloading Measurements Stored in Memory
Measurements stored in the Gage's memory (in batches) can be downloaded to a computer using optional PosiSoft software and USB cable. Measurements are not erased from memory after downloading.

PosiSoft® allows entry of notes and annotations, prints histograms and basic charts, manages data, and readings can be exported to a document or spreadsheet. 

Setup Menu

Setup

Reset

Reset restores factory settings and returns the Gage to a known, out-of-the-box condition. It is handy when you want to “start all over”

The following occurs:

- all batches are closed and stored measurements are erased.
- calibration adjustments are cleared and returned to the Gage’s factory calibration settings.
- Gates are returned to default settings.
- menu setting are returned to the following:
 - Memory = OFF
 - Graphics = OFF (Advanced models only)

A more thorough Reset can be performed by holding the (+) button when the Gage is powered down until the Reset symbol appears. It performs the same function as a menu Reset with addition of Units = microns, and Language = English.

Graphics

Advanced models only

The right hand side of the screen can be used to display a graphical representation of the ultrasonic pulse as it passes through the coating system.

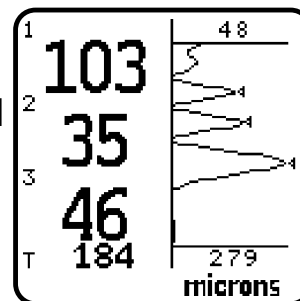

Shortcut: Press the (+) to toggle Graphics On/Off (shortcut is active when Memory is off)

As the probe is depressed and the ultrasonic pulse travels through the coating system, the pulse encounters changes in density at the interfaces

between coating layers and between the coating and the substrate.

These interfaces are depicted by a "peak". The greater the change in density the higher the peak. The more gradual the change in density, the greater the width of the peak. For example, two coatings layers made of essentially the same material and "blended" would result in a low, wide peak. Two materials of very different density and a well-defined interface would result in a high, narrow peak.

The **PosiTector 200** Advanced chooses the highest of peaks when trying to determine coating layer thickness. For example, if the number of layers is set to 3, the 3 highest peaks between the A & B Gates are selected as the interfaces between these layers. The peaks that the Gage selected are indicated by black triangle arrows.

The top (A) and bottom (B) Gate values (pg.6) are displayed as two horizontal lines at the top and bottom of the graphics area. Their current values are shown to the right of each line. Gate A, the minimum limit, is at the top. Gate B, the maximum limit, is at the bottom. Echoes or peaks (thickness values) outside these Gates are ignored. Gate values are set and modified using the Set Gates menu option.

This Graphics display can be manipulated with the Set Gates menu option. In addition to being able to adjust the Gate values, a Cursor can be positioned anywhere between the two Gate values to investigate other peaks.

Units

This menu button converts the display and all stored readings from mils to microns or vice versa.

Set Clock

All batches are *date*-stamped when created, and all measurements are *time*-stamped (24 hour format) when stored into these batches. It is therefore important to keep both the date and time current using this menu button. Alternatively, the date and time can be automatically updated when the gage is connected to **PosiSoft** using the Gage Utilities -> Set Clock function in **PosiSoft**.

Measuring Multiple Layers

Layers

Advanced models only

Advanced models of the **PosiTector 200** are capable of numerically displaying up to 3 individual layer thicknesses in a multi-layer system.

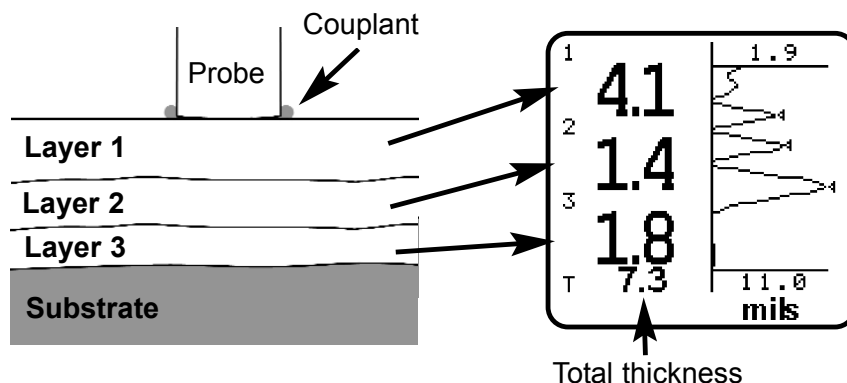

To setup the Gage for multi-layer coatings:

1. Select Layers from the Cal Settings menu.
2. Select the number of layers using the (-) and (+) buttons.
Press  to accept the value.

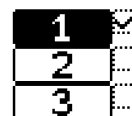

NOTE:

Before setting up the Gage for multi-layer measurement, it is recommended that you first take measurements in single layer mode and interpret the results using the Graphics option (see pg.11)



Available Options

A variety of accessories are available to help you get the most from your **PosiTector 200** coating thickness gage. (W)

Calibration, Verification and Adjustment

Three steps ensure best accuracy...

1. **Calibration** - typically done by the manufacturer or a qualified lab
2. **Verification** of Accuracy - as done by the user
3. **Adjustment** - to a known thickness

Calibration

Calibration is the controlled and documented process of measuring traceable calibration standards and verifying that the results are within the stated accuracy of the Gage. Calibrations are typically performed by the Gage manufacturer or by a certified calibration laboratory in a controlled environment using a documented process. (W)

Verification

Verification is an accuracy check performed by the user using known reference standards. A successful verification requires the Gage to read within the combined accuracy of the Gage and the reference standards. (W)

Adjustment

Adjustment, or *Calibration Adjustment*, is the act of aligning the Gage's thickness readings to match that of a known reference sample in order to improve the accuracy of the gage on a specific coating. (pg.8)

The **PosiTector 200** is factory calibrated. But in order for it to take accurate thickness measurements of a particular material it might be necessary to adjust the gage for that material. To determine if an adjustment is necessary for your application, measure a sample of known thickness of the coating material to be measured. If the average of a series of measurements is not close to the expected thickness, adjust to the expected thickness. Samples should be flat, smooth and as thick or thicker than the maximum expected thickness of the piece to be tested.

Application Notes

The **PosiTector 200** uses an ultrasonic principle to measure coating thickness of most coatings on most substrates. An ultrasonic signal is a very high frequency sound wave. Like the echoes you hear when you shout in a large hall or canyon the **PosiTector 200** listens for echoes from acoustic boundaries within your application.

The **PosiTector 200** probe emits a high frequency sound pulse that travels into the coating via a coupling gel and reflects from ANY surface that is different in density. Coating thickness readings are obtained by measuring the time taken for the ultrasonic signal to propagate from the probe to the coating/substrate interface and back. The travel time is divided by two and multiplied by the velocity of sound in the coating to obtain the thickness of the coating. The strength of the reflected signal from the coating/substrate interface determines the ability of the instrument to measure the thickness of the coating. Since most applications are not homogeneous the gage will "hear" many echoes when placed on a coating/substrate. The instrument "hears" ALL reflections within the measurement

limits of the gage and assumes the largest “echo” is the coating/substrate echo (single coating applications only). Adjustable measurement Gates have been provided for the user to force the instrument to ignore echoes from unwanted boundaries within the sample. Several examples below help to illustrate the use of Gates for specific applications.

Measurement of coatings with rough surfaces.

When rough coatings are measured, the gage typically identifies the thickness from the top of the coating peaks down to the substrate (#1). Couplant fills the voids between the probe and the coating (#2) creating an additional interface. If echoes from the couplant/coating interface (#2) are stronger than the coating/substrate interface (#1), an adjustment (increase) of Gate **A** may be required for the gage to display the weaker (#1) echo.

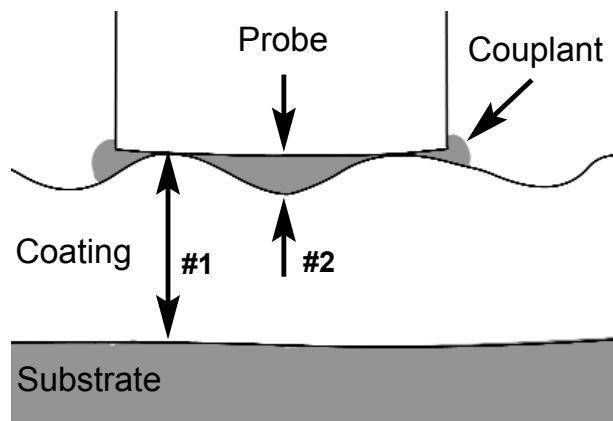

Measurement of dense (hard) coatings.

A significant echo occurs at the probe/coating interface. The relative strength of this echo compared to the coating/substrate echo requires that Gate **A** be increased.

Measurement of total thickness in multi-layer coating applications.

Multiple coating/coating/substrate interfaces may generate several echoes. The user may need to adjust Gates to ignore echoes from coating/coating interfaces. (W)

Troubleshooting

Gage does not turn on

Make sure the + and - battery terminals are positioned properly and that fresh Alkaline batteries are being used.

Gage powers up but fails to stay on

Replace batteries with fresh Alkaline batteries. If problem persists return Gage for service.

Gage readings are much lower than expected

Gage may be measuring surface roughness. Raise the value of Gate **A**. See pg.6

Gage readings are much higher than expected

Gage may be measuring both the coating and substrate. Lower the value of Gate **B**. See pg.6

Gage does not yield accurate or consistent results



See the Set Gates (pg.6) and Adjustment (pg.8) sections to ensure the gage has been optimized for your application. Check the Gage on traceable standards.

Gage displays an error message while attempting probe ZERO

Make sure to hold the probe in the air and ensure the probe is free of couplant. If problem persists, note the error message and contact our technical support department.



Changing The Batteries

The battery icon  displays a full bar with fresh alkaline batteries installed. As the batteries weaken, the bar will be reduced. When the battery icon is low , the Gage can still be used, but the batteries should be changed at the earliest opportunity. USE ONLY "AAA" ALKALINE BATTERIES. Nickel-cadmium and nickel-metal hydride rechargeable batteries will work but the Gage may appear to have weak batteries.

To retain all user settings and stored memory readings, only replace the batteries after the Gage has automatically powered-down.

Returning for Service

Before returning the Gage for service...

1. Install new Alkaline batteries in the proper alignment as shown within battery compartment.
2. Examine the probe tip for dirt or damage.
3. Perform a Reset (pg.11) and a Zero (pg.5)
4. Place a plastic shim onto a hard surface (i.e. glass) and attempt a measurement. (see pg.5)

If you must return the Gage for service, describe the problem fully and include measurement results, if any. Be sure to also include the gage, probe, your company name, company contact, telephone number and fax number or email address.

Website: www.defelsko.com/support

Technical Data

Conforms to: ASTM D6132 and ISO 2808

Gage body dimensions:

(146 x 64 x 31 mm) 5.75" x 2.5" x 1.2"

Temperature Range: 0 to 40°C (+32° to +104°F)

Probe	Measuring Range*
<i>B</i>	13 - 1000 microns (0.5 - 40 mils)
<i>C</i>	50 - 3800 microns (2 - 150 mils)

*Range limits apply to polymer coatings only. 

Accuracy: \pm (2 microns + 3% of reading)
 \pm (0.1 mils + 3% of reading)

Warranty

DeFelsko fully warrants its products against defects in workmanship or materials under normal use for a period of two years from date of purchase. In the event that an instrument is believed to be defective, return the product with proof of purchase to your dealer. If upon DeFelsko's inspection of the instrument, it is determined in our sole discretion that the returned instrument is defective as to workmanship or material, the instrument will be repaired or replaced at DeFelsko's sole option.

In no event shall DeFelsko be liable for any indirect, special, incidental or consequential damages.

The warranty is voided if the Instrument has been opened.

Data subject to change without notice.



TQC bv
Nijverheidscentrum 14
2761 JP Zevenhuizen
The Netherlands

T +31 180 631344
F +31 180 632917
E info@tqc.eu
W www.tqc.eu



The Measure of Quality

www.defelsko.com

© DeFelsko Corporation USA 2006
All Rights Reserved

This manual is copyrighted with all rights reserved and may not be reproduced or transmitted, in whole or part, by any means, without written permission from DeFelsko Corporation.

DeFelsko, PosiTector and PosiSoft are trademarks of DeFelsko Corporation registered in the U.S. and in other countries. Other brand or product names are trademarks or registered trademarks of their respective holders.

Every effort has been made to ensure that the information in this manual is accurate. DeFelsko is not responsible for printing or clerical errors.