



WATER QUALITY ANALYZERS

SENSOR TECHNOLOGY



- pH
- mV(ORP)
- ION
- Conductivity
- DO
- Resistivity
- Salinity
- TDS



<http://www.horiba-water.com/>

ELECTRODE LINE UP



HORIBA popular ToupH electrode is now even tougher and responds faster

ToupH

Enhanced stability and minimized drift

Integrating two new technologies for faster response times and optimal performance

01 pH fast response glass membrane (Patent pending)

New Technology

The membrane contains HORIBA's unique combination of rare earth metals to improve response time by twofold and to increase durability against chemical substances.

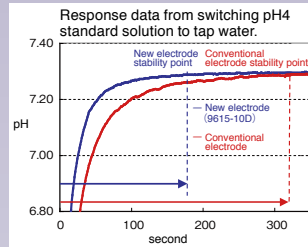

02 Reference electrode with increased stability (Patent pending)

New Technology

Covering the internal electrode with a cation-conductive hollow fiber membrane, liquid junction clogging by silver ions and silver complex ions is reduced to 1/1000 of the conventional technology. Furthermore, maintained internal solution concentration ensures a stable standard electrical potential.

ToupH electrodes are now even stronger

HORIBA's glass membrane molding technology achieves strengths more than 10 times the Japanese Industrial Standards (strength tests).



New dome-shaped construction boosts strength in all directions !



NEW pH

NEW

Pb Free

water proof

NEW

Pb Free

water proof

STANDARD ToupH
9615-10D

SLEEVE ToupH
9681-10D



General laboratory application

Buffer adjustment, general measurement



High viscosity application

Non-aqueous water, protein sample, food, and drinks

ToupH

pH (3-in-1)

Plastic Electrode
9625-10D



Sleeve
6367-10D



For Food Analysis
6252-10D



pH (Combination)

Standard
6066-10C



For Extra-Thin Test Tubes
6069-10C



Needle Type
6251-10C



Flat Type
6261-10C



ORP

Metallic Electrode
Platinum
3-in-1 Type
9300-10D



Temperature

Temperature Electrode
4163-10T



Conductivity

Immersion Type
3551-10D



Immersion Type
3552-10D



Immersion Type
3553-10D



Immersion Type
9382-10D



Flow Type
3561-10D



Flow Type
3562-10D



Flow Type
3573-10C



Flow Type
3574-10C



Dissolved Oxygen

Field Use
9551-20D
(2 m Cable)



Field Use
9551-100D
(10 m Cable)



Laboratory Use
9520-10D



Not just “unbreakable”.
New flat sensor innovations allow the measurement of trace sample droplets or the measurement of solid sample surface.

What is an ISFET (semiconductor sensor) ?

ISFET is the abbreviation of Ion Sensitive Field Effect Transistor. The response membrane is equipped with semiconductor based sensor.

1. Will not crack or break like conventional glass electrodes
2. The sensor is flat and very small in size, enabling the measurement of extremely small samples
3. Easy handling and maintenance - simply clean with a toothbrush
4. Can be stored dry

Special features of the ISFET

The flat electrode has less than a 100µm distance between the housing and the sensor

The unique structure enables to measure miniscule amount of moisture on the surface of solid objects and prevents bubbles from trapping on the sensor when measuring samples in a beaker.

Effects of static electricity is reduced

The combination of HORIBA’s unique semiconductor device construction and improved static protection circuit means that the effects of static electricity, once the Achilles heel of semiconductor sensors, are greatly reduced.

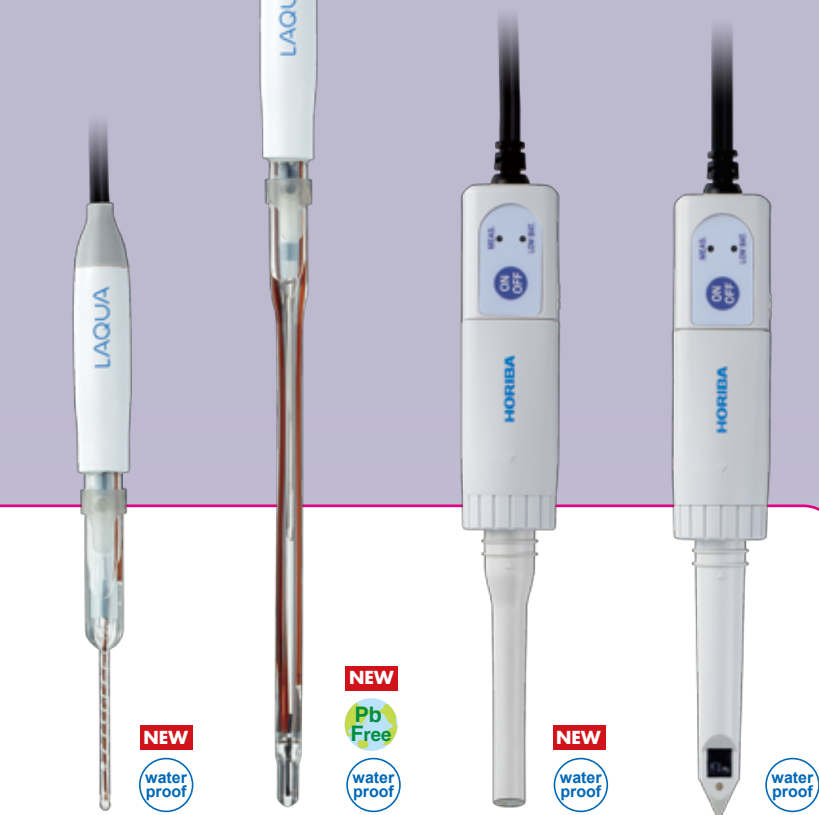
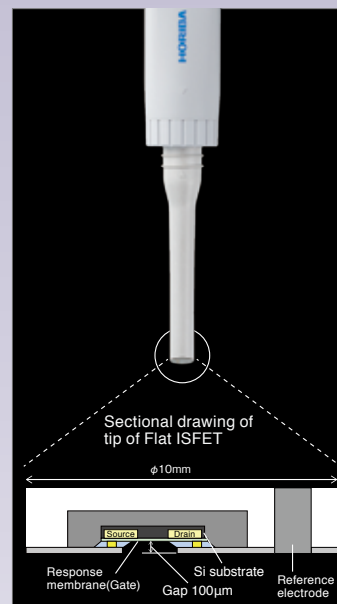

MICRO ToupH 9618-10D **LONG** ToupH 9680-10D **FLAT** ISFET 0040-10D **NEEDLE** ISFET 0030-10D



Precious, trace amount sample
Direct measurement from micro tubes, only 50µL of sample required

For large containers and long test tubes
283 mm length & 8 mm diameter

Surface of solid samples
Gel-like materials such as agar medium, foods such as meat, cloth and paper surface

Inside solid samples
Measurement inside the solid sample such as fruits, vegetables and bread

ISFET

ION

Cyanide Ion Electrode 8001-10C CN ⁻	Chloride Ion Electrode (Combination Type) 6560-10C Cl ⁻	Chloride Ion Electrode 8002-10C Cl ⁻	Sulfide Ion Electrode 8003-10C S ²⁻	Iodide Ion Electrode 8004-10C I ⁻	Bromide Ion Electrode 8005-10C Br ⁻	Copper Ion Electrode 8006-10C Cu ²⁺	Cadmium Ion Electrode 8007-10C Cd ²⁺	Lead Ion Electrode 8008-10C Pb ²⁺	Thiocyanate Ion Electrode 8009-10C SCN ⁻	Fluoride Ion Electrode (Combination Type) 6561-10C F ⁻
Fluoride Ion Electrode 8010-10C F ⁻	Silver Ion Electrode 8011-10C Ag ⁺	Ammonia Electrode (Combination Type) 5002A-10C NH ₃	Sodium Ion Electrode 1512A-10C Na ⁺	Nitrate Ion Electrode (Combination Type) 6581-10C NO ₃ ⁻	Nitrate Ion Electrode 8201-10C NO ₃ ⁻	Potassium Ion Electrode (Combination Type) 6582-10C K ⁺	Potassium Ion Electrode 8202-10C K ⁺	Calcium Ion Electrode (Combination Type) 6583-10C Ca ²⁺	Calcium Ion Electrode 8203-10C Ca ²⁺	

LABORATORY

LAQUA

F-70 Series DS-70 Series

pH

mV(ORP)

ION

Conductivity

Resistivity

Salinity

TDS



Intuitive and very easy
to use touch panel operation

Simply slide your finger across the screen to switch displays



2-channel can be
displayed simultaneously



Color LCD display

NAVI 2CH USB
PC PRT ID
USP/EP/JP

F-74
CH.1 pH ORP ION
CH.2 COND RESI SAL TDS

NAVI 2CH USB
PC PRT ID
USP/EP/JP

F-73
CH.1 pH ORP ION
CH.2 pH ORP ION

NAVI 2CH USB
PC PRT ID
USP/EP/JP

F-72
CH.1 pH ORP ION

NAVI USB PC PRT
ID USP/EP/JP

DS-72
COND RESI SAL TDS

Full support for on-screen settings confirmation, maintenance information and troubleshooting tips guide you through trouble free operation

Inspection Navigation

Easy navigation for main unit and electrode inspections.

Various industrial standards (JIS, USP, EP, JP, CP) are also supported.

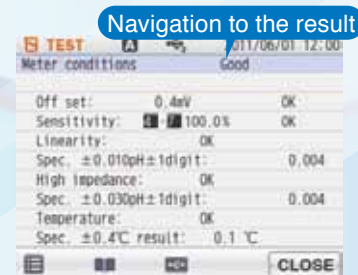
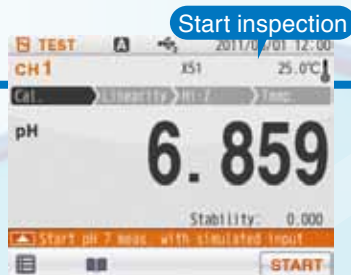

Troubleshooting Navigation

On-screen reliable support for a resolution when a problem occurs during calibration or sample measurements. A user's guide is incorporated in the software to access if one experiences any operation difficulties.

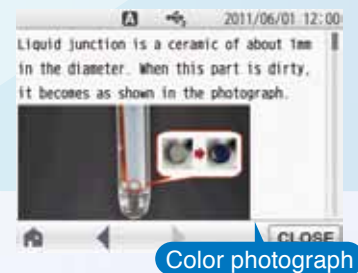
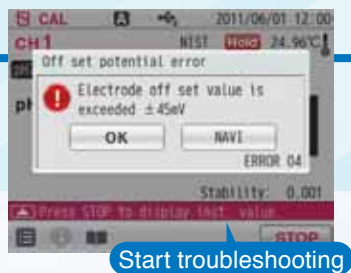

Application Functions

Various industry standard methods are supported from the measurement to result output.

Conductivity measurement for various country pharmaceutical pure water guidelines are also supported.

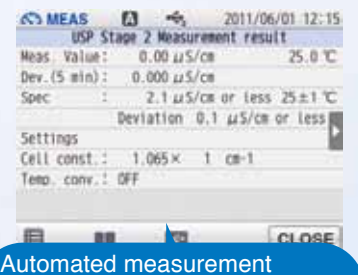
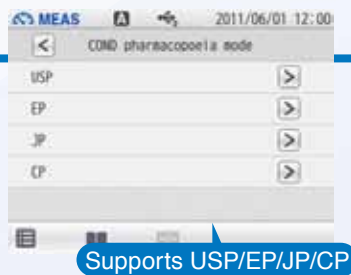

Full-Range of Functions for Validation and Usability

- Periodic inspection mode: JIS/Pharmacopeias/Digital Simulator (F-72/F-73/F-74)
- Full support for various country pharmaceutical pure water guidelines (USP/EP/JP/CP) (F-74/DS-72)
- Customizable auto hold function for calibration and measurement (F-72/F-73/F-74/DS-72)
- Simultaneous connection to a GLP/GMP compatible printer and PC
- Digital memory: Maximum 2,000 sets of measurement data can be recorded (F-71/F-74BW/DS-71:999)
- USB PC Communication *(All models) and USB memory (F-72/F-73/F-74/DS-72)
- Multi-language support (Japanese, English, Chinese, Korean) (F-72/F-73/F-74/DS-72)
- FDA21CFR Part 11 (Please ask for quotation)

Custom LCD display

NAVI 2CH USB
PC PRT ID
USP/EP/JP

F-74BW
CH.1 pH ORP ION
CH.2 COND RESI SAL TDS

NAVI 2CH USB
PC PRT ID
USP/EP/JP

F-71
CH.1 pH ORP

PC PRT ID

DS-71
COND RESI SAL TDS

Option



Printer
(For GLP/GMP compliance)
Printer Cable
Part No. 3014030148
(9096003800)



Digital Simulator
(For GLP/GMP compliance)
X-51 (pH, ORP, ION, DO, TEMP)
X-52 (COND, TEMP)

- NAVI Navigation function
- 2CH 2-channel measurement
- USB USB flash drive compatible
- PC PC connection* compatible (USB)
- PRT Printer output compatible (printer sold separately)
- ID Security function
- USP/EP/JP Conductivity measurements stipulated under various countries*

* Data storage software available as a free download for registered users.

Economical meter
for pH and
temperature



D-51

pH

Multi-parameter for
pH/temperature/ORP
with PC/printer output
capability.



D-52

pH ORP

• RS-232C output (PC/Printer)

Multi-parameter for
pH/temperature/ORP/ION
with PC/printer output
capability



D-53

pH ORP ION

• RS-232C output (PC/Printer)

FIELD

navi^h

D-50 Series

ES-51

OM-51



pH

mV(ORP)

ION

Conductivity

DO

Resistivity

Salinity

Multi-parameter for pH/temperature/ORP/ conductivity with PC/printer output capability



D-54

pH **ORP** **COND**

• RS-232C output (PC/Printer)

Multi-parameter for pH/temperature/ORP/ dissolved oxygen with PC/printer output capability



D-55

pH **ORP** **DO**

• RS-232C output (PC/Printer)

Portable conductivity/resistivity/ salinity meter with PC/printer output



ES-51

COND **SAL** **RESI**

• RS-232C output (PC/Printer)

*Set includes conductivity electrode. (model 9382-10D)

Portable dissolved oxygen meter with PC/printer output



OM-51

DO

• RS-232C output (PC/Printer)

*Select from the followings.
 • 2 m cable (OM-51-2)
 • 10 m cable (OM-51-10)
 • Laboratory (OM-51-L1) (BOD measurement)

Revolutionary waterproof meter and electrodes enhance care-free operation in the lab or field

HORIBA portable meter conforms to waterproof standard of IEC529:IP67.



pH electrode (model 9621-10D) is waterproof down to depth of 1m.

DO electrode (model 9551-20D, 9551-100D) is waterproof down to depth of 10m.

Quick connection to PC allows easy and fast data evaluation



Portable multi-parameter meter allows measurement of up to 4 parameters

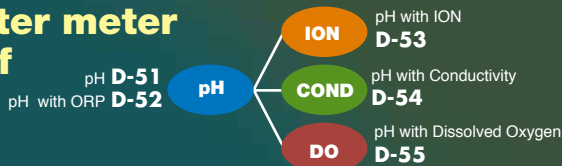

Automatic data-logging function

Store up to 300 sets of data automatically.

Self diagnostic function assures reliable measurement

User-friendly self-diagnostic modes for battery voltage, temperature, calibration and LCD checks.

User-friendly features and portability with large LCD display



■ Option



Digital Simulator

X-51(pH, ORP, ION, DO,TEMP)

X-52(COND,TEMP)



Electrode Stand

Part No. 3014028590(9096002700)



■ F-70 series / DS-70 series Specifications

		F-71 CH.1 pH ORP	F-72 CH.1 pH ORP ION	F-73 CH.1 pH ORP ION CH.2 pH ORP ION	F-74 CH.1 pH ORP ION CH.2 COND RESI SAL TDS	F-74BW CH.1 pH ORP ION CH.2 COND RESI SAL TDS
Measurement method	pH	Glass electrode method				
	ION	Ion electrode method				
	Conductivity	2 AC bipolar method				
	Salinity	Conversion from conductivity value				
	Resistivity	Conversion from conductivity value				
	TDS	Conversion from conductivity value				
Measurement range	pH	pH0.000 ~ 14.000 Resolution 0.001pH	pH0.000 ~ 14.000 Resolution 0.01/0.001pH			pH0.000 ~ 14.000 Resolution 0.001pH
	mV(ORP)	±1999.9mV Resolution 0.1mV				
	Temperature(Display)	0.0 ~ 100.0°C(-30.0 ~ 130.0°C) Resolution 0.1°C				
	ION	0.00µg/L ~ 999g/L(mol/L) Resolution Valid numbers 3 digits				
	Conductivity	Cell constant 100m ⁻¹ : 0.000mS/m ~ 19.99S/m Cell constant 10m ⁻¹ : 0.0µS/m ~ 1.999S/m Cell constant 1000m ⁻¹ : 0.00mS/m ~ 199.9S/m Resolution 0.05% of F.S.				
	Salinity	0.00 ~ 80.00PPT(0.000%~8.000%) Resolution 0.01PPT(0.001%)				
	Resistivity	Cell constant 100m ⁻¹ : 0.00Ω · m ~ 199.9kΩ · m Cell constant 10m ⁻¹ : 0.0Ω · m ~ 1.999MΩ · m Cell constant 1000m ⁻¹ : 0.000Ω · m ~ 19.99kΩ · m Resolution 0.05% of F.S.				
	TDS	0.01 mg/L ~ 1000 g/L Resolution 0.01mg/L			0.01 mg/L ~ 100 g/L Resolution 0.01mg/L	
Repeatability	pH	±0.005pH±1digit	±0.001pH±1digit			±0.005pH±1digit
	mV(ORP)	±0.1mV±1digit				
	Temperature	±0.1°C±1digit				
	ION	±0.5% ±1 digit of F.S.				
	Conductivity	±0.5% ±1 digit of F.S.				
	Resistivity	±0.5% ±1 digit of F.S.				
Memory		999sets	2000sets	2000sets	2000sets	999sets
Multilanguage display		Japanese/English/Chinese/Korean				
Power		AC adaptor 100 ~ 240V 50/60Hz				
Power consumption		Approx. 0.7VA	Approx. 9.8VA			Approx. 0.7VA
Mass of main unit		Approx. 500g	Approx. 700g			Approx. 500g
Accessories included		Electrode stand Manual/AC adapter	Electrode stand/Manual/AC adapter/Cover			Electrode stand Manual/AC adapter



■ D-50 series / ES-51 / OM-51 Specifications

		D-51 pH	D-52 pH ORP •RS-232C output (PC/Printer)	D-53 pH ORP ION •RS-232C output (PC/Printer)	D-54 pH ORP COND •RS-232C output (PC/Printer)	D-55 pH ORP DO •RS-232C output (PC/Printer)	ES-51 COND SAL RESI •RS-232C output (PC/Printer)
Measurement method	pH	Glass electrode method					
	ION	Ion electrode method					
	Conductivity	AC bipolar method					
	Dissolved Oxygen	Diaphragm galvanic battery method					
	SALT	Conductivity conversion					
	Resistance	Conductivity conversion					
	Saturation Oxygen	Conductivity conversion					
	Oxygen	Conductivity conversion					
Measurement range	pH	pH0.00 ~ 14.00 Resolution 0.01pH	pH0.00 ~ 14.00 Resolution 0.01pH	pH0.00 ~ 14.00 Resolution 0.01pH	pH0.00 ~ 14.00 Resolution 0.01pH	pH0.00 ~ 14.00 Resolution 0.01pH	
	Temperature	0.0 ~ 100.0°C Resolution 0.1°C					
	mV(ORP)	-1999 ~ 1999 Resolution 1mV					
	ION	0.0µ ~ 999g/L (mol/L)					
	Conductivity	Cell constant 100m ⁻¹ : 0.000mS/m ~ 19.99S/m Cell constant 10m ⁻¹ : 0.0µS/m ~ 1.999S/m Cell constant 1000m ⁻¹ : 0.00mS/m ~ 199.9S/m Resolution 0.05% F.S.					
	Dissolved Oxygen	0.00 ~ 19.99mg/L Resolution 0.01mg/L					
	Resistance	Cell constant 100m ⁻¹ : 5.00Ω·m ~ 199.9kΩ·m Cell constant 10m ⁻¹ : 50.0Ω·m ~ 1.99MΩ·m Cell constant 1000m ⁻¹ : 0.500Ω·m ~ 19.99kΩ·m Resolution 0.05% F.S.					
	SALT	0.00 ~ 4.00% Resolution 0.01%					
	Saturation Oxygen	Conductivity conversion					
	Oxygen	Conductivity conversion					
Repeatability	pH	±0.01pH ±1digit	±0.01pH ±1digit	±0.01pH ±1digit	±0.01pH ±1digit	±0.01pH ±1digit	
	Temperature	±0.1°C ±1digit					
	mV(ORP)	±1mV ±1digi					
	ION	±0.5%F.S. ±1digit					
	Conductivity	±0.5%F.S. ±1digit					
	Dissolved Oxygen	±0.1mg/L ±1digit					
	Resistance	±0.5%F.S. ±1digit					
Power supply		DC3V (LR6 dry cell battery) Option: AC adapter	DC3V (LR6 dry cell battery) Option: AC adapter	DC3V (LR6 dry cell battery) Option: AC adapter	DC3V (LR6 dry cell battery) Option: AC adapter	DC3V (LR6 dry cell battery) Option: AC adapter	DC3V (LR6 dry cell battery) Option: AC adapter
Mass		Approx. 300g	Approx. 300g	Approx. 330g	Approx. 330g	Approx. 330g	Approx. 300g

pH/ORP Electrode Line up

DS-71		DS-72	
COND	RESI	SAL	TDS
COND	RESI	SAL	TDS
2 AC bipolar method			
Conversion from conductivity value			
Conversion from conductivity value			
Conversion from conductivity value			
0.0 ~ 100.0°C(-30.0 ~ 130.0°C) Resolution 0.1°C			
Cell constant 100m ⁻¹ : 0.000mS/m ~ 19.99S/m Cell constant 10m ⁻¹ : 0.0μS/m ~ 1.999S/m Cell constant 1000m ⁻¹ : 0.00mS/m ~ 199.9S/m Resolution 0.05% of F.S.			
0.00~80.00PPT(0.000%~8.000%) Resolution 0.01PPT(0.001%)			
Cell constant 100m ⁻¹ : 0.00Ω · m ~ 199.9kΩ · m Cell constant 10m ⁻¹ : 0.0Ω · m ~ 1.999MΩ · m Cell constant 1000m ⁻¹ : 0.000Ω · m ~ 19.99kΩ · m Resolution 0.05% of F.S.			
0.01 mg/L ~ 100 g/L Resolution 0.01mg/L	0.01 mg/L ~ 1000 g/L Resolution 0.01mg/L		
±0.1°C ±1digit			
±0.5% ±1 digit of F.S.			
±0.5% ±1 digit of F.S.			
999sets	2000sets		
AC adaptor 100 ~ 240V 50/60Hz			
Approx. 0.7VA	Approx. 9.8VA		
Approx. 500g	Approx. 700g		
Electrode stand Manual/AC adapter	Electrode stand/Manual /AC adapter/Cover		

Name	Description	Model	Temp.range(°C)	pH range	Part No. (Old No.)	
Combination pH electrode	3-in-1	Plastic body	9625-10D	0~100 *1	0~14	3200360505
		Standard ToupH	9615-10D	0~100	0~14	3200366539
		Micro ToupH	9618-10D	0~60	0~14	3200366552
		Long ToupH	9680-10D	0~100 *1	0~14	3200366560
		Sleeve ToupH	9681-10D	0~60	0~14	3200366572
		Sleeve	6367-10D	0~60	0~14	3014079136(9003011800)
		For measurement of low-conductivity water and non-aqueous solvents	6377-10D	0~60	0~14	3014093085(9003014100)
		Needle type	6252-10D	0~60	0~12	3014080850(9003013800)
		For very slender test tubes	6069-10C	0~60	0~14	3014081107(9003013500)
		Flat type	6261-10C	0~50	0~12	3014081807(9003013700)
ISFET pH electrode	Flat type ISFET	0040-10D	0~60	0~14	3200367925	
	Needle type ISFET	0030-10D	0~60	0~14	3014028323(9096002100)	
	Flat type ISFET(0040-10D) sensor	141	0~60	0~14	3200367926	
	Needle type ISFET(0030-10D) sensor	131	0~60	0~14	3014028400(9096002200)	
Temperature electrode	For temperature compensation and measurement	4163-10T	0~100	—	3014080375(9003013000)	
ORP electrode	Water proof Platinum 3-in-1 type	9300-10D	0~60	—	3014046710(9096000400)	

*1 Do not use this electrode with other electrodes, as it will interfere the measurement value.

Conductivity Electrode Line up

Electrode	Cell constant m ⁻¹ (cm ⁻¹)	Model	Range m ⁻¹ (cm ⁻¹)	Minimum Volume	Temp. range(°C)	Part No. (Old No.)	
Conductivity electrode	Immersion type	10 (0.1)	3551-10D	10μS ~ 1S (0.1μS ~ 10mS)	50mL	0 ~ 60	3014081712(9056000800)
		100 (1)	9382-10D	0.1mS ~ 10S (1μS ~ 100mS)	20 ~ 30mL	0 ~ 80	3014046709(9096000300)
		100 (1)	3552-10D	0.1mS ~ 10S (1μS ~ 100mS)	15mL	0 ~ 100	3014081545(9056000900)
		1000 (10)	3553-10D	1mS ~ 100S (10μS ~ 1S)	50mL	0 ~ 60	3014081714(9056001000)
		10 (0.1)	3561-10D	10μS ~ 1S (0.1μS ~ 10mS)	10mL	0 ~ 60	3014082350(9056001100)
	Flow type	100 (1)	3562-10D	0.1mS ~ 10S (1μS ~ 100mS)	16mL	0 ~ 60	3014082513(9056001200)
		1000 (10)	3573-10C	1mS ~ 100S (10μS ~ 1S)	4mL	0 ~ 60	3014082590(9056001300)
		1000 (10)	3574-10C	1mS ~ 10S (10μS ~ 100mS)	0.25mL	0 ~ 60	3014082592(9056001400)

Ion Electrode Line up

Please be aware of the hindering ion and pH range interference of ion electrodes.

Electrode name	Model	Measuring range	Applicable reference electrode	Part No. (Old No.)
Cyanide ion electrode	8001-10C	0.03 ~ 2,600 ppmCN ⁻	2060A · 2565A	3014094393(9003015500)
Chloride ion electrode (Combination type)*	6560-10C	0.4 ~ 35,000 ppmCl ⁻	—	3014093430(9003014500)
Chloride ion electrode	8002-10C	0.4 ~ 35,000 ppmCl ⁻	2565A	3014094394(9003015600)
Sulfide ion electrode	8003-10C	0.3 ~ 32,000 ppmS ²⁻	2060A · 2565A	3014094395(9003015700)
Iodide ion electrode	8004-10C	0.01 ~ 13,000 ppmI ⁻	2060A · 2565A	3014094396(9003015800)
Bromide ion electrode	8005-10C	0.8 ~ 80,000 ppmBr ⁻	2565A	3014094397(9003015900)
Copper ion electrode	8006-10C	0.06 ~ 6,400 ppmCu ²⁺	2565A	3014094398(9003016000)
Cadmium ion electrode	8007-10C	0.1 ~ 11,000 ppmCd ²⁺	2060A · 2565A	3014094399(9003016100)
Lead ion electrode	8008-10C	2 ~ 20,000 ppmPb ²⁺	2565A	3014094400(9003016200)
Thiocyanate ion electrode	8009-10C	0.6 ~ 5,800 ppmSCN ⁻	2565A	3014094401(9003016300)
Fluoride ion electrode (Combination type)*	6561-10C	0.02 ~ 19,000 ppmF ⁻	—	3014093431(9003014600)
Fluoride ion electrode	8010-10C	0.02 ~ 19,000 ppmF ⁻	2060A · 2565A	3014093439(9003016400)
Silver ion electrode	8011-10C	0.01 ~ 110,000 ppmAg ⁺	2565A	3014094402(9003016500)
Ammonia electrode (Combination type)*	5002A-10C	0.1 ~ 1,000 ppmNH ₃	—	3014093560(9003016600)
Sodium ion electrode	1512A-10C	2.3 ~ 230,000 ppmNa ⁺	2565A	3014068526(9003016700)
Nitrate ion electrode (Combination type)*	6581-10C	0.62 ~ 62,000 ppmNO ₃ ⁻	—	3014093432(9003014700)
Nitrate ion electrode	8201-10C	0.62 ~ 62,000 ppmNO ₃ ⁻	2565A	3014094403(9003016800)
Potassium ion electrode (Combination type)*	6582-10C	0.04 ~ 39,000 ppmK ⁺	—	3014093433(9003014800)
Potassium ion electrode	8202-10C	0.04 ~ 39,000 ppmK ⁺	2565A	3014094404(9003016900)
Calcium ion electrode (Combination type)*	6583-10C	0.4 ~ 40,080 ppmCa ²⁺	—	3014093434(9003014900)
Calcium ion electrode	8203-10C	0.4 ~ 40,080 ppmCa ²⁺	2060A · 2565A	3014068839(9003017000)
Chloride ion tip	7660	—	—	3014093436(9003015000)
Fluoride ion tip	7661	—	—	3014093438(9003015100)
Nitrate ion tip	7681	—	—	3014068364(9003015200)
Potassium ion tip	7682	—	—	3014069795(9003015300)
Calcium ion tip	7683	—	—	3014068795(9003015400)
Ammonia electrode membrane (6pcs)	membrane(NH ₃)	—	—	3014067083(9012001000)

* D-53 can use only combination type ion electrode.

DO electrode / DO Tip Line up

Electrode	Lead length	Model	Specification	Temp. range(°C)	Part No. (Old No.)
Waterproof DO electrode	2m	9551-20D	Field immersible type	0 ~ 40	3014047090(9096002300)
Waterproof DO electrode	10m	9551-100D	Field immersible type	0 ~ 40	3014047091(9096002400)
DO electrode	1m	9520-10D	Laboratory use	0 ~ 45	3014046711(9096000500)
DO tip	—	5401	Replacement electrode tip for 9551	—	3014072770(9003010000)
DO tip	—	7541	Replacement electrode tip for 9520	—	3014074145(9074000200)

Multi-parameter Water Quality Meters

U-50 Series

5 languages display

English

Japanese

Russian

Spanish

Portuguese

Measure and Display 11 Parameters Simultaneously with Innovative Features, Newly Designed Control Unit and Sensor Technology

Intuitive software assures ease of use and operation efficiency.

Experience the durability and performance of an instrument that exceeds your expectations in the field testing of ground water and surface water applications.

Measure and Display up to **11 Items** Simultaneously

Control Unit Features:

- Easy to read LCD Display
- One-hand operation
- On-screen icon displays battery power and GPS, USB and probe unit connectivity
- Quick-connect connector (cable to control unit)
- Shock resistant cover
- Backlight display



Operating instructions



Rugged Outdoor Design

Sensor Probe Unit Features:

- Turbidity Sensor conforms to US EPA method 180.1 (U-53/U-53G)
- Turbidity Sensor conforms to EN ISO 7027 (U-54/U-54G)
- Minimum dissolved oxygen sensor maintenance with screw-on type membrane cap
- Chemical resistant materials of construction
- Optional ToupH pH electrode* that is difficult to break
- Field replaceable sensors



*Prevents damage during maintenance.

U-5X series specification comparison list

	U-51	U-52	U-52G	U-53	U-53G	U-54	U-54G
pH	●	●	●	●	●	●	●
ORP (Oxidation Reduction Potential)	●	●	●	●	●	●	●
Dissolved Oxygen	●	●	●	●	●	●	●
Conductivity	●	●	●	●	●	●	●
Salinity	●	●	●	●	●	●	●
TDS (Total Dissolved Solids)	●	●	●	●	●	●	●
Seawater Specific Gravity	●	●	●	●	●	●	●
Temperature	●	●	●	●	●	●	●
Turbidity (LED)	—	●	●	—	—	●	●
Turbidity (Tungsten lamp)	—	—	—	●	●	—	—
Water depth	—	—	●	●	●	●*	●*
GPS	—	—	●	—	●	—	●

Note: *U-54/G(2m) don't have the feature of water depth.

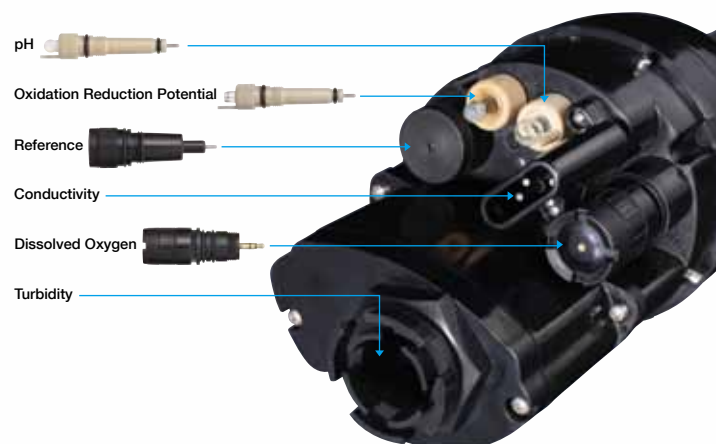

Water Quality Monitoring System

W-20XD Series

Measurement data is stored in the sensor probe offering the convenience to deploy the sensor probe without cable and control unit for continuous monitoring



1 month continuous monitoring

13 simultaneous parameters

Depth up to 100 meters

W-20XD series measurement parameters	W-22XD	W-23XD
Maximum probe size	47mm	97mm
pH	(●)	(●)
Dissolved oxygen	(●)	(●)
Conductivity	●	●
Salinity	●	●
Total dissolved solids (TDS)	●	●
Seawater specific gravity	●	●
Temperature	●	●
Turbidity	●	●
Depth	●	●
Oxidation reduction potential (ORP)	(●)	(●)
Data logging	●	●
100m depth mess.		●
Nitrate ion*		(●)
Calcium ion*		(●)
Chloride ion*		(●)
Fluoride ion*		(●)
Potassium ion*		(●)
Ammonia*		(●)

*Optional sensor (replacement with other ion sensors is possible).
6 ion options for the 3 available ports
(●)option

W-22XD sensor



- Dissolved oxygen sensor (replaceable)
- Depth sensor
- pH/ORP sensor (replaceable)
- Conductivity/temperature/turbidity sensors

W-23XD sensor



- Depth sensor
- Dissolved oxygen sensor (replaceable)
- pH/ORP sensor (replaceable)
- Conductivity/temperature/turbidity sensors
- Option Ion sensors (replaceable)

COMPACT pH METER

twin_{pH}
WATERPROOF

pH

Immersion, scoop, and flat measurement.



water proof

B-211	single-point pH7 Auto Calibration	NIST standard Solution
B-212	Two point pH7/pH4 Auto Calibration	NIST standard Solution
B-213	Two point pH7/pH4 Auto Calibration	US standard Solution

Measurement method	Glass electrode method
Measurement range	pH2 ~ 12
Repeatability	±0.1pH
Power supply	Two 3-volt lithium batteries
Mass	Approx. 53g.

COMPACT CONDUCTIVITY METER

Twin Cond

COND SAL

Two measurement methods: drop the sample on the sensor or immerse the sensor in the sample.



B-173

Measurement method	AC bipolar method
Measurement range	Conductivity 0 ~ 19.9mS/cm SALT 0 ~ 1.1% Temperature 5 ~ 35°C
Repeatability	±1% F.S.
Power supply	Two 3-volt lithium batteries
Mass	46g

COMPACT NITRATE ION METER

twinNO₃⁻

ION NO₃⁻

water proof

HORIBA's flat sensor enables easy measurement with only a few drops of sample.

B-341 (for crops)

B-342 (for soil)

B-343 (for general use)

	B-341 (for crops)	B-342 (for soil)	B-343 (for general use)
Measurement method	Ion electrode method		
Measurement range	NO ₃ ⁻ 100 to 9900 (ppm or mg/L) NO ₃ ⁻ -N 23 to 2200 (ppm or mg/L-N) NO ₃ ⁻ -N※1 -	30 to 600 (ppm or mg/L) 6.8 to 140 (ppm or mg/L-N) 3.4 to 68 (kg/10a)	62 to 6200 (ppm or mg/L) 14 to 1400 (ppm or mg/L-N) -
Repeatability	±10% ※2		
Power supply	CR2032 batteries (x2)		
Mass	Approx.52g (meter onry)		

※1 With soil/water sampling ratio of 1:5.
※2 Using HORIBA's prescribed method

CARDY Series

CARDY

ION

Compact SALT & ION meters



Na⁺ Ion meter

C-122 Na⁺

K⁺ Ion meter

C-131 K⁺

SALT meter

C-121 NaCl

	C-121/122 (NaCl/Na ⁺)	C-131 (K ⁺)
Measurement range	0.1%(w/w) ~ 10%(w/w) NaCl 23 ~ 2300ppm Na	39 ~ 3900ppm
Sample amount required	Approx. 0.1ml	Approx. 0.1ml
Sample temperature	5 ~ 35°C	5 ~ 35°C
Liquid junction	Porous macromolecule	Porous macromolecule
Mass	Approx. 40 g	

LAQUA's free arm electrode stand can handle any container size or position

The 360° rotating free arm also has a full range of vertical movement

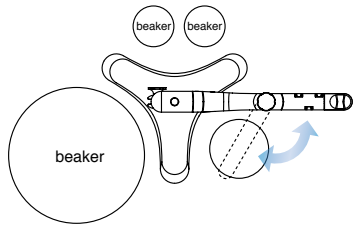

The full range of stand movements lets you arrange a variety of large and small containers wherever you please

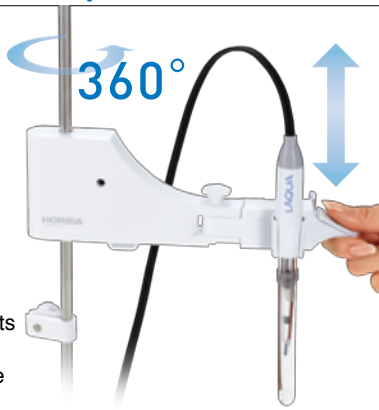

Long type electrode stand (Optional)

Easy measurement using large containers.
New long type electrode stand

450~650mm

- The long electrode stand has a maximum length of 650 mm, but can also be stored neatly thanks to the telescopic shaft.
- With the long electrode stand, you can prepare small quantities of standard solution for calibration and large capacity containers of buffer solution without having to detach and reattach the electrodes.

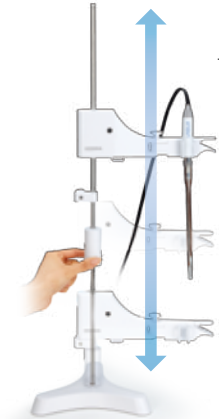

■ Dimension Unit: mm

● F-70 Series / DS-70 Series

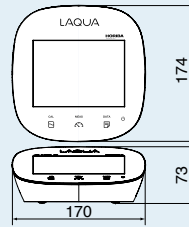

● D-50 Series / ES-51 / OM-51

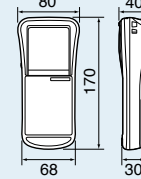

Long type electrode stand (optional)
P/N:3200382560

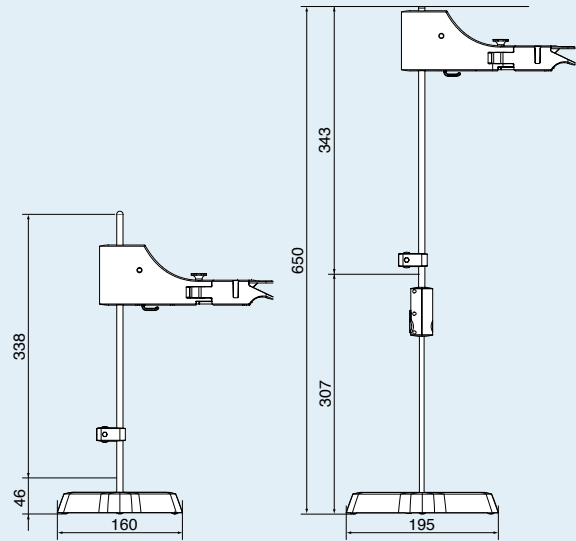

SUPPORT HORIBA CUSTOMER SUPPORT SYSTEM

HORIBA offers a variety of services to conform to quality standards and international guidelines such as GLP, GMP and ISO

Technical Support	User Support	Validation Support
Please contact us with any technical questions about our products. http://www.horiba.com/wq/support	Special website is available for the registered customers featuring: • Data collection software • Instruction manual downloads • Measurement tips, etc.	• Traceability certification* • IQ/OQ/PQ support* • SOP guidance • FAQ *Optional services

WEB SPECIAL WEBSITE OF LAQUA



Taking your comments and feedback to our heart, "LAQUA" is our new brand to deliver you our best solution to your needs. Please come visit our new "LAQUA" website.
<http://www.horiba.com/laqua>

HORIBA continues contributing to the preservation of the global environment through analysis and measuring technology.



Please read the operation manual before using this product to assure safe and proper handling of the product.

- The contents of this catalog are subject to change without prior notice, and without any subsequent liability to this company.
- The color of the actual products may differ from the color pictured in this catalog due to printing limitations.
- It is strictly forbidden to copy the content of this catalog in part or in full.
- All brand names, product names and service names in this catalog are trademarks or registered trademarks of their respective companies.

<http://www.horiba.com> e-mail: info@horiba.co.jp

● HORIBA, Ltd.
Head Office
2 Miyano Higashi, Kisshoin
Minami-ku, Kyoto, Japan
Phone: 81 (75) 313-8123
Fax: 81 (75) 321-5725

● Tokyo Sales Office
1-7-8 Higashi-Kanda
Chiyoda-ku, Tokyo, Japan
Phone: 81 (3) 3861-8231
Fax: 81 (3) 3861-8259

● HORIBA TRADING (SHANGHAI) CO., Ltd.
Shanghai Office
Room 1701, United Plaza,
1468 Nanjing Rd. West,
Shanghai, 200040, China
Phone: 21-6289-6060
Fax: 21-6289-5553

● Beijing Office
Room 1801, Capital Tower Beijing,
Tower 1 No.6Jia, Jianguomenwai Ave.,
Chaoyang District, Beijing,
100022 China
Phone: 10-8567-9966
Fax: 10-8567-9066

● HORIBA KOREA Ltd.
112-6 Sogong-Dong
Choong-ku, Seoul, Korea
Phone: 82 (2) 753-7911
Fax: 82 (2) 756-4972

● HORIBA INSTRUMENTS
Pte. LTD.
10 Ubi Crescent
#05-11/12, Ubi Techpark
Singapore 408564
Phone: 65 6745-8300
Fax: 65 6745-8155

● HORIBA India Private Limited
Delhi Office
1212A, Hemkunt Tower,
98 Nehru Place,
New Delhi - 110019 INDIA
Phone: +91 11-4669-5001/5002

● Pune Office
502, Purushottam Plaza,
Baner Road, Baner,
Pune - 411045 INDIA
Phone: +91 20-2729-1121

● HORIBA INSTRUMENTS
INCORPORATED
Irvine Facility
17671 Armstrong Avenue
Irvine, CA 92614, U.S.A.
Phone: 1 (949) 250-4811
Fax: 1 (949) 250-0924

● HORIBA INSTRUMENTS
LIMITED
Kyoto Close
Summerhouse Road
Moulton Park, Northampton
NN3 6FL, U.K.
Phone: 44 (1604) 542500
Fax: 44 (1604) 542699

● HORIBA GmbH
Kaplanstrasse 5
A-3430 Tulln,
Austria
Phone: 43 (2272) 65225
Fax: 43 (2272) 65230

● HORIBA CZECHIA
Organizace slozka Praha
Petrohradská 13
CZ-101 00 Praha 10,
Czech Republic
Phone: 420 (2) 717-464-80
Fax: 420 (2) 717-470-64

● HORIBA EUROPE GmbH
Head Office
Hans-Mess-Str.6
D-61440 Oberursel/Ts.
Germany
Phone: 49 (6172) 1396-0
Fax: 49 (6172) 137385

● Leichlingen Facility
Julius-kronenberg Strasse
D-42799 Leichlingen
Germany
Phone: 49 (2175) 8978-0
Fax: 49 (2175) 8978-50

● HORIBA FRANCE
12, Avenue des Tropiques
91955 LES ULIS
France
Phone: 33 (1) 69-29-96-23
Fax: 33 (1) 69-29-95-77