



**Wissenschaftlich-Technische
Werkstätten GmbH & Co. KG**

Dr. Karl-Slevogt-Straße 1

D-82362 Weilheim

Tel 0881 / 183-0

Fax 0881 / 6 25 39

E-Mail Info@WTW.com

Internet <http://www.WTW.com>

**Prof. Dr. Harald Platen
Anna Wirtz**

Fachbereich KMUB
Umwelt- und Hygienetechnik
und
Zentrum für Umwelttechnologie

Wiesenstrasse 14
D-35390 Giessen

Telephone and fax:
+49-641-3092533

e-mail:
harald.platen@tg.fh-giessen.de

Web site:
http://www.fh-giessen.de/WEB_TG/uhf.htm

**Matrix: Soils and solids
Applications of analysis
no. 1**

**Measurement of the
respiration activity of
soils using the
OxiTop® Control
measuring system**

**Basic principles and
process characteristic
quantities**

1st edition : July 1999

Abbreviations

ADP	Adenosindiphosphate
ATP	Adenosintriphosphate
BSB	Biochemical oxygen demand [mg/L]
CSB	Chemical oxygen demand [mg/L]
m	Mass [g]
M_R	Relative molecule mass [g/mol]
n	Amount of substance [mol]
NADP	Nicotinamidadeninucleotide phosphate, oxidized form
NADPH	Nicotinamidadeninucleotide phosphate, reduced form
p	Pressure [Pa] or [bar]; 1 bar = 1000 hPa = $10^5 \text{ Nm}^{-2} = 10^5 \text{ kgm}^{-1} \text{ s}^{-2} = 100 \text{ JL}^{-1}$
R'_{CO_2}	Special gas constant of CO_2 at 273 K and 1013 hPa [$8.2502 \text{ Jmol}^{-1} \text{ K}^{-1}$] from [10]
R'_{O_2}	Special gas constant of O_2 at 273 K and 1013 hPa [$8.301 \text{ Jmol}^{-1} \text{ K}^{-1}$] from [10]
R	General gas constant (at 273.15 K and 1013 hPa): $8.3144 \text{ Jmol}^{-1} \text{ K}^{-1}$
T	Absolute temperature [K]
ThOD	Theoretical oxygen demand [mg/g]
TS	Dry substance [%]
V	Volume [L]

Introduction

Although biological activity has already been utilized for decades as the quantity under test in routine measuring processes (BOD, spontaneous oxygen consumption [1, 2]) in the inspection of water to gauge pollution effects, comparable procedures in soil examination have not achieved any great significance up to now although they have been recognized for a long time [3]. The reason was that there was no measuring procedure available that was easy to use: they were either time consuming or demanding with regard to instrumentation and, thus, cost intensive (see [4] for an overview). Due to the increasing demand for a biological soil sanitation procedure within the field of pollution and also as a result of questions concerning biological waste treatment, an increasing requirement arose for simple biological measuring procedures for solids and recommendations for measuring procedures were made [5, 6]. The basic data of one measuring procedure that can be used for simple and reproducible measurements of biological activity in soils, refuse, composts and other solids are presented below.

Material

OxiTop®-C measuring sensors (WTW, Weilheim, FRG)
OxiTop® OC110 controller (WTW, Weilheim, FRG)
ACHAT OC PC communication software (WTW, Weilheim, FRG)
Data transmission cable, type AK 540/B for RS 232 (WTW, Weilheim, FRG)
Measuring vessel MG 1.0 and 1.5 with DV/MG lid-locking device (WTW, Weilheim, FRG)
Temperature-controllable chamber or temperature-controlled cabinet of the variants, TS606/2....TS606-G4/Var (WTW, Weilheim, FRG)
Personal computer, minimum requirement: 80486 processor, 16 MB RAM, RS232 interface
Windows 3.1 or 3.11 operating system (Microsoft Corporation, USA)
EXCEL®5.0 spreadsheet program (Microsoft Corporation, USA)
Single-trip jar, 0.55 L volume (Weck, Wöhr-Öflingen, FRG), Vaseline
Laboratory balance (least reading: min. 0.1 g) for weighing quantities of soil
Laboratory balance (least reading: min. 0.1 g) for preparation of reagents
Beakers (50 mL)
Transfer pipette, 50 mL
Measuring cylinder, 50 mL
Caustic soda solution (1 mol/L), caustic soda solution (2 mol/L)
Sodium hydroxide (pellets), soda lime
Deionized water

Basic principles of the procedure

1. Oxygen consumption and formation of carbon dioxide by aerobic organisms

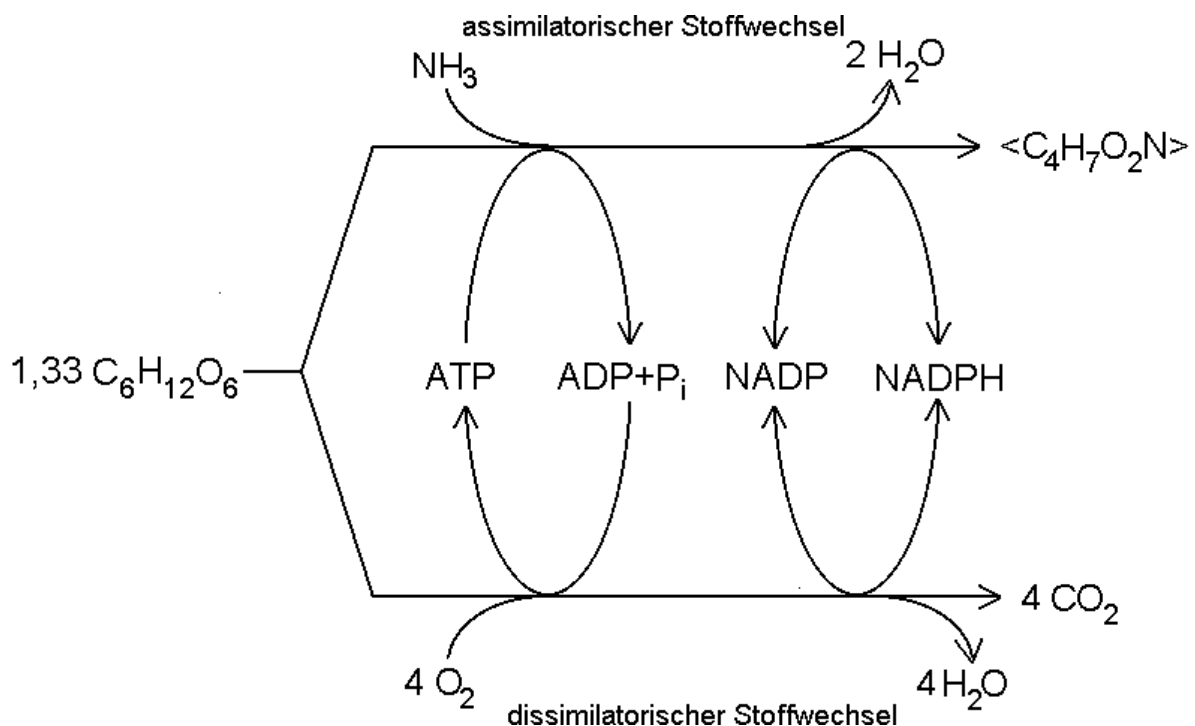
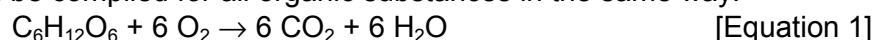

Figure 1:

The aerobic decomposition of an organic substance (demonstrated simply using the example of glucose). On the one hand, the organic substances are mineralized to CO₂ and H₂O where energy is conserved in the form of ATP (dissimilatoric metabolism), and, on the other hand, converted into cell substance ("C₄H₇O₂N") where ATP is again consumed as an energy source (catabolic metabolism). Both types of metabolism are also linked via NADP that provides or subtracts electrons ("bound hydrogen") as required. The consequence of the "divided" metabolism method is that, in the decomposition of a specific amount of substrate, only one part of the theoretically calculated oxygen (ThOD) is consumed (usually between 40 and 60%). The stoichiometry shown in the diagram portrays an ideal relationship. Actual relationships frequently exhibit deviations from this according to the efficiency with which the metabolism of an organism functions.

As shown in fig. 1, biologically degradable organic substances are degraded to carbon dioxide with the consumption of oxygen under aerobic conditions. Equation 1 illustrates this using the example of glucose again; equations can be compiled for all organic substances in the same way.



The "theoretical oxygen demand" (ThOD) for the complete oxidation of a substance can be calculated from the stoichiometry. For the reaction given in equation 1, this is equal to 6 mol O₂/mol glucose or – referred to mass – 1066 mg O₂/g. In the ideal case, the ThOD (arithmetic value) is identical with the COD (measured value) if the inspected substance is completely oxidized by the chemical oxidation medium.

If organisms use a chemical substance as a source of energy and material, they only oxidize a part of the substrate during the consumption of oxygen. The other part is used for the constitution of cell substance (see fig. 1). As a result, less oxygen is consumed for the complete biological elimination of an organic substance from an environmental compartment (soil, water, etc.) than the ThOD dictates.

2. Basic principles of manometric oxygen measurement

Manometric oxygen consumption measurement is the procedure that has been practiced since the 20s for the characterization of respiration processes ("Warburg procedure"; see [11]) and is also a proven procedure in the analysis of water. The mercury manometer was the measuring instrument used for this procedure although it has now been replaced by new developments in the field of sensor technology [7]. However, these are not licensed at the moment for official measurements within the framework of wastewater control.

The principle of manometric oxygen determination is based upon oxygen being consumed by organisms while carbon dioxide is formed at the same time. This latter gas is bound by an absorbing agent and, thus, does not appear in the form of a free gas. Consequently, the change in pressure is attributed to the consumption of oxygen only. For the oxygen consumption to be measured manometrically, the following conditions must be fulfilled:

- The (biologically active) sample must be contained in a vessel that is impermeable to gas.
- There must be an appropriately large headspace of air located above the sample to provide unrestricted oxygen for the biological decomposition processes.
- The measuring vessel must house an agent for absorbing carbon dioxide without the sample coming into contact with it.
- A suitable pressure measuring device must be attached to the reaction vessel.
- The reaction vessel must be kept in a temperature constant location during the measurement. Temperature changes lead to pressure fluctuations that render an oxygen consumption measurement impossible (see section 6).

The biological processes lead to a consumption of oxygen with the simultaneous formation of approximately equimolar quantities of carbon dioxide that is bound by an alkaline absorbing agent (e.g. sodium hydroxide, caustic soda solution, soda lime or potassium hydroxide). Equation 2 presents the reaction of carbon dioxide with sodium hydroxide as an example.

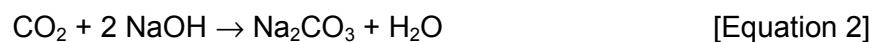

The minimum stoichiometric amount of absorbing agent that must be contained within the reaction vessel for the complete measuring range to be exhausted (Tab. 1) can be calculated from equation 2. Too low an amount of absorbing agent leads to results that are too low. As will be shown later, at least a multiple amount of absorbing agent must be present to ensure the absorption is sufficiently rapid and complete.

The correlation between the change in pressure and oxygen consumption is given by equations 3 and 4. The general gas equation states that, at a constant vessel volume and constant temperature, any change in pressure can be attributed to a change in the amount of substance:

$$\Delta p = \Delta n \cdot R' \cdot T \cdot V^{-1} \quad [\text{Equation 3}]$$

The amount of substance is derived from the quotient, m/M , and, consequently, the equation appears as follows:

$$\Delta p = \Delta m \cdot R' \cdot T \cdot V^{-1} \cdot M_R^{-1} \quad [\text{Equation 4}]$$

Corresponding to the change in pressure, correlating amounts of oxygen depending on the vessel size, temperature and bulk density are listed in table 2.

Table 1:

Stoichiometric amounts of NaOH for the absorption of the maximum amount of CO₂ formed in the measuring vessels. The basis of the calculation is that, for each oxygen molecule that is consumed, a molecule of carbon dioxide is formed. In fact, this only applies for substances with a middling redox state of carbon (± 0). In highly oxidized substances such as, e.g. formic acid, two mol of carbon dioxide are formed for each mol of oxygen consumed whereas in heavily reduced substances (such as methane), the carbon dioxide formation is lower for the same oxygen consumption.

Volume of the reaction vessel [L]	Oxygen content in the reaction vessel ¹⁾ [mL]	Amount of substance of the carbon dioxide formed ²⁾ [mol]	Equivalent amount of sodium hydroxide for complete CO ₂ absorption ³⁾ [g]
0.55	115	0.00479	0.191
(MG1.0) 0.96	202	0.00834	0.334
(MG1.5) 1.50	315	0.01303	0.521

Note: The free gas volume is calculated from the difference of all the components contained in the reaction vessel/ volume of the total volume.

¹⁾ Volume of the reaction vessel x 0.21 (partial pressure oxygen in air)

²⁾ $n = p \cdot V / R \cdot T$ with $p = 0.21 \text{ bar} = 21000 \text{ Nm}^{-2}$; $V =$ value in column 1 x $0.001 \text{ m}^3/\text{L}$,
 $R_{\text{CO}_2} = 8.2502 \text{ Jmol}^{-1}\text{K}^{-1}$ (special gas constant for CO₂ under normal conditions); $T = 293 \text{ K}$

³⁾ 2 mol NaOH binds 1 mol CO₂; $M_R (\text{NaOH}) = 40 \text{ gmol}^{-1}$; $m = n \cdot M_R$; see also the remarks in the text accompanying the table

3 A measuring vessel for the proven "vacuum processing": the single-trip beaker

The demand for the development of a cost effective measuring system for soil respiration requires the use of commercial vessels and measuring instruments as far as possible. In the selection of measuring vessels, single-trip beakers [12, 13, 14] that have been used since the introduction of the titrimetric method (Isermeyer, 1952 [3]) were selected for the relevant measurements.

- Everyday use has shown that these beakers can be reliably closed with a suitable lid and rubber seal and that they are impermeable to gas.
- They are economical and can be obtained in standard forms and vessel sizes.
- Commercial sizes are available for uniform lid forms.
- The opening is so large that "solid samples" can easily be introduced into the vessel.
- As a result of the size of the opening, it is easy to, e.g. mix the samples by hand that is particularly advantageous in the subsequent introduction of additives to the soil.
- Cleaning the vessels after they have been used is simple.

These advantages led to the development of a special lid for single-trip beakers that fulfills several requirements:

- Adapter for attaching the OxiTop® / OxiTop® -C sensor
- Gas impermeable sealing of the measuring vessel
- Simple removal of the holder of the CO₂ absorbing agent

In addition to this development, another system was developed that uses wide-mouthed screw cap bottles and that has a particular advantage in providing sterile operation [8]. The applications of this measuring system are described in other application reports (e.g. in [8]).

4 Description of the DV/MG lid-locking device

The DV/MG lid-locking device used in measuring vessels of the type, MG1.0 / MG1.5, is shown below in fig. 2.

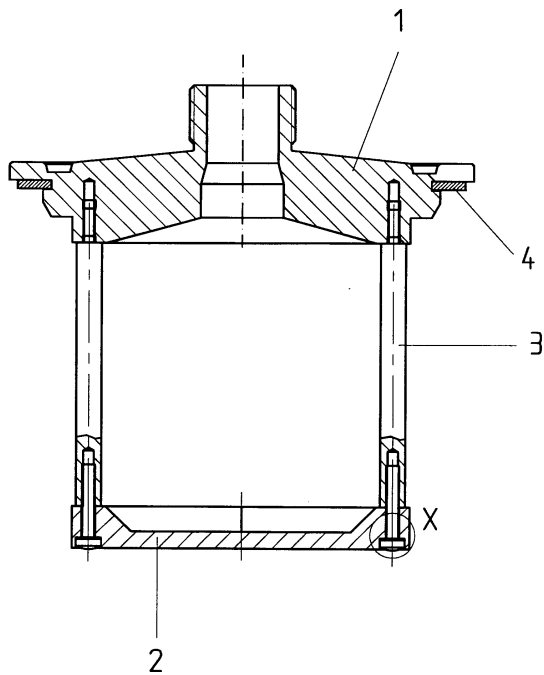

Figure 2:

DV/MG lid-locking device

1. Lid with screw connection for OxiTop® / OxiTop®-C sensor
2. Base of CO₂ absorption vessel
3. Fixing bolts of the base
4. DV/MG/DI lid seal

The fixing bolts and base are simple to remove.

Diagram: WTW, Weilheim, FRG

5 Checking the sealing of the system

To check the sealing, the lid-locking devices were provided with an additional drilled hole (8 mm) that was closed by a suitably impervious butyl rubber stopper. The rubber seals of the lid were lightly smeared with Vaseline and the lid was clamped to the measuring vessel by 4 clips (1 L) (Caution! Do not use silicone grease as this can damage the sensors if they come into contact). After the rubber stopper was inserted into the threaded connection, the sensor was tightly screwed on. Do not grease the seal and screw connector of the sensor!

After raising the temperature to 20°C, the sensors were started by the controller with a measuring duration of 10 days. The measuring vessels remained at 20°C in the temperature-controlled room during the entire measuring period. Shortly after beginning the measurement, the respective rubber stopper was pierced by a hollow needle and 200 mL air was removed by a syringe. After withdrawing the hollow needle, the test experiment remained in this room for 10 days. During this period, the pressure in the measuring vessels remained constant (confirmed by several runs). This confirmed the sealing and suitability of the measuring vessel for manometric measurements.

6 Effect of temperature and light

Instable temperature conditions lead to heavy fluctuations in the measurements. This is a result of the temperature dependency of the pressure that can be calculated from equation 5 (T = absolute temperature):

$$p_2 = p_1 * T_2/T_1 \quad \text{[Equation 5]}$$

At a starting pressure of 1000 hPa and a starting temperature of 20°C (293 K), the pressure increases to 1003 hPa for an increase in temperature of 1°C. At a resolving power of the measuring system of 1 hPa, this constitutes an error that cannot be ignored.

In addition, the effect of sunlight was investigated. This showed that the light beams led to a rapid increase in pressure, particularly if a damp soil was in the measuring vessel. This lay in the fact that the dark soil absorbed light very well and warmed up as a result!

Therefore, the measuring experiments had to be incubated in a dark location at a constant temperature such as that typically provided by thermostatic chambers or air-conditioned rooms.

7 Absorption rate using sodium hydroxide, soda lime and caustic soda solution

During manometric respiration measurement, three processes are superimposed:

- a) the consumption of oxygen,
- b) the formation of CO₂ by organisms and
- c) the absorption by the respective absorption medium used.

If the CO₂ absorption occurs too slowly and, thus, free CO₂ collects in the headspace, the change in pressure would no longer be proportional to the oxygen consumption. For this reason, the absorption response of various absorbing agents was studied. The OxiTop®-C measuring system enables reliable short-term measurements to be performed very simply and almost continuously with a large number of measuring data.

Brief description of the method:

The behavior of the absorbing agents, sodium hydroxide pellets, caustic soda solution and soda lime) was investigated.

To do this, the respective absorbing agent was poured into a 50 mL beaker and closed with a lid that could be opened or closed externally through the vessel wall without any physical contact (magnetic coupling). The beaker was placed in a 1 L measuring vessel. The lid-locking device had a butyl septum access that is impermeable to gas. After starting the tightly screwed on OxiTop®-C

sensor, 59 mL air was removed via the septum using a hollow syringe and the same amount of CO_2 was injected; this process was already registered with started sensors. After raising the lid of the absorption vessel by holding a magnet to it externally, the reduction in pressure was measured for 2 to 3 hours. All the activities were performed with material previously raised to 20°C in a temperature-controlled chamber.

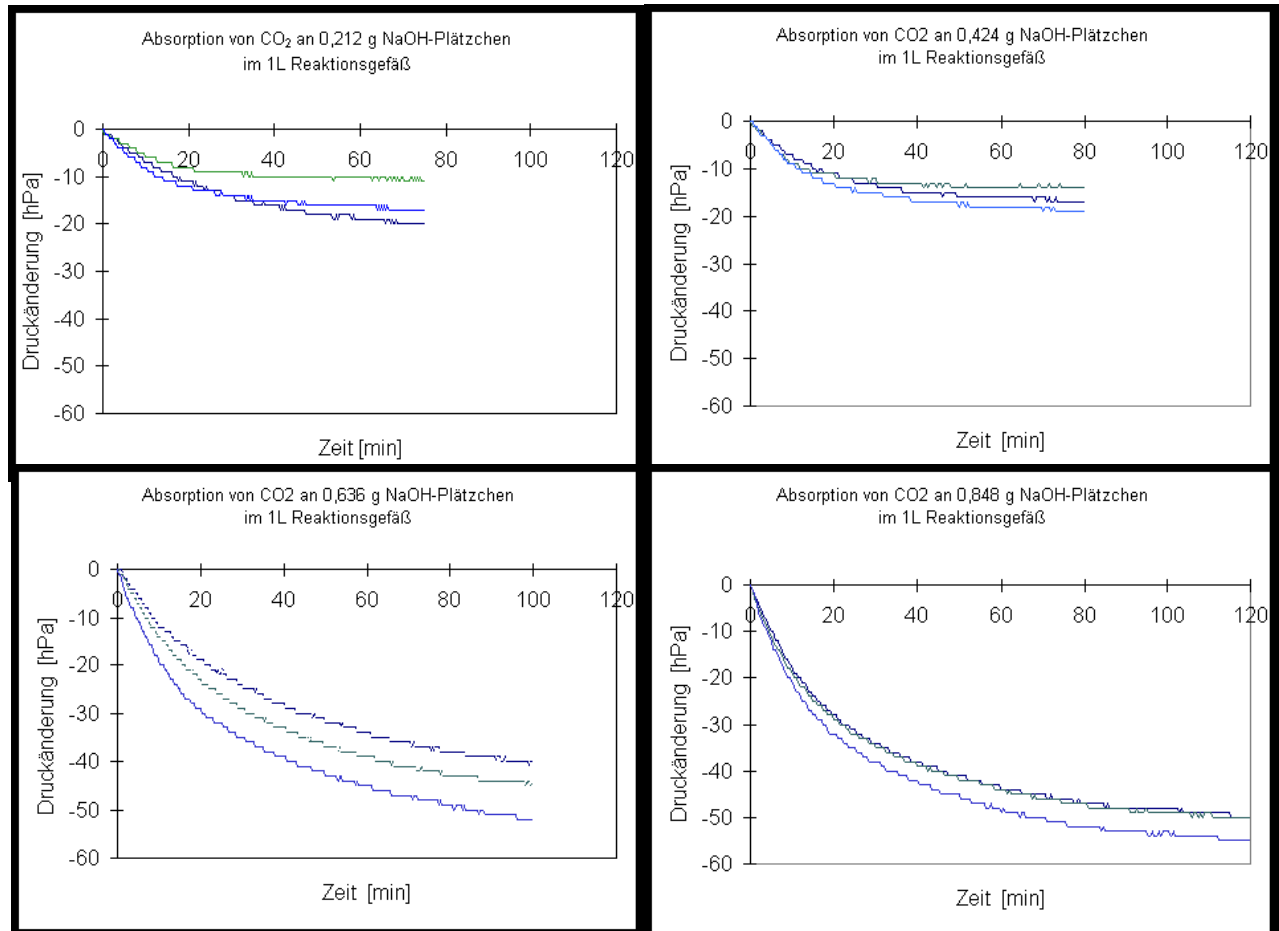

Figure 3:

Absorption of CO_2 by sodium hydroxide pellets at 20°C . (The results of multiple measurements are shown in each case). Increasing amounts of absorber were added to the 50 mL beakers in 1 L measuring vessels (see titles of the individual diagrams; 5.3, 10.6, 15.9 and 21.2 mmol NaOH respectively). After the vessels were closed, 59 mL air was removed from each of them and immediately replaced by 59 mL CO_2 (= 2.4 mmol). The sensor was started and the reduction in pressure recorded. The stoichiometric ratio of NaOH to CO_2 showed ratios of approximately 1:1, 1:2, 1:3 and 1:4. The measurements show that at least 4 times the stoichiometric amount of NaOH pellets must be used to achieve a complete and rapid absorption of CO_2 . The same stoichiometric amount or twice the stoichiometric amount of NaOH is simply insufficient for successful measurement.

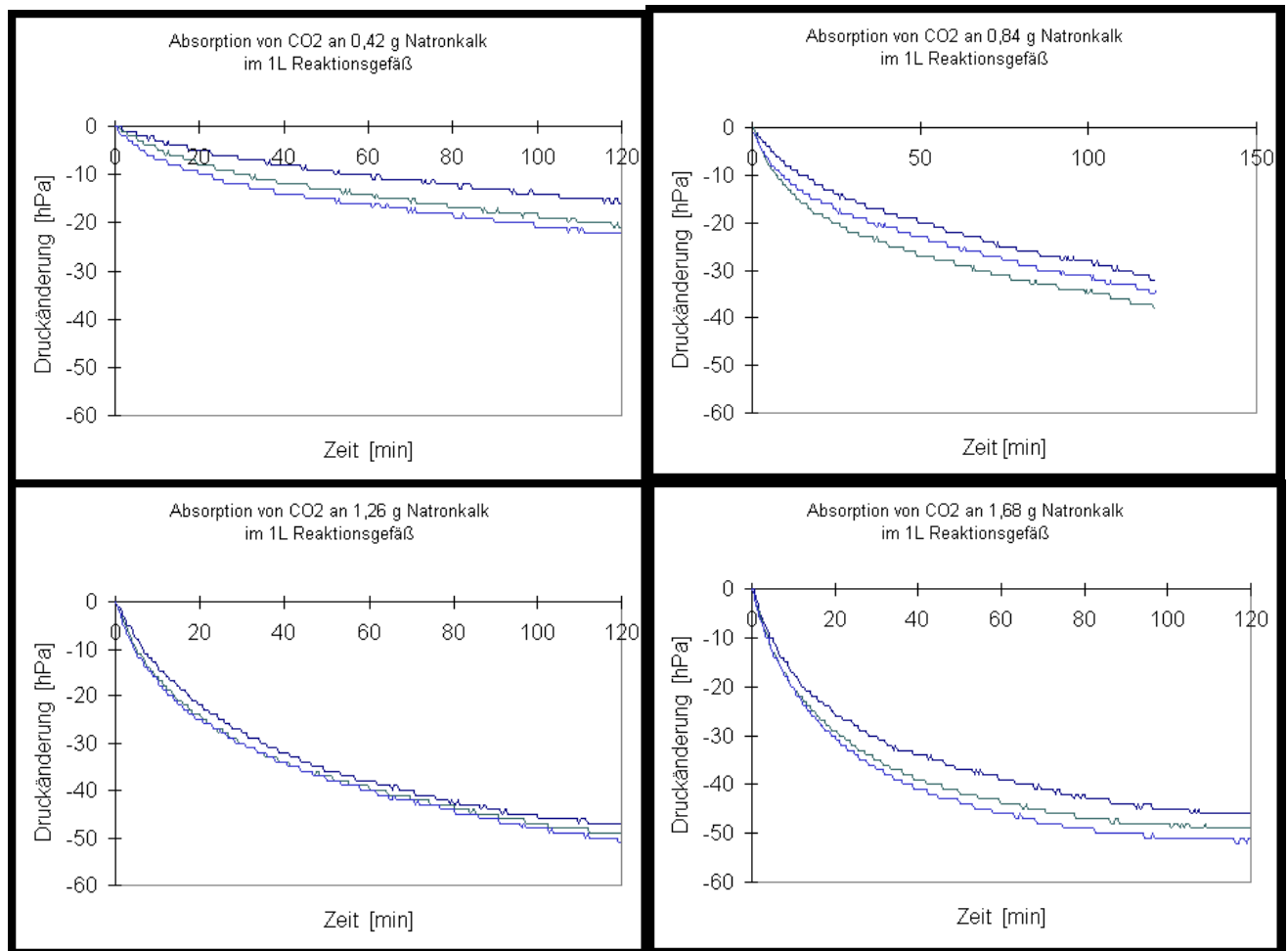
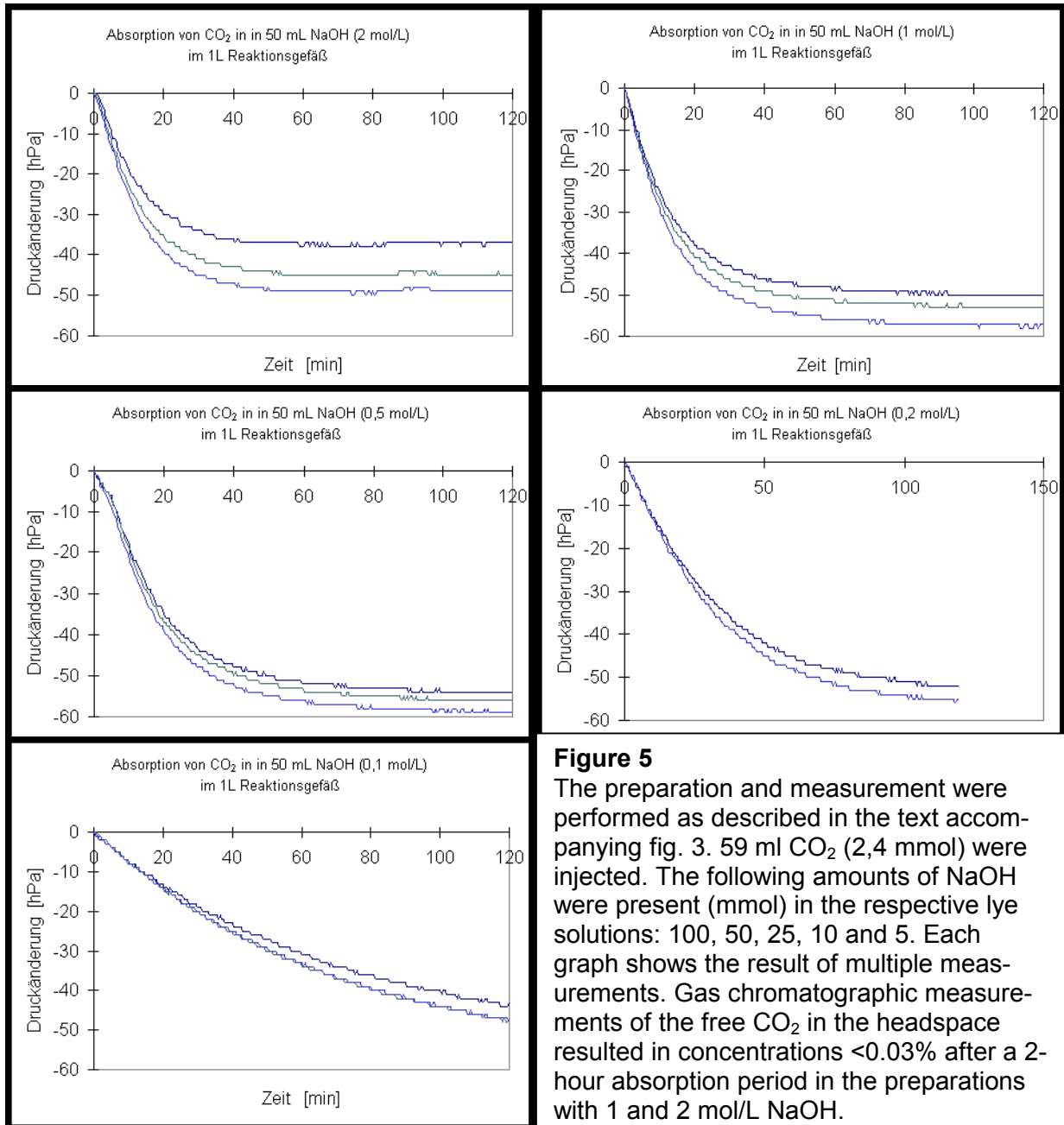

Figure 4:

The measurements and sample preparations were performed as described in the text accompanying fig. 3. Here too, 59 mL CO₂ was injected into the vessels (2.4 mmol; 106 mg) for absorption. The results of multiple measurements are shown in each case. The CO₂ absorption capacity of the soda lime is 28%, corresponding to a maximum of 118, 235, 353 and 470 mg). This also indicates that a significant excess of absorbing agent must be present to ensure the rapid and complete absorption of the CO₂.

The results indicate that caustic soda solution (50 mL, 1 mol/L) is the best absorbing agent for working with soil, followed by soda lime. The use of solid sodium hydroxide is not recommended as this dries out the soil (see section 8).

- The absorption capacity is totally adequate (sufficient excess)
- The absorption rate is high and does not run slower even if 200 mL CO₂ have already been absorbed (see fig. 6)
- The soil sample remains practically unchanged with respect to the water content (see fig. 7)
- The caustic soda solution can be titrated with HCl (1 mol/L) and, thus, the amount of CO₂ formed is obtained as additional information (see [3], although for more concentrated NaOH; see also [9]).



8 Absorption rate at increasing saturations of the absorbing agent

In the previous studies, the absorption rate was studied with a single injection of carbon dioxide (59 mL). In a 1 L measuring vessel, it is to be expected that up to 200 mL CO₂ will be absorbed during the course of a measurement. As a result, an investigation was made to see whether the absorption rate changes when a multiple amount of CO₂ is injected. To do this, 50 mL caustic soda solution (1 mol/L) was poured into a 1 L measuring vessel, 59 mL air was removed and, finally, the same amount of CO₂ was injected. The reduction in pressure was registered for approximately an hour and then another 59 mL CO₂ was injected. This procedure was repeated 6 times so that a total 354 mL CO₂ was injected. This corresponds to an amount of substance of 14.4 mmol where the caustic soda solution contained a total of 50 mmol NaOH (from the point of view of stoichiometry, this is approx. 1.7 times the amount of absorbing agent). The result (fig. 6) shows that the absorption rate did not slow down with increasing saturation within the concentration range of interest.

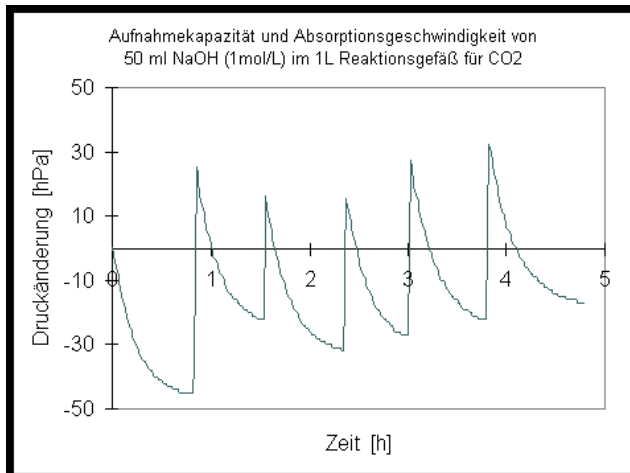

Figure 6: Effect of multiple CO₂ injections (59 mL each time) on the absorption rate in a 1 L measuring vessel with 50 mL NaOH (1 mol/L) at 20°C.

9 Effect of absorbing agents on the water content of soils

Absorbing agents also frequently bind water in addition to CO₂. This can lead to a drying out of the soil samples in the vessel. For this reason, the three absorbing agents mentioned above were tested for this effect.

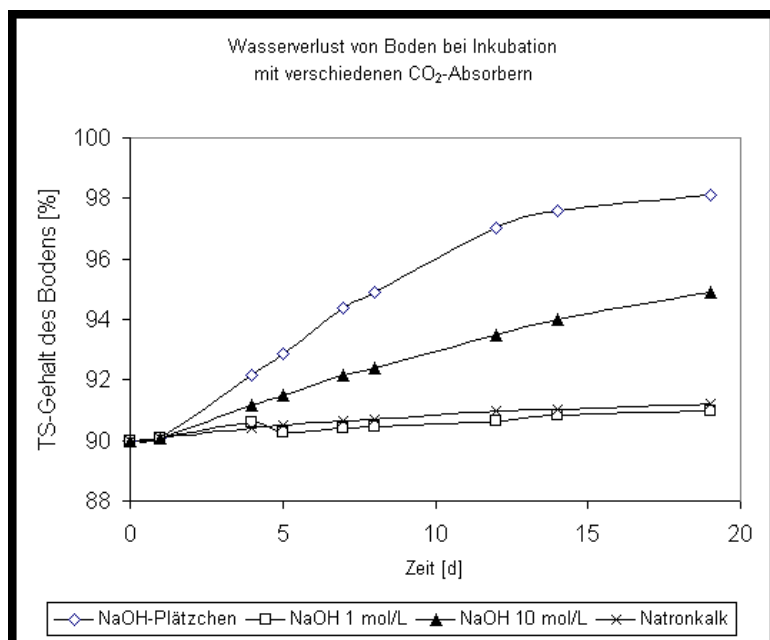

Figure 7

Dependence of the dry substance content of a soil during incubation using various absorbing agents. Four preparations, each with 100 g soil dry material (moistened with 11 g water), were prepared (corresponds to a water content of 10% or dry material content of 90%). 4 g NaOH pellets, 50 mL NaOH (1 mol/L), 10 mL NaOH (10 mol/L) and 4 g soda lime were used as the absorbing agents. The preparations were closed and incubated in the dark at 20°C. The vessels were opened at regular intervals and the increase in weight of the absorbing agents was measured. The water loss of the soil was determined from these values and, with it, the change in the dry material.

10 Equation for calculating the oxygen consumption

The basic calculation of oxygen consumption in aqueous systems is given by the BOD equations (see WTW BOD Primer). [15]

These equations cannot be used directly for soils.
Equation 6 applies to the incubation

Calculating the soil respiration

$$BA = \frac{M_R(O_2)}{R \cdot T} \cdot \frac{V_{fr}}{m_{Bt}} \cdot \Delta p \quad [\text{Equation 6}]$$

BA = soil respiration [in mgO₂ / kgTS]

M_R(O₂) = molar mass of oxygen : 32000 mg/mol

V_{fr} = free gas volume [in L] (see equation 7)

R = general gas constant: 83,14 L mbar mol⁻¹ K⁻¹

T = measuring temperature [in K]

m_{Bt} = mass of dry soil substance in the measuring preparation

Δp = reduction in pressure of the measuring preparation [in mbar]

Result specifying the measuring period and the incubation temperature

Example: soil respiration (20°C) = 360 mg O₂/kg TS in 4 days

Note:

The use of the general gas constant R instead of the specific gas constant R' for oxygen (20°C) provides sufficiently accurate results (error <0.5%) for most practical applications.

For each measuring preparation, the "free gas volume" must be known

Calculating the free gas volume:

$$V_{fr} = V_{ges} - V_{AG} - V_{AM} - V_{Bf} \quad [\text{Equation 7}]$$

V_{fr} = free gas volume [in L]

V_{ges} = total volume of headspace enclosed in the measuring vessel by the lid [in L]
(without soil, without absorption vessel, without absorbing agent)

V_{AG} = characteristic volume of the vessel for the absorbing agent [in L]

V_{AM} = characteristic volume of the absorbing agent [in L]

V_{Bf} = volume of the moist soil [in L]

Calculating the dry soil substance used:

$$m_{Bt} = m_{Bf} \cdot \frac{TS}{100\%} \quad [\text{Equation 8}]$$

m_{Bt} = mass of dry soil substance [in kg]

m_{Bf} = mass of moist soil substance [in kg]

TS = dry soil substance content [in %]

100% = correction term

Table 2 lists examples of the oxygen amounts that correlate to a corresponding change in pressure for some standard measuring preparations. The calculation is made using equation 9:

$$\Delta m = \Delta p \cdot V_{fr} \cdot M_R / (R'_{O_2} \cdot T) \quad [\text{Equation 9}]$$

$$\Delta p = 1 \text{ hPa} = 0.1 \text{ JL}^{-1}; T = 293 \text{ K}; M_R = 32 \text{ g mol}^{-1}; R'_{O_2} = 8.301 \text{ J mol}^{-1} \text{ K}^{-1};$$

Table 2:

Derivation of the amount of oxygen that correlates to a change in pressure of 1 hPa for various trial preparations.

Measuring vessel	Volume with DV/MG ¹⁾	Quantity of soil	Soil volume ²⁾	Volume of the absorption vessel	Volume of absorption agent	Free gas volume V _{fr} ³⁾	Amount of oxygen consumed at a change in pressure of 1 hPa ³⁾
MG 1.0	960 mL	100g TS +10g H _a O	0.06 L	0.01 L	0.05 L	0.84 L	1.11
MG 1.0	960 mL	200g TS +20g H _a O	0.12 L	0.01 L	0.05 L	0.78 L	1.03
MG 1.0	960 mL	300g TS +30g H _a O	0.18 L	0.01 L	0.05 L	0.72 L	0.95
MG 1.5	1500 mL	100g TS +10g H _a O	0.06 L	0.01 L	0.05 L	1.38 L	1.82
MG 1.5	1500 mL	200g TS +20g H _a O	0.12 L	0.01 L	0.05 L	1.32 L	1.74
MG 1.5	1500 mL	300g TS +30g H _a O	0.18 L	0.01 L	0.05 L	1.26 L	1.66
Preserve jar, 0.5 L	550 mL	100g TS +10g H _a O	0.06 L	0.01 L	0.05 L	0.43 L	0.57

- 1) The volume of the vessel was measured in liters after the lid was attached (tolerance: ± 2%)
- 2) The volumes for dry soil is assumed in this table of examples to be 0.5 mL pro g DS for simplicity on the basis that this is approximately true for many cases. For practical purposes, the actual soil volumes must be determined experimentally to be accurate enough for precise measurements
- 3) Calculated using equation 9

**Note: A technical change in the construction of the lid resulted in other free gas volumes.

We recommend determining the free gas volumes by measuring them in liters before beginning the trial.

Bibliography

- [1] DIN 38409 Teil 51 (1987). Bestimmung des Biochemischen Sauerstoffbedarfs in n Tagen nach dem Verdünnungsprinzip (Verdünnungs-BSB). In: Deutsche Einheitsverfahren zur Wasser-, Abwasser- und Schlammuntersuchung (H 51). 18. Lieferung. VCH, Weinheim, FRG und Beuth-Verlag, Berlin, FRG.
- [2] DIN 38409 Teil 52 (1987). Bestimmung der Sauerstoffzehrung in n Tagen. In: Deutsche Einheitsverfahren zur Wasser-, Abwasser- und Schlammuntersuchung (H 52). 18. Lieferung. VCH, Weinheim, FRG und Beuth-Verlag, Berlin, FRG.
- [3] Isermeyer, H. (1952). Eine einfache Methode zur Bestimmung der Bodenatmung und der Karbonate im Boden. Z. Pflanzenern. Bodenk. **56**: 25-38
- [4] Alef, K. (1995). Soil respiration. In: Alef, K., Nannipieri, P. (eds.). Methods in applied soil microbiology and biochemistry. Academic Press, London, UK: 214-219.
- [5] DECHEMA (1992). Labormethoden zur Beurteilung der biologischen Bodensanierung. 2. Bericht des interdisziplinären Arbeitskreises "Umweltbiotechnologie - Boden", Frankfurt, FRG
- [6] DECHEMA (1995). Biologische Testmethoden für Böden. 4. Bericht des interdisziplinären Arbeitskreises "Umweltbiotechnologie - Boden", Frankfurt, FRG
- [7] Wagner, I., Fink, W. (1996). Ein quecksilberfreies BSB-Meßsystem zur Bestimmung des Biochemischen Sauerstoffbedarfs. Korresp Abw 43: 517-522.
- [8] Robertz, M., Eckl, S., Muckenheim, T., Webb, L. (1997). Kostengünstige Methode zur Bestimmung der Bodenatmung belasteter und unbelasteter Böden. Applikationsbericht AL 97004, Forschungszentrum Jülich, FRG.
- [9] Platen, H., Wirtz, A. (1998). Applikationen zur Analytik Nr. 4: Messung von Sauerstoffverbrauch (manometrisch mit OxiTop®-Contol) und Kohlendioxidbildung (titrimetrisch), Fachhochschule Gießen-Friedberg, Wiesenstraße 14, 35390 Gießen. 1. Auflage
- [10] Christen, H. R. (1977). Grundlagen der allgemeinen und anorganischen Chemie. 5. Auflage, Verlag Sauerländer-Salle, Frankfurt, FRG, S. 175
- [11] Lehninger, A. L. (1983). Biochemie, Verlag Chemie, Weinheim, FRG: 306-307.
- [12] Platen, H., Sommer, I. (1997). Bestimmung der Atmungsaktivität von Böden. TerraTech 3/1997: 23-25.
- [13] Sommer, I. (1996). Entwicklung und Prüfung eines neuen Meßsystems zur Bestimmung der Bodenatmung mit anschließenden Versuchen zur Korrelation mit der Mikroorganismenzahl. Diplomarbeit, Fachhochschule Gießen-Friedberg, Fachbereich KMUB, Wiesenstraße 14, 35390 Gießen.
- [14] Mößner, R. (1997). Weiterführende Untersuchungen zur Anwendbarkeit des OxiTop®-OECD-Meßsystems zur Bestimmung der Bodenatmung. Diplomarbeit, Fachhochschule Gießen-Friedberg, Fachbereich KMUB, Wiesenstraße 14, 35390 Gießen.
- [15] WTW, BSB-Fibel, Grundlagen des BSB, Bestimmungsverfahren und ihre Leistungsfähigkeit, Verfahrenskenngrößen, WTW, Weilheim, FRG



**Wissenschaftlich-Technische
Werkstätten GmbH & Co. KG**

Dr. Karl-Slevogt-Straße 1

D-82362 Weilheim

Tel 0881 / 183-0

Fax 0881 / 6 25 39

E-Mail Info@WTW.com

Internet <http://www.WTW.com>

Prof. Dr. Harald Platen
Anna Wirtz

Fachbereich KMUB
Umwelt- und Hygienetechnik
und
Zentrum für Umwelttechnologie

Wiesenstrasse 14
D-35390 Giessen

Telephone and fax:
+49-641-3092533

e-mail:
harald.platen@tg.fh-giessen.de

Web site:
[http://www.fh-
giessen.de/WEB_TG/uht.htm](http://www.fh-giessen.de/WEB_TG/uht.htm)

Matrix: **Soils and solids**
Applications of analysis
no. 2

**Measurement of the
respiration activity of
soils using the
OxiTop® Control
measuring system**

Standard test preparation

1st edition, July 1999

Applications

Determination of the respiration activity of soils, composts, mud and all other solid materials in the measuring range of 1.5 to 1800 mg O₂/[kg*d] in the range of activities:

- Agricultural investigations
- Pollution investigations
- Waste investigations
- Basic research

Further information and references on this subject are given in the bibliography items, [1] - [12].

Measuring principle

Manometric measurement of oxygen consumption during the simultaneous absorption of CO₂ in caustic soda solution. Selection of a suitable measuring range through the use of measuring vessels of various sizes and different quantities of test material.

Material

OxiTop[®]-C heads (WTW, Weilheim, FRG)

OxiTop[®] OC 110 controller (WTW, Weilheim, FRG)

ACHAT OC PC communication software (WTW, Weilheim, FRG)

Data transmission cable, type AK 540/B for RS 232

Measuring vessel MG 1.0 and 1.5 with DV/MG lid-locking device (WTW, Weilheim, FRG)

Temperature-controllable room or temperature-controlled cabinet of the variants,

TS606/2....TS606-G4/Var (WTW, Weilheim, FRG)

Personal computer, minimum requirement: 80486 processor, 16 MB RAM, RS232 interface

Windows 3.1 or 3.11 operating system, EXCEL[®]5.0 spreadsheet program (Microsoft)

Laboratory balance (least reading: min. 0.1 g)

Beakers (50 mL)

Transfer pipette, 50 mL

Measuring cylinder, 50 mL

Caustic soda solution (1 mol/L)

Vaseline

Performing the measurement

Step no.	Step to be performed	Explanations, comments, notes
1	Adjust the material sample to be inspected to the optimum water content [1] required for inspection purposes Keep a part of the material for a dry substance determination [3]	In soils: usually half (50%) of the maximum water capacity. In composts: selection of the consistency according to rule of thumb [2]. Depending on the investigation, water contents deviating from this can be selected.
2	Determination of the amount of sample suitable for the test (100 to 300 g) Determination of the suitable measuring vessel (MG 1.0 or MG 1.5) For very low measuring ranges, a measuring vessel with a volume of 0.55 L can be used (Weck company, Öfringen, FRG) with, how-	The amount of sample and vessel size are determined afterwards depending on how high the respiration activity of the sample material is expected to be. For higher respiration rates, a reaction vessel that is as large as possible and an amount of sample that is as small as possible (see table 1) should be selected.

Step no.	Step to be performed	Explanations, comments, notes
	ever, a lid-locking device without a holder for the absorption vessel (For recommendations, see table 1)	For amounts of sample that are too low, the representativity of the sample will be lower.
3	Introduce the loosely packed material into the measuring vessel	
4	Thinly smear the sealing ring of the lid-locking device with Vaseline	Caution! Do not use silicon grease as this can cause damage if it comes into contact with the OxiTop® sensors
5	Insert the absorption vessel with 50 mL caustic soda solution (1M) into the holder of the lid-locking device	The concentration of CO ₂ absorber should be as low as possible due to changes in the dry substance (water loss). (Recommendation <2M)
6	Put on the lid and fasten it with the 4 clips (4x90°)	
7	Insert the rubber stopper	Do not grease this connection! If necessary, shorten the rubber stopper to be used as a seal!
8	Tightly screw on the OxiTop®-C sensor	Tighten it up carefully. Do not use force!
9	Bring the test preparation into the temperature constant room or thermostat cabinet	To ensure constant starting conditions or to avoid faulty measurements, it is recommended to pre-adjust the temperature of all the materials and components
10	Start recording the measured value by means of the controller in the "Pressure p" mode	The total measuring period depends on various factors. For natural soils, measuring periods of 7 days are recommended; However, no recommendation that is generally applicable can be given. 360 measured values are recorded at equidistant time intervals throughout the total measuring period
11	In order to prevent any oxygen limiting measuring conditions from occurring, the measured data of the sensors are transmitted to the controller at regular intervals. If a defined pressure value or if the selected warning pressure of, e.g. -100 hPa is undercut, the measuring vessels/samples must be treated, e.g. by ventilation, addition of nutrient solution, sample removal, new filling of CO ₂ absorber, etc. Before the beginning and after the end of the action, retrieve the instantaneous value and store it in the controller (max 10 instantaneous values M01...M10).	In the manometric /respirometric determination of the respiration activity, the oxygen partial pressure in the closed measuring vessel during the measurement decreases. If a minimum oxygen partial pressure is maintained, the biological activity of the microorganisms is not affected. The OxiTop-C® Control measuring system documents the entire pressure curve or oxygen consumption in the form of a graph.
12	If the pressure range mentioned above is undercut, the measuring vessel must be	This process can be repeated as often as required within the intended measuring pe-

Step no.	Step to be performed	Explanations, comments, notes
	opened and the caustic soda solution replaced.	ried, or over 10 storable instantaneous values, without having to restart the measuring sensor.
13	At the end of the measurement, the data are transmitted to a PC by means of the ACHAT OC software and edited using EXCEL.	The stored instantaneous values are listed at the end of the value table as M01 to M10 and can be displayed/evaluated as a continuous function by Excel (difference formation).

Table 1: Recommended vessel selection and amount of sample

Sample material	Recommended vessel volume	Recommended amount of sample
Soil, biologically not very active	1.0 L*)	300 g
Soil, biologically "normally" active	1.0 L	100 to 300 g
Soil after addition of lightly degradable material	1.5 L	100 g
Compost (biologically highly active)	1.5 L	50 g

*) If necessary, a special size of 0.55 L can be used with a lid-locking device without a holder for the absorption vessel

Examples of measuring results

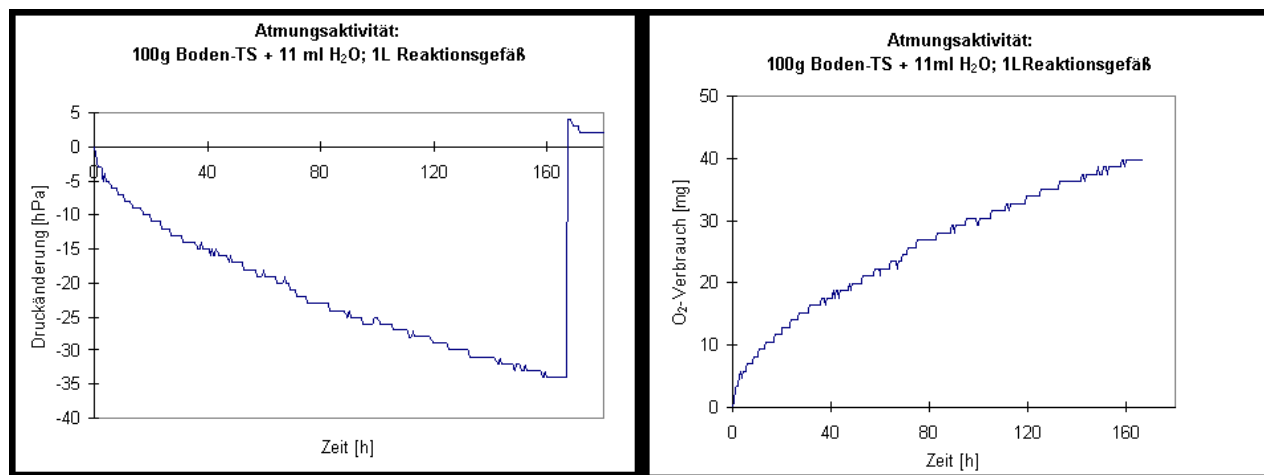

Figure 1: Determination of the respiration activity of a soil at 20°C. 100 g of the air-dried soil were brought to a water content of 50% of the WC_{max} by the addition of 11 mL tap water. The soil was placed in a reaction vessel of 1 L volume and the test performed according to the protocol mentioned above. The figure on the left shows the pressure curve recorded by the OxiTop® Control measuring system while the figure on the right shows the amount of oxygen consumed that was calculated from it. After 40 h, the oxygen consumption rate was approximately linear; for the subsequent period, an oxygen consumption rate of 42 mg O₂/[kg TS*d] was recorded.

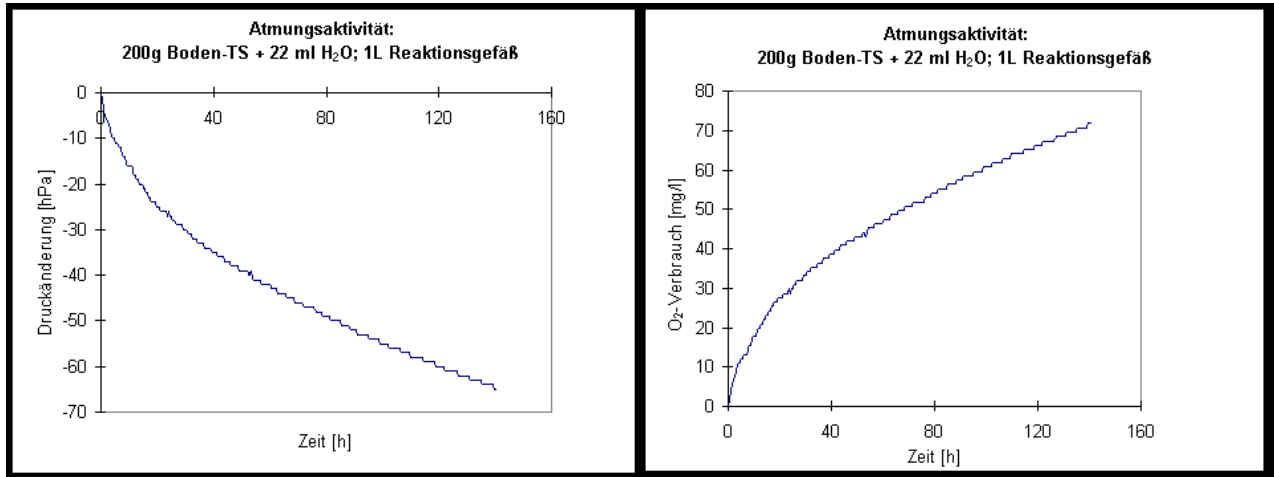
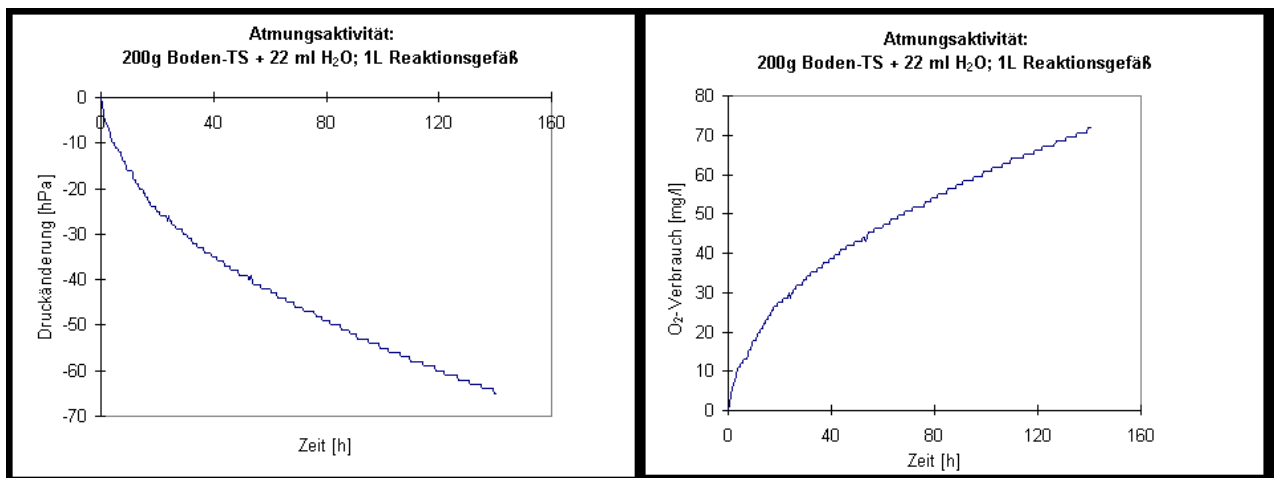

Figure 2: Determination of the respiration activity of a soil at 20°C. 200 g of the air-dried soil were brought to a water content of 50% of WC_{max} by the addition of 22 mL tap water. The soil was placed in a reaction vessel of 1 L volume and the test performed according to the protocol mentioned above. The figure on the left shows the pressure curve recorded by the OxiTop® Control measuring system while the figure on the right shows the amount of oxygen consumed that was calculated from it. After 60 h, the oxygen consumption rate was approximately linear; for the subsequent period, an oxygen consumption rate of 35 mg O₂/[kg TS*d] was recorded.



The same soil was used for both of the tests mentioned above. The results agree quite well within the framework of measuring tolerance. However, differences can be identified in the start phase (in the first 20 to 60 hours). How this should be evaluated is the object of further studies. For reasons of transparency, the start period (= lag phase) after which this was reached should be specified in addition to the measuring result of the respiration rate. The observation that a freshly moistened soil shows increased respiration activity in the first few hours is already described in the literature.

Bibliography

- [1] Platen, H., Wirtz, A. (1998). Applikationen zur Analytik Nr. 1: Bestimmung der Atmungsaktivität in Böden und anderen Feststoffen mit dem Meßsystem OxiTop®-Control - Grundlagen und Verfahrenskenngrößen-, 1. Auflage Fachhochschule Gießen-Friedberg, Wiesenstraße 14, 35390 Gießen.
- [2] Bundesgütegemeinschaft Kompost (Hrsg.; 1994). Methodenhandbuch zur Analyse von Kompost. Verlag Abfall, Stuttgart, FRG
- [3] DIN 38414 Teil 2 (1985). Bestimmung des Wassergehaltes und des Trockenrückstandes bzw. der Trockensubstanz. In. Deutsche Einheitsverfahren zur Wasser-, Abwasser- und Schlammuntersuchung, 15. Lieferung. VCH, Weinheim, FRG und Beuth-Verlag Berlin, FRG.
- [4] Sommer, I. (1996). Entwicklung und Prüfung eines neuen Meßsystems zur Bestimmung der Bodenatmung mit anschließenden Versuchen zur Korrelation mit der Mikroorganismenzahl. Diplomarbeit, Fachhochschule Gießen-Friedberg, Fachbereich KMUB, Wiesenstraße 14, 35390 Gießen.
- [5] Mößner, R. (1997). Weiterführende Untersuchungen zur Anwendbarkeit des OxiTop®-OECD-Meßsystems zur Bestimmung der Bodenatmung. Diplomarbeit, Fachhochschule Gießen-Friedberg, Fachbereich KMUB, Wiesenstraße 14, 35390 Gießen.
- [6] DECHEMA (1992). Labormethoden zur Beurteilung der biologischen Bodensanierung. 2. Bericht des interdisziplinären Arbeitskreises "Umweltbiotechnologie - Boden", Frankfurt, FRG
- [7] DECHEMA (1995). Biologische Testmethoden für Böden. 4. Bericht des interdisziplinären Arbeitskreises "Umweltbiotechnologie - Boden", Frankfurt, FRG
- [8] Platen, H., Bauer, S. (1996). Entwicklung der Bodenatmung in einem Ackerboden nach Kontamination mit Diesel im Laborversuch.. In. In-situ-Sanierung von Böden. 11. DECHEMA-Fachgespräch Umweltschutz, DECHEMA, Frankfurt, FRG: 229-239.
- [9] Isermeyer, H. (1952). Eine einfache Methode zur Bestimmung der Bodenatmung und der Karbonate im Boden. Z. Pflanzenern. Bodenk. **56**: 25-38
- [10] Alef, K. (1995). Soil respiration. In: Alef, K., Nannipieri, P. (eds.). Methods in applied soil microbiology and biochemistry. Academic Press, London, UK: 214-219.
- [11] VAAM (1994). Regeneration mikrobieller Aktivität in Böden nach natürlichen Streßsituationen - Bewertungskriterium für die Bodenqualität. BioEngineering **10** (6/94): 38-41.
- [12] Robertz, M., Eckl, S., Muckenheim, T., Webb, L. (1997). Kostengünstige Methode zur Bestimmung der Bodenatmung belasteter und unbelasteter Böden. Applikationsbericht AL 97004, Forschungszentrum Jülich, FRG.



**Wissenschaftlich-Technische
Werkstätten GmbH & Co. KG**

Dr. Karl-Slevogt-Straße 1

D-82362 Weilheim

Tel 0881 / 183-0

Fax 0881 / 6 25 39

E-Mail Info@WTW.com

Internet <http://www.WTW.com>

Prof. Dr. Harald Platen
Anna Wirtz

Fachbereich KMUB
Umwelt- und Hygienetechnik
und
Zentrum für Umwelttechnologie
Wiesenstrasse 14
D-35390 Giessen

Telephone and fax:
+49-641-3092533

e-mail:
harald.platen@tg.fh-giessen.de

Web site:
http://www.fh-giessen.de/WEB_TG/uht.htm

Matrix: Soils and solids
**Applications of analysis
no. 3**

**Measurement of lower
respiration activity of
soils using the
OxiTop® Control
measuring system**

1st edition, July 1999

Applications

Determination of the respiration activity of soils and other solid materials in the lower measuring range of up to 1.5 O₂/[kg*d] in the range of activities:

- Agricultural investigations
- Pollution investigations
- Waste investigations
- Basic research

Further information and references on this subject are given in the bibliography items, [1] - [12].

Measuring principle

Manometric measurement of oxygen consumption during the simultaneous absorption of CO₂ in caustic soda solution. Sensitive measurement by selection of a small measuring vessel (550 mL) with a larger quantity of soil (up to 400 g).

Material

OxiTop[®]-C heads (WTW, Weilheim, FRG)

OxiTop[®]OC 110 controller (WTW, Weilheim, FRG)

ACHAT OC PC communication software, (WTW, Weilheim, FRG)

Data transmission cable, type AK 540/B for RS 232 (WTW, Weilheim, FRG)

DV/MG lid-locking device (WTW, Weilheim, FRG)

Measuring vessel, 0.55 L (single-trip, Weck company, Wöhr-Öflingen, FRG)

Temperature-controllable room or temperature-controlled cabinet of the variants,

TS606/2....TS606-G4/Var (WTW, Weilheim, FRG)

Personal computer, minimum requirement: 80486 processor, 16 MB RAM, RS232 interface

Windows 3.1 or 3.11 operating system

EXCEL[®] software (Microsoft, USA)

Laboratory balance (least reading: min. 0.1 g)

Absorption vessel (50 mL)

Transfer pipette, 50 mL

Measuring cylinder, 50 mL

Caustic soda solution (1 M)

Vaseline

Performing the measurement

Step no.	Step to be performed	Explanations, comments, notes
1	Adjust a sufficient quantity of the soil sample to be inspected to the optimum water content [1] required for inspection purposes. Keep a part of the material for a dry substance determination [2].	In soils: usually half of the maximum water capacity [1] is selected. Depending on the investigation, water contents deviating from this can be selected.
2	Determination of the amount of sample suitable for the test (100 to 400 g) Single-trip beakers of the Weck company (0.55 L) are used as the measuring vessels; The holder for the absorption vessel is unscrewed from the DV/MG lid-locking device.	The DV/DG lid-locking device has a standard design for the vessel sizes, 1.0 and 1.5 L. After dismantling the holder for the absorption vessel, the lid can also be used for smaller vessels.

Step no.	Step to be performed	Explanations, comments, notes
3	Insert the absorption vessel with 50 mL caustic soda solution (1 M) into the measuring vessel.	
4	Introduce the loosely packed soil into the measuring vessel around the absorption vessel	The absorption vessel should not be placed on the soil so that it does not become compacted.
5	Lightly smear the sealing ring of the lid-locking device (without the holder for the absorption vessel) with Vaseline	Caution! Do not use silicon grease as this can cause damage to the OxiTop® sensors if they come into contact.
6	Replace the lid and fasten it with the 4 clips (4x 90°)	
7	Insert the rubber stopper.	Do not lubricate the connection! If necessary, cut the rubber stopper to length to be used as a seal!
8	Tightly screw on the OxiTop®-C sensor	Do not use force!
9	Introduce the sample preparation in the constant temperature chamber or temperature-controlled cabinet	To avoid faulty measurements, the temperature of all the materials should be pre adjusted.
10	Start recording the measured value by means of the OC110 controller ("Pressure p" mode)	The total measuring time depends on various factors. The lower the respiration rate, the longer the measuring time should be. 360 measured values are recorded at equidistant time intervals throughout the total measuring period.
11	In order to prevent any oxygen limiting measuring conditions from occurring, transmit the measurement data of the sensors to the controller at regular intervals. If a defined pressure value or if the selected warning pressure of, e.g. -100 hPa is undercut, the measuring vessels/samples must be treated, e.g. by ventilation, addition of nutrient solution, sample removal, new filling of CO ₂ absorber, etc. Before the beginning and after the end of the action, retrieve the instantaneous value and store it in the controller (max. of 10 instantaneous values M01...M10)	In the manometric /respirometric determination of the respiration activity, the partial oxygen pressure in the closed measuring vessel during the measurement decreases. If a minimum partial oxygen pressure is maintained, the biological activity of the microorganisms is not affected. The OxiTop-C® Control measuring system documents the entire pressure curve or oxygen consumption in the form of a graph.
12	If the pressure range mentioned above is undercut, the measuring vessel should be opened and the caustic soda solution replaced.	This process can be repeated as often as required within the intended measuring period, or over 10 storable instantaneous values, without having to restart the measuring sensor.
13	At the end of the measurement, the data are transmitted to a PC by means of the ACHAT OC software and processed using EXCEL for data presentation.	The stored instantaneous values are listed at the end of the value table as M01 to M10 and can be displayed/evaluated as a continuous function by Excel (difference formation).

Examples of measurement results

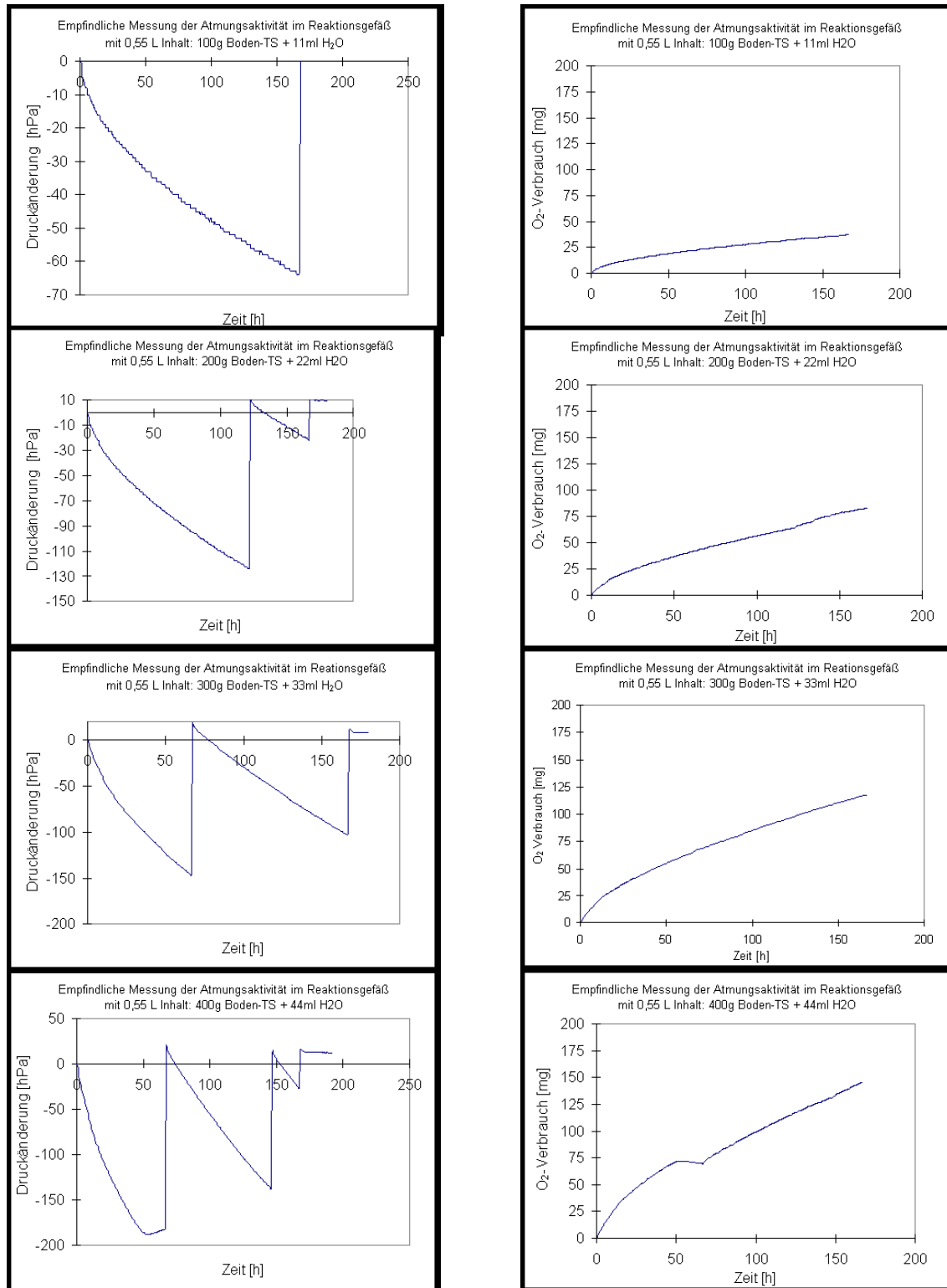

Figure 1: Measurement of the respiration activity of a soil at 20°C in a 0.55 L measuring vessel.

Left column: Measured value recorded by the OxiTop[®] control measuring system.

Right column: Data prepared by Excel.

The weighed quantity of soil (100, 200, 300 and 400 g TS each with 10% water content) increases from top to bottom. Further explanations are given in the text.

All the figures show that, immediately after the start of the measurements, the activity of the soil is higher than after 50 to 100 h where the respiration activity approaches a constant value (see 11). After this time, the respiration activity is calculated by applying the tangent. The specific respiration rate with reference to the amount of soil is given for the measuring preparations of 31.8, 40.6, 42.4 and 45.0 mg O₂/[kg*d] respectively. Apart from the initial measured value, these lie quite close to one another. The measurements indicate – within the framework of the uncertainty of measurement – a linear relationship between the amount of soil and the respiration rate. This also shows that the respiration rate can be measured independently of the thickness of the layer of soil. Assuming that the soil sample is not too heavily compressed, the gas exchange is not affected to any great extent by the thickness of the layer!

In measuring preparations with 400 g soil, the oxygen was completely consumed after 3 days; After that, a light increase in pressure occurred indicating the formation of a gas. The nature of the gas was not investigated (the formation of methane is unlikely). Immediately after ventilation and replacement of the caustic soda solution, respiration activity of the same rate continued to be measured.

Bibliography

- [1] Platen, H., Wirtz, A. (1998). Applikationen zur Analytik Nr. 1: Bestimmung der Atmungsaktivität in Böden und anderen Feststoffen mit dem Meßsystem OxiTop®-Control - Grundlagen und Verfahrenskenngrößen Fachhochschule Gießen-Friedberg, Wiesenstraße 14, 35390 Gießen. 1. Auflage
- [2] Platen, H., Wirtz, A. (1998). Applikationen zur Analytik Nr. 2: Bestimmung der Atmungsaktivität von Böden und Feststoffen mit dem Meßsystem OxiTop®-Control Standardprüfansatz. Fachhochschule Gießen-Friedberg, Wiesenstraße 14, 35390 Gießen. 1. Auflage
- [3] DIN 38414 Teil 2 (1985). Bestimmung des Wassergehaltes und des Trockenrückstandes bzw. der Trockensubstanz. In: Deutsche Einheitsverfahren zur Wasser-, Abwasser- und Schlammuntersuchung, 15. Lieferung. VCH, Weinheim, FRG und Beuth-Verlag Berlin, FRG.
- [4] Sommer, I. (1996). Entwicklung und Prüfung eines neuen Meßsystems zur Bestimmung der Bodenatmung mit anschließenden Versuchen zur Korrelation mit der Mikroorganismenzahl. Diplomarbeit, Fachhochschule Gießen-Friedberg, Fachbereich KMUB, Wiesenstraße 14, 35390 Gießen.
- [5] Mößner, R. (1997). Weiterführende Untersuchungen zur Anwendbarkeit des OxiTop®-OECD-Meßsystems zur Bestimmung der Bodenatmung. Diplomarbeit, Fachhochschule Gießen-Friedberg, Fachbereich KMUB, Wiesenstraße 14, 35390 Gießen.
- [6] DECHEMA (1992). Labormethoden zur Beurteilung der biologischen Bodensanierung. 2. Bericht des interdisziplinären Arbeitskreises "Umweltbiotechnologie - Boden", Frankfurt, FRG
- [7] DECHEMA (1995). Biologische Testmethoden für Böden. 4. Bericht des interdisziplinären Arbeitskreises "Umweltbiotechnologie - Boden", Frankfurt, FRG
- [8] Platen, H., Bauer, S. (1996). Entwicklung der Bodenatmung in einem Ackerboden nach Kontamination mit Diesel im Laborversuch.. In: In-situ-Sanierung von Böden. 11. DECHEMA-Fachgespräch Umweltschutz, DECHEMA, Frankfurt, FRG: 229-239.
- [9] Isermeyer, H. (1952). Eine einfache Methode zur Bestimmung der Bodenatmung und der Karbonate im Boden. Z. Pflanzenern. Bodenk. **56**: 25-38
- [10] Alef, K. (1995). Soil respiration. In: Alef, K., Nannipieri, P. (eds.). Methods in applied soil microbiology and biochemistry. Academic Press, London, UK: 214-219.
- [11] VAAM (1994). Regeneration mikrobieller Aktivität in Böden nach natürlichen Streßsituationen - Bewertungskriterium für die Bodenqualität. BioEngineering **10** (6/94): 38-41.
- [12] Robertz, M., Eckl, S., Muckenheim, T., Webb, L. (1997). Kostengünstige Methode zur Bestimmung der Bodenatmung belasteter und unbelasteter Böden. Applikationsbericht AL 97004, Forschungszentrum Jülich, FRG.