

LAQUA

Touchscreen precision.
The new benchmark.



pH	ORP	ION	Conductivity
Resistivity	Total Dissolved Solids	Salinity	

Benchtop Water Quality Meters

F-70/DS-70 Series





Ideas for you

Our concept originated from you

“Meters and electrodes become dirty so often, I wish I could keep them clean all the time.”

“It would be great if I could quickly visualize the calibration and measurement results, as well as the status of the electrodes.”

“If a problem occurs, I want it solved immediately!”

“It’s a pain to have to look through the instruction manual.”

“Electrode stands are actually not that user-friendly.”

“I want the electrode stand to move freely according to the location and what I’m using it for.”

“Robust with high precision.”

“Which electrode actually matches my need?”

“I want stable measurements every day.”

We listened closely to each of our customers’ comments, and applied what we heard to our next generation analyzer. HORIBA is proud to announce LAQUA, the water quality analyzer that answers all of your needs.



LAQUA

- ▶ Stress free operation / Smart navigation P03~05
- ▶ Essence of technology P06~08
- ▶ Product selection guide and packages P09~10

Intuitive and easy to use touch panel operation

Intuitive control with the large capacitive touch panel. Smart navigation provides step-by-step guidance for trouble-free operation. Easy to clean glass top and round body, LAQUA is both easy and fun to use!

SMART

Operation buttons are reduced to the bare minimum

CAL

MEAS

DATA



Calibration

Measurement

Data Management



Simply slide your finger across the screen to switch displays

Switch between digital, graphic, and analog displays during measurement with just the flick of a finger. No need for complex actions.

2-channel simultaneous measurement and display

pH value and a second measurement (such as ORP, ion, electrical conductivity) can be displayed simultaneously.



Digital



Graph



Analog

Accurate calibration for measurement precision.

Correct calibration is done under "stable" conditions. Calibration performed under unstable conditions is one of the big causes of measurement error. Calibration response is visualized as numerical data or a graph. With LAQUA, you are sure about your calibration validity

Calibration Assistance Function

You can tell measurement value has stabilized when the graph has stabilized and the calibration stability values become smaller. "Stability" checking at a glance!

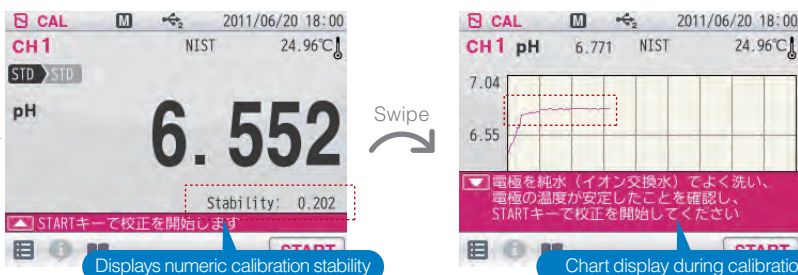

NAVIGATION

Experience LAQUA on the WEB

www.horiba.com/laqua

Enjoy hassle-free operation with on-screen settings confirmation, maintenance information, and troubleshooting tips

Inspection Navigation

Easy navigation for meter and electrode inspections. Various industrial standards (JIS, USP, EP, JP, CP) are also supported.

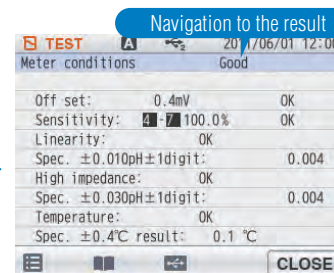

Troubleshooting Navigation

On-screen support for resolving a problem that occurs during calibration or sample measurements. A user's guide is incorporated in the software to assist with any operational difficulties.

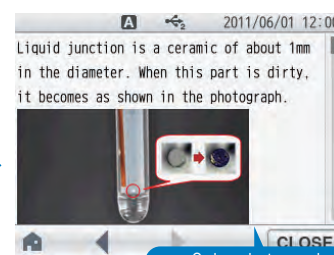
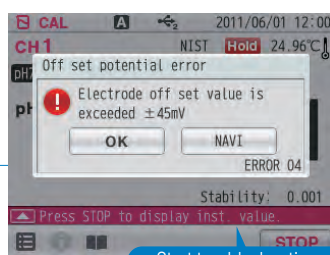

Application Functions

Various industry standard methods are supported by the instrument. Conductivity measurement for several country pharmaceutical pure water guidelines are incorporated with the meter.

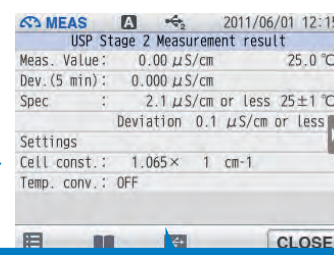
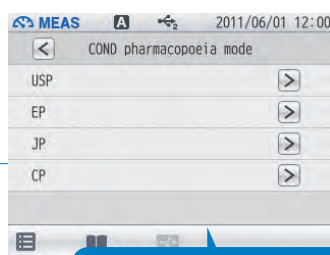

Full-Range of Functions for Validation and Usability

(For compatible models please see the P14 body specification.)

- Customizable auto hold function for calibration and measurement
- Periodic inspection mode: JIS/Pharmacopoeias/Digital Simulator
- Digital memory: Maximum 2,000 sets of measurement data can be recorded (999 sets for F-71/F-74BW/DS-71 models)
- Simultaneous connection to a GLP/GMP compatible printer and PC
- Customizable print function
- Save data onto a USB flash drive
- USB PC Communication: Data storage software available as a free download for registered users.
- Multi-language support (Japanese, English, Chinese, Korean)
- FDA21CFR Part 11 (Please ask for quotation)

LAQUA's free arm electrode stand can handle any container size or position.

The stand-alone free arm electrode stand can be moved wherever you like, vertically or horizontally.

You can also use the long electrode stand* with a telescopic shaft when working with large beakers.

360°

The 360° rotating free arm also has a full range of vertical movement.

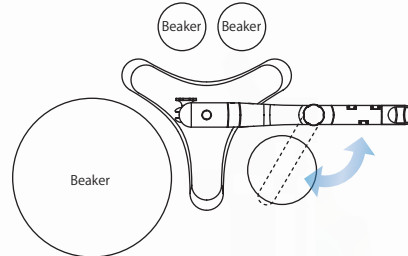

The full range of standard movements lets you arrange a variety of large and small containers wherever you please.

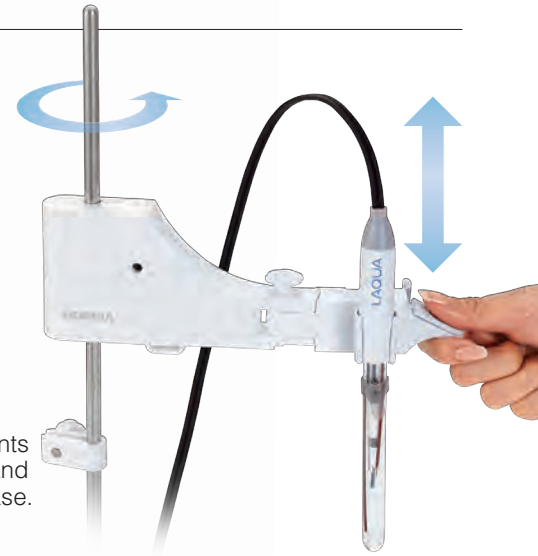

450~650mm

The long electrode stand* has a maximum length of 650mm. It can also be stored neatly thanks to the telescopic shaft.

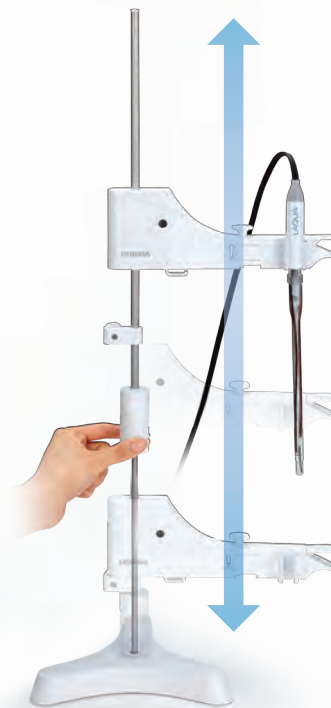

With the long electrode stand*, you can prepare small quantities of standard solution for calibration or large capacity containers of buffer solution without having to detach and reattach the electrodes.

*Optional

HORIBA electrode technology gives you the fusion of high accuracy and ease of use

ELECTRODE

HORIBA electrode is now even tougher and responds faster.



Enhanced stability and minimized drift

Integrating two new technologies for faster response times and optimal performance.

01 pH fast response glass membrane (U.S. Patent No. 8262877)

New technology

The membrane contains HORIBA's unique combination of rare earth metals to improve response time by twofold and to increase durability against chemical attack.

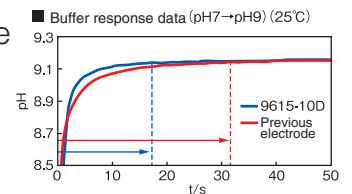

02 Reference electrode with increased stability (Patent pending)

New technology

Covering the internal electrode with a cation-conductive hollow fiber membrane, liquid junction clogging by silver ions and silver complex ions is reduced to 1/1000 of the conventional technology. Furthermore, maintained internal solution concentration ensures a stable standard electrical potential.

Tough electrodes are now even stronger

HORIBA's glass membrane molding technology achieves strengths more than 10 times the Japanese Industrial Standards (strength tests).

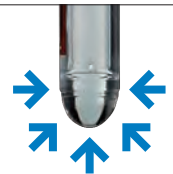

New dome-shaped construction boosts strength in all directions!

Not just “unbreakable.” New flat sensor innovations allow the measurement of trace sample droplets or the measurement of solid sample surface.



What is an ISFET(semiconductor sensor)?

ISFET is the abbreviation of Ion Sensitive Field Effect Transistor. The response membrane is equipped with semiconductor based sensor.

ISFET features

1. Will not crack or break like conventional glass electrodes
2. The sensor is flat and very small in size, enabling the measurement of extremely small samples
3. Easy handling and maintenance – simply clean with a toothbrush
4. Can be stored dry

The flat electrode has less than 100µm distance between the housing and the sensor.

The unique structure enables to measure minuscule amount of moisture on the surface of solid objects and prevents bubbles from trapping on the sensor when measuring samples in a beaker.

Effects of static electricity is reduced

The combination of HORIBA's unique semiconductor device construction and improved static protection circuit means that the effects of static electricity, once the Achilles heel of semiconductor sensors, are greatly reduced.

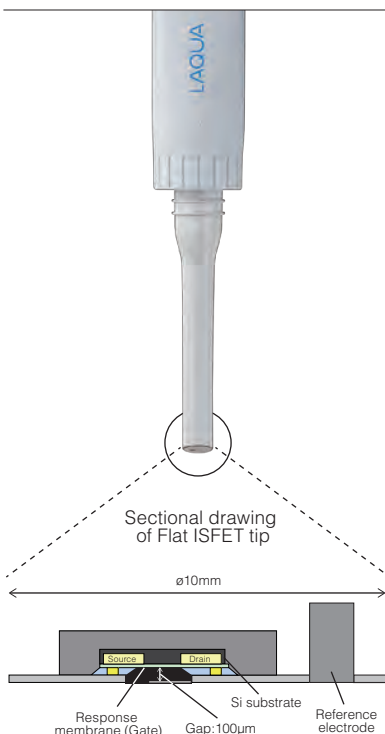

New • pH electrode

Precision—pH electrodes from HORIBA which answers your needs.

Stable measurement for a wide range of samples. Standard **Tough** electrode (9615-10D)

STANDARD Tough  



High stability and drift reduction. No more worries about the timing of your measurement value readings.

- Uses responsive glass that is 10 times stronger than JIS standard. The domed shape provides strength in all directions, greatly reducing damage concerns.
- Constructed with smooth surfaces for easy wiping and cleaning.

Recommended

Perfect for preparing buffers. Can be used on a wide range of aqueous test solutions.

For extremely small samples Micro **Tough** electrode (9618-10D)

MICRO Tough 



This pH electrode with temperature compensation sensor can take measurements from samples as small as 50 μ L, the smallest in the world.

- Our original manufacturing technology (Japanese Patent No. 4054245) is used to produce 2-ply piping 3mm in diameter.
- Compatible with extremely small containers such as micro tubes etc.
- The temperature sensor is located at the tip for high-speed temperature response. Refrigerated samples can be measured without needing to wait for them to return to room temperature.

Recommended

Can be used for a wide range of aqueous solutions, including those that cannot be obtained in large quantities. We recommend using our specialized cleaning solution after measuring samples that contain proteins.



For using a large container Long **Tough** electrode (9680-10D)

LONG Tough  



283 mm length & 8 mm diameter. The long, thin design makes this electrode perfect for measuring in large containers and test tubes.

- Uses responsive glass that is 10 times stronger than JIS standard. The domed shape provides strength in all directions, greatly reducing damage concerns.

Recommended

For measuring samples such as microbe culture fluids in test tubes. We recommend that it be used with the long type electrode stand (FA-70L).



For highly viscous samples Sleeve **Tough** electrode (9681-10D)

SLEEVE Tough  



Stable measurement can also be achieved for high viscous samples.

- The liquid junction section is constructed with a moveable sleeve that can be rinsed clean, preventing highly viscous samples from clogging the liquid junction, and maintaining stable measurement performance

Recommended

For highly viscous samples and solutions, and samples that contain non-aqueous solvents (such as cosmetics or paints). We recommend that you take measurements while using the graph display function to confirm stable responses. (We recommend washing with a neutral detergent after use with samples that contain oil.)

For the surface of solid samples Flat ISFET pH electrode (0040-10D)

FLAT ISFET 



The sensor is located on the flat surface of the electrode tip, with less than a 100 μm protrusion from the housing.

- Measurements can be made from a minute amount of moisture on the solid sample surface.
- Use of a semiconductor sensor means there are no concerns that the electrode will be damaged.
- Also perfect for measuring samples in shallow containers such as Petri dishes.
- Replaceable sensor

Recommended

For surface measurement of gelatinous materials such as nutrient agar, and food samples such as meat. Evaluation of sheet materials such as cloth or paper. (If the sample only has a small amount of moisture, pure water etc. is required. We recommend washing with a neutral detergent after use with samples that contain oil.)

For easy and safe measurement inside solid samples (0030-10D)

NEEDLE ISFET 



The sharp tip can pierce solid material to take measurement within the sample.

- Use of a semiconductor sensor means there are no concerns that the electrode will be damaged.
- Replaceable sensor

Recommended

For measuring inside foodstuffs, such as fruits, vegetables and bread. (We recommend washing with a neutral detergent after use with samples that contain oil.)

For stable measurement of tap water Low conductivity/Low buffer capacity pH electrode (9630-10D)

For TAP WATER  



Using the high-purity glass membrane, faster stable measurement is possible at a low electrical conductivity and low buffer capacity sample

- It enables the measurement within 90 seconds measurement (Auto hold) for tap water by using the conditioning liquid(model name 230). (95% Response is within 60 seconds)

Recommended

It is ideal for water quality testing in the water purification plant.

A meter to match your every need.

meter + electrode set

What do you measure?
First, select a meter.

(Meter accessories: User's Manual, Quick Guide, power adaptor, electrode stand)

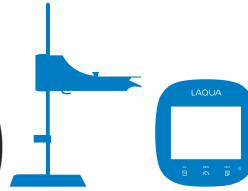

Line-up of electrodes based on various applications.

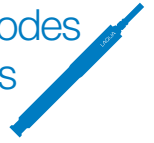

pH Meters



F-71

CH.1 pH ORP

PC PRT ID

pH-Ion Meters



F-72

CH.1 pH ORP
ION

PC PRT ID

NAVI USB

COLOR LCD



F-73

CH.1 pH ORP
ION

CH.2 pH ORP
ION

NAVI 2CH USB

PC PRT ID

COLOR LCD

Conductivity Meters



DS-71

COND RESI
SAL TDS

PC PRT ID



DS-72

COND RESI
SAL TDS

NAVI USB PC

ID PRT

USP/EP/JP

COLOR LCD

Multi-Parameter Meters



F-74BW

CH.1 pH ORP
ION

CH.2 COND RESI
SAL TDS

PC PRT ID

2CH



F-74

CH.1 pH ORP ION

CH.2 COND RESI
SAL TDS







NAVI 2CH USB PC

PRT ID USP/EP/JP



COLOR LCD

Accessories included : Electrode stand/Instruction manual/Quick manual/AC adaptor

pH Electrodes

- Standard ToupH electrode 9615-10D  Pb Free WATER PROOF
- Micro ToupH electrode 9618-10D  WATER PROOF
- Long ToupH electrode 9680-10D  Pb Free WATER PROOF
- Sleeve ToupH electrode 9681-10D  Pb Free WATER PROOF
- HF acid resistant pH electrode 9631-10D  Pb Free WATER PROOF
- Alkali resistant pH electrode 9632-10D  Pb Free WATER PROOF
- Tap water pH electrode 9630-10D  Pb Free WATER PROOF



ISFET

- Flat ISFET pH electrode 0040-10D  WATER PROOF
- Needle ISFET pH electrode 0030-10D  WATER PROOF







ORP electrode

- Metallic electrode platinum 3-in-1 type 9300-10D  WATER PROOF

Electrical conductivity cell

- Immersion type 3552-10D  WATER PROOF
- Immersion type 9382-10D  WATER PROOF

ION Selective (Combination type)

- Chloride Ion 6560-10C Cl⁻ 
- Fluoride Ion 6561-10C F⁻ 
- Ammonia 5002A-10C NH₄⁺ 
- Nitrate Ion 6581-10C NO₃⁻ 
- Potassium Ion 6582-10C K⁺ 
- Calcium Ion 6583-10C Ca²⁺ 

NAVI Navigation Function
 2CH 2-channel measurement
 USB USB flash drive compatible
 PC PC connection* compatible (USB)
 PRT Printer output compatible (printer sold separately)
 ID Security function
 COLOR LCD Color LCD touch panel display
 USP/EP/JP Conductivity measurements stipulated under various countries

Recommended Packages

(Complete sets with meter, electrode, and standard solutions)



Custom LCD



F-71A-S

Benchtop pH / ORP Custom LCD Meter Set, complete with

- electrode stand
- glass pH electrode (9615-10D)
- pH 4/7/10 buffers & 3.33M KCl reference electrolyte (502-S)



DS-71A-S

Benchtop Conductivity / Resistivity / Salinity / TDS Custom LCD meter, complete with

- electrode stand
- conductivity electrode (3552-10D)
- conductivity standard solutions 84 uS, 1413 uS, 12.88 mS & 111.9 mS (503-S)



F-74BW-A-S

Benchtop pH / ORP / ION / Conductivity / Resistivity / Salinity / TDS Custom LCD meter complete with

- electrode stand
- glass pH electrode (9615-10D)
- pH 4/7/10 buffers & 3.33M KCl reference electrolyte (502-S)
- conductivity electrode (3552-10D)
- conductivity standard solutions 84 uS, 1413 uS, 12.88 mS & 111.9 mS (503-S)

Touch Screen Color LCD



F-72A-S

Benchtop pH / ORP / ION Color Touch Screen Meter Set, complete with

- electrode stand
- glass pH electrode (9615-10D)
- pH 4/7/10 buffers & 3.33M KCl reference electrolyte (502-S)



F-73A-S

Benchtop pH / ORP / ION, Dual Channel Color Touch Screen Meter set, complete with

- electrode stand
- glass pH electrode (9615-10D)
- pH 4/7/10 buffers & 3.33M KCl reference electrolyte (502-S)



DS-72A-S

Benchtop Conductivity / Resistivity / Salinity / TDS Color Touch Screen meter, complete with

- electrode stand
- conductivity electrode (3552-10D)
- conductivity standard solutions 84 uS, 1413 uS, 12.88 mS & 111.9 mS (503-S)



F-74A-S

Benchtop pH / ORP / ION / Conductivity / Resistivity / Salinity / TDS Color Touch Screen meter complete with

- electrode stand
- glass pH electrode (9615-10D)
- pH 4/7/10 buffers & 3.33M KCl reference electrolyte (502-S)
- conductivity electrode (3552-10D)
- conductivity standard solutions 84 uS, 1413 uS, 12.88 mS & 111.9 mS (503-S)

pH Electrode Selection Guide

		3-in-1 ELECTRODES (ToupH)					ISFET ELECTRODES		3-in-1 ELECTRODES	
		PLASTIC	STANDARD ToupH	LONG ToupH	MICRO ToupH	SLEEVE ToupH	NEEDLE ISFET	FLAT ISFET	SLEEVE	NON-AQUEOUS
		9625-10D	9615-10D	9680-10D	9618-10D	9681-10D	0030-10D	0040-10D	6367-10D	6377-10D
Specification	Applicable temperature range (°C)	0-100	0-100	0-100	0-60	0-60	0-60	0-60	0-60	0-60
	Diameter (mm)	16	12	8	3	12	15	10	12	12
	Position of liquid junction (approx. mm)	15	13	21	6	26	11	0.1	10	23
	Length (mm)	150	198	283	185	203	190	190	150	150

pH - Sample Conditions

Aqueous Solution	Conductivity	Normal (over 100 mS/m)	●	●	●	●	●	●	●	●
		Low (approx. 10 ~100 mS/m)					○			●
		Very low (approx. 5 ~100 mS/m)					○			●
		High (approx. 5 S/m)	○	○	○		●			
	Strong alkaline (pH 10-12)		○	○		○			○	
	Strong acidity (pH 0-2) * Except HF sample		●							
	Quick heat change (within 50°C)	●								
	High viscosity (approx. 5 Pa·S)					●			○	●
Solid/Semisolid	Containing non-aqueous solvent		○	○	○	○	○	○	○	●
	Suspension		○	○	○	●	○	○		●
	Inside						●			
	Surface							●		

pH - Sample Conditions

Sample Containers	Microtube/plate (> 50 µL)	×	×	×	●	×	×	×	×	×
	NMR tube	×	×	×	×	×	×	×	×	×
	Ampule				●					
	Micro container (> 2 mL)			○	●					
	Tube			●						
	Beaker	●	●	○	○	○	○	○	○	○
	Large container (> 1 L)	○	○	●						
	Petri dish							●		
Droplet	×	×	×	×	×	×	●	×	×	

pH - Typical Samples

Water	Pure/ion-exchange water (approx. 0.1 mS/m)									●
	Distilled water (approx. 0.5 mS/m)		○							●
	Tap/drinking water (approx. 10 mS/m)	○	○			○				●
	Surface water		○			○				●
	Pharmaceutical water		○			○				○
Chemical reagent/solvent	Enviromental water/acid rain	○	○			○				○
	Caustic/strong acid (Except HF sample)		●			○				
	Hydrofluoric acid									
	Organic solvent	×					×	×		○
	KCl-reactive solution	×	×	×	×	×	×	×	×	×
	Surfactant		○			●				○
Pharmaceutical/biology sample	Water-based paint		○			●				○
	Dye/coloring agent					●				○
	Protein-containing sample		○		○	●			○	
	Medicinal preparation				○	○				○
	Enzyme solution			○	●					
	Tris buffer		●		○	○				
Food	Suspension		○			●				●
	Agar medium							●		
	Jam		○			●	● (inside)	● (surface)		○
	Meat/fish						● (inside)	● (surface)		
	Fruit/vegetable						● (inside)	● (surface)		
	Dough						● (inside)	● (surface)		
	Honey						○ (inside)	○ (surface)		●
Beverage/seasoning	Cheese/butter						● (inside)	○ (surface)		
	Yogurt	○	○			○	● (inside)	● (surface)	○	
	Beer	○	○			●			○	●
	Milk		○			●			○	○
Cosmetic/lotion	Carbonated drink/juice/sauce/soy sauce		○			●			○	○
	Mayonnaise/ketchup		○			●				○
	Beauty cream/mascara		○			●	○			○
Cosmetic/lotion	Gel/soap/shampoo		○			●				○
	Hairdye lotion		○			●				○
	Emulsified liquid		○			○				●

● Recommended ○ Can be measured × Prohibited or risk of damage

Electrodes/Accessories

For LAQUA/LAQUA^{act}



pH Electrode

	Description	Model	Temp. range (°C)	pH range	Part No.
Combination (3-in-1) pH electrode	Plastic body	9625-10D	0~100 ¹	0~14	3200360505
	Standard ToupH	9615-10D	0~100	0~14	3200366539
	Sleeve ToupH	9681-10D	0~60	0~14	3200366572
	Long ToupH	9680-10D	0~100 ¹	0~14	3200366560
	Micro ToupH	9618-10D	0~60	0~14	3200366552
	Sleeve	6367-10D	0~60	0~14	3014079136
	For measurement of low-conductivity water and non-aqueous solvents	6377-10D	0~60	0~14	3014093085
	Needle type	6252-10D	0~60	0~12	3014080850
	For Tap water	9630-10D	0~100	0~14	3200528726
	For Hydrofluoric acid sample	9631-10D	0~60	2~12	3200524119
	For Strong alkali sample	9632-10D	0~100	0~14	3200524120
ISFET pH electrode	Needle type ISFET	0030-10D	0~60	0~14	3014028323
	Flat type ISFET	0040-10D	0~60	0~14	3200367925
	Needle type ISFET(0030-10D) sensor	0131	0~60	0~14	3014028400
	Flat type ISFET(0040-10D) sensor	0141	0~60	0~14	3200367926
Combination pH electrode	For very slender test tubes	6069-10C	0~60	0~14	3014081107
	Flat type	6261-10C	0~50	0~12	3014081807
Glass pH electrode	Standard type	1066A-10C	0~100	0~14	3014080432
	For measurement of low-conductivity water and non-aqueous solvents.	1076A-10C	0~100	0~14	3014093084
Reference electrode	Standard type	2060A-10T	0~100	—	3014080434
	Double-junction type	2565A-10T	0~100	—	3014080436
Temperature electrode	For temperature compensation and measurement	4163-10T	0~100	—	3014080375
ORP electrode	Platinum 3-in-1 type	9300-10D	0~60	—	3014046710

Conductivity Cell

- Conductive material: Platinum rings coated with platinum black
- Body housing: Glass except 9382-10D - Plastic

Cell constant cm ⁻¹ (m ⁻¹)	Model	Range cm ⁻¹ (m ⁻¹)	Minimum Volume (mL)	Application	Temp. range (°C)	Part No.	
Immersion type	0.1 (10)	3551-10D	0.1 μS~10 mS (10 μS~1 S)	50	For low conductivity water (deionized water or other)	0~60	3014081712
	1 (100)	9382-10D	1 μS~100 mS (0.1 mS~10 S)	20~30	Waterproof. For general purposes	0~80	3014046709
	1 (100)	3552-10D	1 μS~100 mS (0.1 mS~10 S)	15	For general purposes	0~100	3014081545
	10 (1000)	3553-10D	10 μS~1 S (1 mS~100 S)	50	For high conductivity water	0~60	3014081714
Flow type	0.1 (10)	3561-10D	0.1 μS~10 mS (10 μS~1 S)	10	For low conductivity water (pure water or other)	0~60	3014082350
	1 (100)	3562-10D	1 μS~100 mS (0.1 mS~10 S)	16	For general purposes	0~60	3014082513
	10 (1000)	3573-10C	10 μS~1 S (1 mS~100 S)	4	For high conductivity water	0~60	3014082590
	10 (1000)	3574-10C	10 μS~100 mS (1 mS~10 S)	0.25	For column chromatography using a very small amount of sample	0~60	3014082592

Ion Selective Electrode

- All ion electrodes (except combination electrodes) require a sensor holder for attaching to the electrode stand.
- Please be aware of the hindering ion and pH range interference of ion electrodes. • D-73 connects combination type ion electrodes only.

Replacement Tip

Electrode name	Model	Measuring range	Interfering ion influence ^{*1}	Part No.	Model	Part No.
Combination Chloride ion electrode*	6560-10C	0.4~35,000 mg/L Cl ⁻	Br=0.03 NO ₃ ⁻ , F ⁻ , HCO ₃ ⁻ , SO ₄ ²⁻ , PO ₄ ³⁻ =1,000	3014093430	7660	3014093436
Combination Fluoride ion electrode*	6561-10C	0.02~19,000 mg/L F ⁻	(ex. Al ³⁺ , Fe ³⁺)coexisted and foamed the complex.	3014093431	7661	3014093438
Combination Nitrate ion electrode*	6581-10C	0.62~62,000 mg/L NO ₃ ⁻	CH ₃ COO ⁻ =300 SO ₄ ²⁻ =Over 1000	3014093432	7681	3014068364
Combination Potassium ion electrode*	6582-10C	0.04~39,000 mg/L K ⁺	Li ⁺ , Na ⁺ , Mg ²⁺ , Ca ²⁺ , Sr ²⁺ , Ba ²⁺ =Over 1000	3014093433	7682	3014069795
Combination Calcium ion electrode*	6583-10C	0.4~40,080 mg/L Ca ²⁺	Mn ²⁺ =500 Mg ²⁺ =1,000 Na ⁺ , K ⁺ , Ba ²⁺ , NH ₄ ⁺ =Over 1,000	3014093434	7683	3014068795
Combination Ammonia electrode*	5002A-10C	0.1~1,000 mg/L NH ₃	—	3014093560	membrane (NH ₃)	3014067083

*1 The selection coefficient is a ratio of the limit concentration of coexisting ions (mol/L) to the ion concentration to be measured (mol/L); A value of 1000 means that the coexisting ions can be permitted up to 1000 times the ion measured and "N/A" means that chemical change occurs in the solid response membrane.

pH Solution Kits

Name	Type	Specification	Volume	Part No.
NIST pH Buffer Solution Kit	501-S	(4.01/6.86/9.18/KCl Reference)	250mL ea	3999960015
USA pH Buffer Solution Kit	502-S	(4.01/7.00/10.01/KCl Reference)	250mL ea	3999960016

pH Solutions

Buffer Solution at 25°C	500-2	pH 1.68	500ml	3999960028
	500-4	pH 4.01	500ml	3999960029
	500-686	pH 6.86	500ml	3999960030
	500-7	pH 7.00	500ml	3999960031
	500-9	pH 9.18	500ml	3999960032
	500-10	pH 10.01	500ml	3999960033
	500-12	pH 12.46	500ml	3999960034

Conductivity Solution Kit

Name	Type	Specification	Volume	Part No.
Conductivity Standard Solution Kit	503-S	(84 uS/1413 uS/12.88 mS/111.8 mS)	250ml ea	3999960017

Conductivity Solutions

Conductivity Standard Solution at 25°C	500-21	84 uS	500ml	3999960035
	500-22	1413 uS	500ml	3999960036
	500-23	12.88 mS	500ml	3999960037
	500-24	111.8 mS	500ml	3999960038

ORP

Name	Type	Specification	Part No.
Powder for ORP Standard Solution	160-51	89 mV For 250 mL (10 packets per set)	3200043618
	160-22	258 mV For 250 mL (10 packets per set)	3200043617

Internal Filling Solution for Electrodes

Name	Type	Specification	Volume	Part No.
Internal Filling Solution for pH Combination Electrode	525-3	3.33 M KCl	250ml	3999960023
Internal Filling Solution for Reference Electrode	300	3.33 M KCl	250ml	3200043640

Accessories

		Name	Part No.
Printer		Printer (for GLP/GMP compliance)	3014030147 (230v)
		Cable sold separately, Plain paper	3014030146 (120v)
		Printer cable (1.5 m)	3014030148
		Printer paper (20 rolls)	3014030149
		Ink ribbon (5 pcs/set)	3014030150
Power		AC adapter cable set for LAQUA meters. (AC adaptor 1.8 m, cable 1 m)	3014031952 (230v) 3014031951 (120v)
For Inspection		Digital simulator X-51 (pH, mV, ION, DO simulator)	3014028368
		Digital simulator X-52 (Conductivity simulator)	3014028370
Meter Accessories		LCD protection sheet (2 pcs/pack)	3200382462
		Protection cover (Protects the meter for F-70, DS-70 series)	3200382441
Communication and Output		USB cable (Cable to connect meter and PC.)	3200373941
		Analog cable (Analog (alarm) output cable)	3014030152
		Serial cable (Cable to connect meter and PC (Serial, 9 pins))	3014030151
Electrode Stand (images on the right)		FA-70S Electrode stand (adjustable type) (Free-standing type. Height 384 mm)	3200382557
		FA-70L Electrode stand (long type) (Free-standing type. Height 450-650mm)	3200382560
		Arm for electrode stand (For FA-70S, FA-70L)	3200373991
Electrode Accessories		Sensor Holder (Used for Mounting Electrode Stand, 2 pcs.)	3200373961
		Electrode Protection Cap (Standard) (For 9615-10, 9618-10D, 9681-10D pH Electrode, 3 pcs.)	3200382477
		Electrode Protection Cap (Standard) (For 9621-10D, 9625-10D, 9630-10D, 9631-10D, 9632-10D, 6367-10D, 6377-10D, 6252-10D, 6261-10C, 1066A-10C, 1076-10C, 2060-10T, 9300-10D, 9382-10D, 3552-10D pH Electrode, 5 pcs.)	3200043508
		Electrode Protection Cap for Long Electrode (For 9678/9680 pH Electrode, 1 pc.)	3200382482

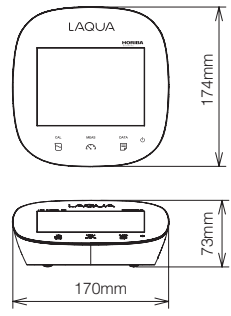

Body • Standard Electrode Stand

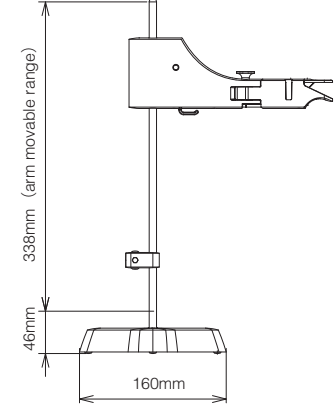

Long Type Electrode Stand

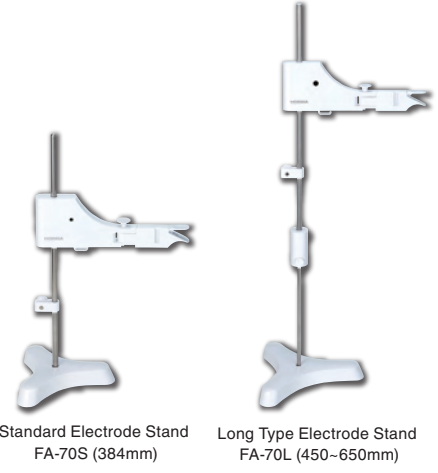
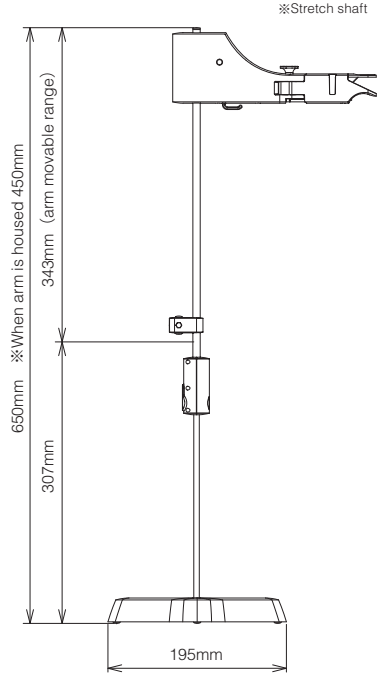

		F-71	F-72	F-73	F-74	F-74BW	DS-71	DS-72
pH	Measurement method	Glass electrode method					—	—
	Measurement range	pH 0.000~14.000					—	—
	Display range	pH -2.000~19.999	pH -2.000~20.000			pH -2.000~19.999	—	—
	Resolution	0.001 pH	0.01/0.001 pH			0.001 pH	—	—
	Auto range select	—	●	●	●	—	—	—
	Repeatability	±0.005 pH±1 digit	±0.001 pH±1 digit			±0.005 pH±1 digit	—	—
	pH calibration point	5	5			5	—	—
	Repeatability check	●	●	●	●	●	—	—
	Alarm limit of calibration	●	●	●	●	●	—	—
Periodical check	—	●	●	●	●	—	—	
mV (ORP)	Measurement range	±1999.9 mV					—	—
	Resolution	0.1 mV					—	—
	Repeatability	±0.1 mV±1 digit					—	—
Temperature	Measurement range	0.0~100.0°C (-30.0~130.0°C)					—	—
	Resolution	0.1°C					—	—
	Repeatability	±0.1°C±1 digit					—	—
ION	Measurement method	—	Ion electrode method			—	—	
	Measurement range	—	0.00 μg/L~999 g/L (mol/L)			—	—	
	Resolution	—	3 significant digits			—	—	
	Repeatability	—	±0.5%F.S.±1 digit			—	—	
	Periodical check	—	●	●	●	—	—	
	Calibration curve point	—	5	5	5	5	—	—
	Addition method measurement	—	●	●	●	—	—	
Conductivity	Measurement method	—	—	—	2 AC bipolar method			
	Measurement range (Display range)	—	—	—	0.0 μS/cm~19.99 μS/cm : Cell constant 0.1/cm 0.000 mS/cm~199.9 mS/cm : Cell constant 1.0/cm 0.00 mS/cm~1999.0 mS/cm : Cell constant 10.0/cm			
	Resolution	—	—	—	0.05% of full scale			
	Repeatability	—	—	—	±0.5%F.S.±1 digit			
	Measurement unit selection	—	—	—	●	●	●	●
	Distilled water temperature conversion	—	—	—	●	●	●	●
	Periodical check	—	—	—	●	—	—	●
JP/EP/USP/CP Pharmaceutical water application	—	—	—	●	—	—	●	
Salinity	Measurement method	—	—	—	Conversion from conductivity value			
	Measurement range (Display range)	—	—	—	0.00~80.00 ppt (0.000%~8.000%)			
	Resolution	—	—	—	0.01 ppt (0.001%)			
	Salt concentration calibration	—	—	—	●	●	●	●
Resistivity	Measurement method	—	—	—	Conversion from conductivity value			
	Measurement range (Display range)	—	—	—	0.0 Ω·cm~199.9 MΩ·cm : Cell constant - 0.1/cm 0.00 Ω·cm~19.99 MΩ·cm : Cell constant - 1.0/cm			
	Resolution	—	—	—	0.05% F.S.			
	Repeatability	—	—	—	±0.5%F.S.±1 digit			
TDS	Measurement method	—	—	—	Conversion from conductivity value (EN27888 or TDS Factor)			
	Measurement range (Display range)	—	—	—	0.01 mg/L~1000 g/L	0.01 mg/L~100 g/L	0.01 mg/L~1000 g/L	
	Resolution	—	—	—	0.01 mg/L			
Input/output	Input (number of channels)	1	1	2	2	2	1	1
	USB peripherals (Communication with PC)*1	●	●	●	●	●	●	●
	USB host (USB memory)	—	●	●	●	—	—	●
	RS-232C (Printer/PC)	●	●	●	●	●	●	●
Data	Analog output	—	●	●	●	—	—	●
	Memory number	999	2000	2000	2000	999	999	2000
	Interval memory	●	●	●	●	●	●	●
	ID input	●	●	●	●	●	●	●
Data search	—	●	●	●	●	—	—	●
Display	Display	Custom LCD	Color graphic LCD with capacitive Touch Panel			Custom LCD		Color graphic LCD with capacitive Touch Panel
	Dual component display	—	—	●	●	●	—	—
	Multilanguage display	—	Japanese/English/Chinese/Korean			—	—	Japanese/English/Chinese/Korean
Function	Navigation function	—	●	●	●	—	—	●
	User guide	—	●	●	●	—	—	●
	Graph display	—	●	●	●	—	—	●
	Printer connectivity (GLP/GMP)	●	●	●	●	●	●	●
	Custom printing function	—	●	●	●	—	—	●
	Temperature compensation (Auto/manual)	●	●	●	●	●	●	●
	AutoHold function	●	●	●	●	●	●	●
	AutoHold setting	—	●	●	●	—	—	●
	Stability function (pH/ION)	—	●	●	●	—	—	●
	Operator ID	—	●	●	●	—	—	●
Security (password)	●	●	●	●	●	●	●	
Version up function	●	●	●	●	●	●	●	
Ambient temperature	0~45°C							
Power	AC adaptor 100 ~ 240 V 50/60 Hz							
Dimensions	170 (W)×174 (D)×73 (H)mm (Excluding electrode stand and AC adaptor)							
Power consumption	Approx. 0.7 VA	Approx. 9.8 VA			Approx. 0.7 VA		Approx. 9.8 VA	
Mass of main unit	Approx. 500 g	Approx. 700 g			Approx. 500 g		Approx. 700 g	

*1 USB cable sold separately. Software can be download by web registration.

With over 60 years of engineering excellence, HORIBA's diverse range of water quality analyzers and electrodes are ideal for everyday laboratory needs through to the most demanding of applications. Visit our website for a wealth of useful information and water quality measurement tips to help you obtain the best results in your work.



Benchtop Meters

Developed using extensive feedback from users, our new LAQUA meters deliver the best solution for water quality analysis. Our LAQUA website features an online 'Selection Guide' to enable you to find the perfect LAQUA meter and electrode for your need.

Handheld Meters

In the lab, in the field or anywhere you need it. LAQUA Handheld meters are designed for use with one hand and with an IP67 waterproof rating and shock-resistant casing. Meters can be used for long periods, even in dark places, making it ideal for field measurements in rivers and lakes.

Pocket Meters

Analyzing water quality is simplified when using our LAQUAtwin range of meters. Designed to produce accurate and reliable results. Anyone, anywhere, at any time can measure samples easily with a LAQUAtwin meter. See just how good they are at our website.

Electrodes

Various electrodes to match any application. A wide range of products for both benchtop and portable systems are available, including easy and reliable standard models, application-focused models for small samples or large containers, and special electrodes for specific sample characteristics.

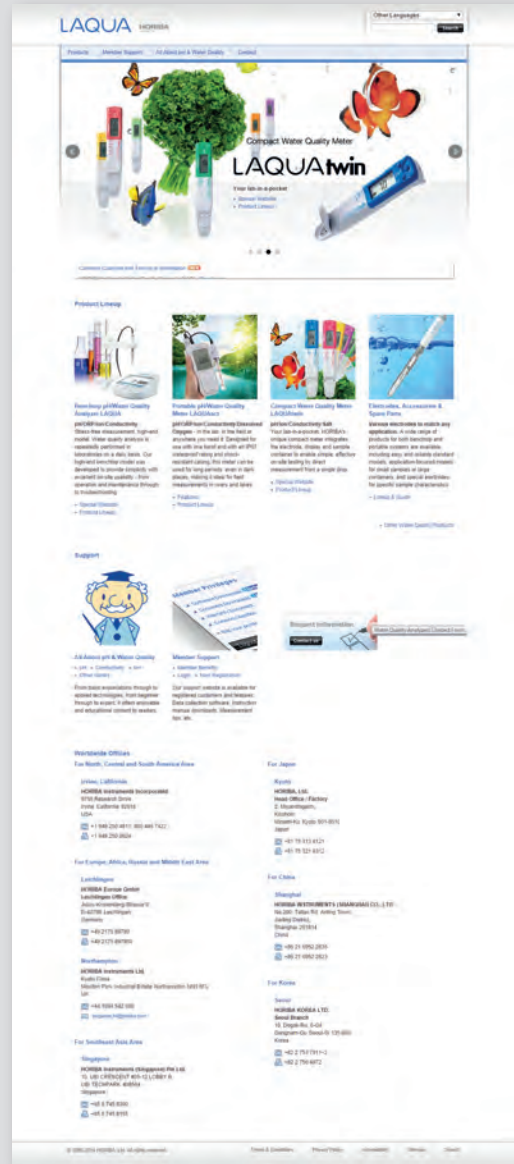

SUPPORT HORIBA CUSTOMER SUPPORT SYSTEM

HORIBA offers a variety of services to conform to quality standards and international guidelines such as GLP, GMP and ISO

<p>Technical Support</p> <p>Please contact us with any technical questions about our products.</p> <p>www.horiba.com/wq/support</p>	<p>User Support</p> <p>Our support website is available for registered customers and features:</p> <ul style="list-style-type: none"> •Data collection software •Instruction manual downloads •Measurement tips, etc. <p>www.horiba.co.jp/register</p>	<p>Validation Support</p> <p>Please contact us with any questions or requirements for your validation procedure.</p> <ul style="list-style-type: none"> •Traceability certification* •IQ/OQ/PQ support* •SOP guidance •FAQ <p>*Optional services</p>
---	---	---

Please read the operation manual before using this product to assure safe and proper handling of the product.

- The contents of this catalog are subject to change without prior notice, and without any subsequent liability to this company.
- The color of the actual products may differ from the color pictured in this catalog due to printing limitations.
- It is strictly forbidden to copy the content of this catalog in part or in full.
- All brand names, product names and service names in this catalog are trademarks or registered trademarks of their respective companies.
- Windows is a registered trademark of Microsoft Corporation in the United States and other countries.

<http://www.horiba.com> e-mail: enquiry@horiba.com.sg

HORIBA Instruments (Singapore) Pte. Ltd.

83 Science Park Drive
 #02-02A, The Curie
 Singapore 118258
 Phone: 65 (6) 908-9660
 Fax: 65 (6) 745-8155

