

# **TES** pH / ORP / Temperature Meter

## **TES-1380**

### **INSTRUCTION MANUAL**

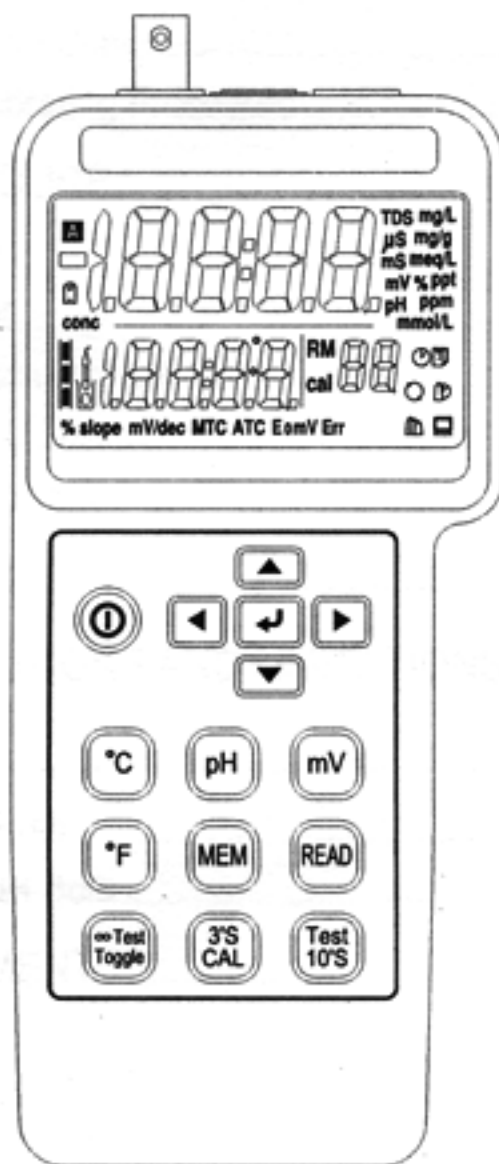



**TES ELECTRICAL ELECTRONIC CORP.**

# TABLE OF CONTENTS

Title	Page
1. SPECIFICATIONS .....	1
1-1 General Information .....	1
1-2 Electrical Specifications .....	2
2. FRONT PANEL DESCRIPTION .....	3
3. pH TEMPERATURE COMPENSATION.....	5
4. CALIBRATING PROCEDURE.....	5
4-1 pH Calibrating Procedure.....	5
4-2 Temperature Calibrating Procedure .....	7
5. MEASURING PROCEDURE .....	7
5-1 pH Measurement.....	7
5-2 mV Measurement.....	7
5-3 Temperature Measurement .....	7
5-4 Auto Data Hold .....	8
5-5 Data Record (Record & Read & Clear).....	8
6. SETTING PROCEDURE .....	8
7. ELECTRODE PRECAUTIONS AND LIMITATIONS .....	10
8. MAINTENANCE.....	11
8-1 Cleaning the pH Bulb .....	11
8-2 Recondition the pH Bulb .....	11
9. BATTERY REPLACEMENT .....	11
10. DATALOGGING.....	12
10-1 Software .....	12
10-2 Parameter Settings .....	17
10-3 Download datalogger (pH Meter → PC).....	18
10-4 Data Invert.....	21
10-5 Communicating Operation .....	26

## 1. SPECIFICATIONS

### 1-1 General Information

Circuit :	Custom one-chip of microprocessor circuit.
Display :	76.5mm×50.5mm×2.7mm super large LCD dual display.
Measurement :	pH : 0 to 14 pH mV : 0 to 1999mV Temperature : 0°C to 100°C ( 32°F to 200°F)
Temperature compensation for pH range :	Manual(MTC): 0°C to 100°C(32°F to200°F), adjusting by push  button or  button on front panel. Automatic(ATC): 0°C to 100°C(32°F to 200°F),adjusting with the optional temperature probe.
Calibration for pH range :	Built in (pH4.010 and pH7.000) calibration  on front panel, high reliability.
Auto data hold :	The <b>A</b> indicator will halt in LCD from flash status when the electrode output becomes stable.
Memory recall :	Single recording: 99 records. Continuous recording: Have 99 sets of records, MAX. 3000 points.
Auto power off :	10 minutes.
Over input indication :	Indicate by " ---- "
pH electrode :	Any kind of Ph electrode can be connected with BNC connector.
Operating temperature :	0°C to 50°C ( 32°F to 122°F).
Operating humidity :	Max 80% RH.
Sampling rate :	About 1.5 time per second.
Battery life :	Approx. 120 hours.
Calibration date :	Record the last data of adjustment.

Power supply : UM-1.5V x 6  
 Power current : Approx. DC 20mA.  
 Data output : RS232 PC serial interface.  
 Dimensions : 187(L) x 73(W) x 53(H)  
 Weight : Approx. 320g with batteries.  
 Application range : Stains 、 Lotion 、 Chemical 、 Brew 、  
 Bacteriology 、 Filthy water 、 Pulp 、 Pharmacy 、  
 Ferment 、 Electroplate 、 Drink 、 Aquaculture etc.  
 Accessories : Carrying case, Instruction manual, Software,  
 Batteries, RS-232 Cable, 9pin to 25pin Gender  
 changer.  
 Option Accessories : pH 4 buffer solution, pH 7 buffer solution,  
 pH electrode, Temperature probe.

## 1-2 Electrical Specifications





( 23 ± 5°C )

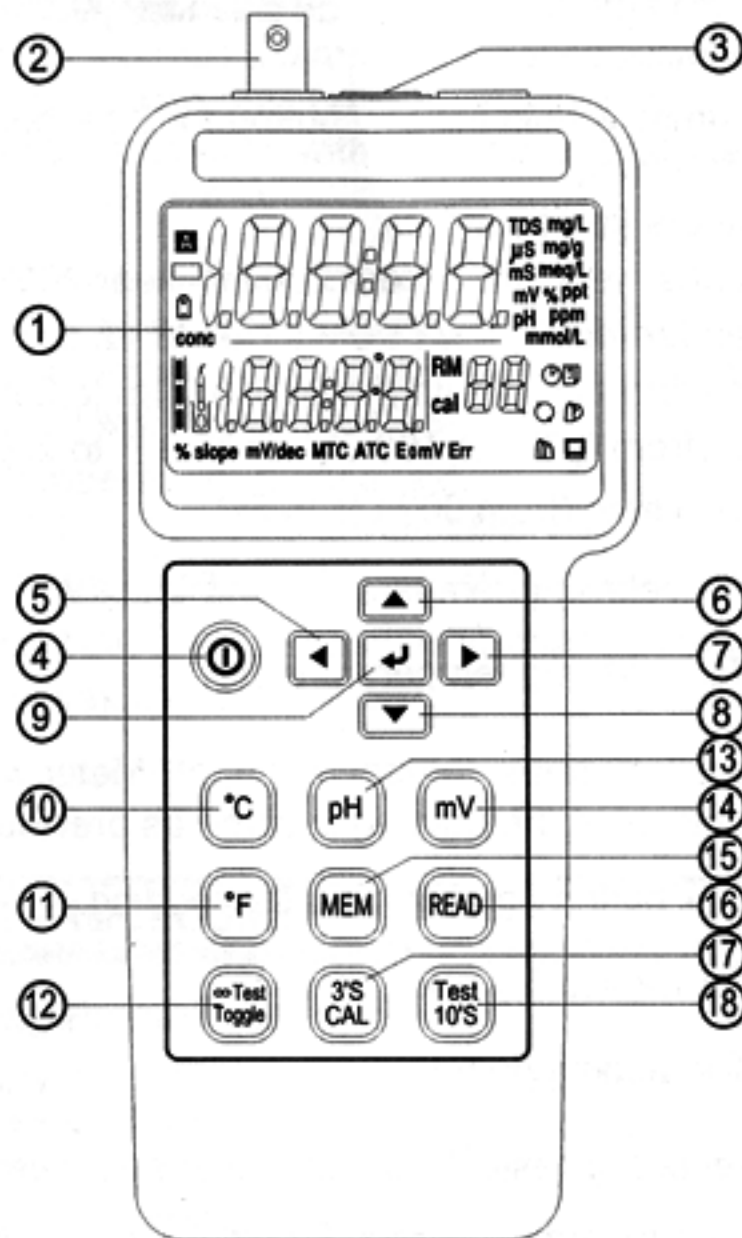



















Measurement	Range	Resolution	Accuracy
pH	0 to 14pH	0.001pH	± 0.01pH
mV	0 to 600mV 601mV to 1999mV	0.1mV	± (0.05%+1d) ± 0.1%
Temp (°C)	0 to 100°C	0.1°C	± 0.5°C
Temp (°F)	32 to 200°F	0.1°F	± 0.9°F

## 2. FRONT PANEL DESCRIPTION



(Fig-1)



- 1). LCD : Measured values, unit, symbols, and decimal points are displayed.
- 2). Input socket : BNC connector for pH and mV.
- 3). Input socket : Earphone jack for temperature probe.
- 4).  : Button for power on/off.
- 5).  : Button for moving to the desired parameters.
- 6).  : Button for increasing the value of parameters.
- 7).  : Button for moving to the desired parameters.
- 8).  : Button for decreasing the values of parameters.

- 9).  : Button for entering/escaping the mode of parameter settings.  
 Don't release the key to increase the value rapidly.  
 Press  button, it will display calendar year and month, day, hour, minute, second.  
 If user press & hold the  button for 2 seconds, it will perform as the following:  
 Parameters (in sequence):  
 Calendar year (from Year 2000 to Year 2099)  
 Calendar month-day ( from 01-01 to 12-31)  
 Calendar hour-minute ( from 00h:00m to 23h:59m)  
 MTC (from 0.0°C to 100.0°C or 32.0°F to 200.0°F)  
 Interval time (from 002s to 255s)
- 10).  : Button for selecting temperature unit °C.
- 11).  : Button for selecting temperature unit °F.
- 12).  : In continuous measurement mode, pH Meter will not stop measuring even the reading is same as previous reading.  
 Press  button again to hold the reading.
- 13).  : Button for measuring pH.
- 14).  : Button for measuring mV.
- 15).  : Single record : Press  button to get and memorise the reading.  
 Continuous recording : Press & hold  button for 2 secs, it will start continuous recording. (M1~M99 sets, MAX 3000 points/1 set).  
 Memory Clearing: Press & hold  button and to re-power on the meter, LCD will appear " Clr " indicator, it means that the memories have been cleared.
- 16).  : To read the memorized value for pH 、 mV 、 temperature (R1~R99 sets).
- 17).  : Press & hold  button for 3 secs to enter into the adjustment mode, select the reference calibrated value of pH or temperature by pressing   , then press  button to complete the adjustment.
- 18).  : Press  button, the **A** indicator will flash and halt in LCD (around 10 secs), the reading is also held , the meter stops measuring at this moment.

### 3. pH TEMPERATURE COMPENSATION

Enable the meter to read solutions at various temperatures, the meter will make the correct electrode's temperature dependency to measure the pH value. The compensation may be manual with a button adjustment on the meter, or it may be automatic with an optional temperature sensing probe immersed in the test solution.

➤ Temperature compensation mode :

- 1). Automatic temperature compensation: To connect the optional temperature probe with earphone jack and immerse in the test solution, LCD will appear "ATC" sign.
- 2). Manual temperature compensation: You can enter temperature between 0.0°C to 100.0°C manually. (An ATC probe will override manual compensation.) The preset temperature of pH Meter 0 is 25 °C. Use  button or  button to change temperature. Press  to enter the value and move on.

### 4. CALIBRATING PROCEDURE

#### 4-1 pH Calibrating Procedure

It is necessary to make the following calibration procedures, if user intends to keep the instrument and the electrode at high accuracy or it is the first time for user to use the meter and the electrode.

If the inaccuracy of the electrode is too large, LCD will display "Err".

- 1). Connect the combination pH electrode to the BNC socket and place the electrode into the buffer solution (pH 7.00).



(Fig-2)

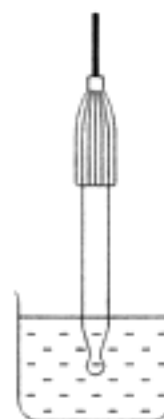

(Fig-3)



- 2). Select ATC mode or MTC mode.

3). Waiting for the reading to be stable.

4). Press and hold  button for 3 seconds to enter into the calibration mode.



(Fig-4)

5). Select pH mode (The preset value is pH 7.000 or user can press  or  to select).



(Fig-5)



(Fig-6)

6). Press  button to complete offset calibration.



(Fig-7)

7). Rinse electrode and blot with lint-free tissue.



(Fig-8)

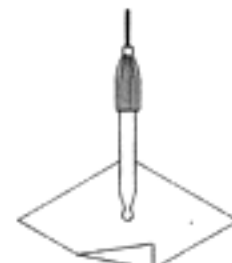

(Fig-9)

8). Slope calibration (pH 4.010), repeat steps 2 to 7.





(Fig-10)

9). Press  button for 3 seconds, LCD will display the date of last adjustment.



## 4-2 Temperature Calibrating Procedure

- 1). Plug in the "optional temperature probe" into the earphone jack. Place the temperature probe into the 0°C ice solution.
- 2). Press  button is hold 3 seconds.
- 3). Select °C mode.
- 4). Press  button then complete calibration.

## 5. MEASURING PROCEDURE

### 5-1 pH Measurement

Calibrate the instruments and pH electrode before measuring.



- 1). Connect the combination pH electrode to the BNC socket.
- 2). Power on the instrument by pushing the power on/off button.
- 3). If the operation is under the "ATC", then please refer to 3-1 measuring procedures.
- 4). If the operation is under the "MTC", then please refer to 3-2 measuring procedures.
- 5). Place the electrode into the measured solution, the instrument will display the pH value.
- 6). After making the measurement, please rinse the electrode with distilled water.

### 5-2 mV Measurement

The instrument builds in mV measuring function letting you make ORP or other precised mV measurements.

Select the mV function, the meter will show the mV values on the display.

### 5-3 Temperature Measurement

- 1). Plug in the "optional temperature probe" into the earphone jack.
- 2). Press  or  button to select temperature units.
- 3). Place the temperature probe into the tested solution, then the meter will show the temperature value and ATC sign.  
If take the temperature probe out, then the meter will show the MTC sign.

## 5-4 Auto Data Hold



Press and hold  button during measurement. When the reading is stable, **A** indicator will flash and then halt on LCD.

If you want to cancel the data hold status, press  button again to revert to the measuring status and **A** will disappear.

Press  button again to hold the reading.



## 5-5 Data Record (Record & Read & Clear)

### 1). Memorize the readings

pH Meter can memorize the readings up to 99 records. Press  button to record data represented by M(1~99). If press  button and hold around 2 seconds, it will enter into continuous recording status. (M1~M99 sets, MAX 3000 points).

### 2). Recalling memory

Press READ button, LCD will show the last record.

Press  or  button to review the data you recorded.

R1 to R99 indicates the order of readings you measured.

### 3). Memories Clearance

Press and hold  button to re-power on the meter. It will enter into the measuring mode until LCD shows "Clr" symbol.

## 6. SETTING PROCEDURE



Pls. follow the following steps to set up the parameters for ① Calendar Year, ② Monty-Day & Time (Hour:Minute), ③ Manual temperature compensation, ④ Interval time of record.

1). Press  around 2 secs until hearing second beeping and the digit is flicking in LCD, then you are entering into the setting mode.

2). To set up for Year by pressing.



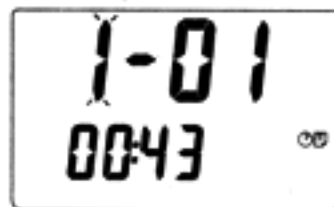

3). Press  to set up for next parameter.

4). To set up for Month by pressing  or  button.



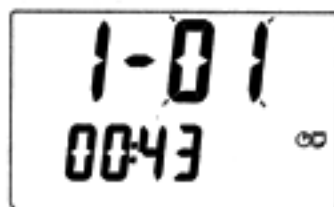

5). Press  to set up for next parameter.

6). To set up for Date by pressing  or  button.



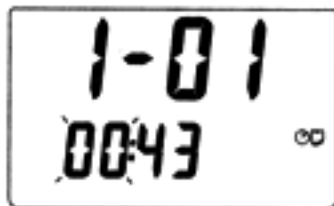

7). Press  to set up for next parameter.

8). To set up for Hour by pressing  or  button.



9). Press  to set up for next parameter.

10). To set up for Minute by pressing  or  button.

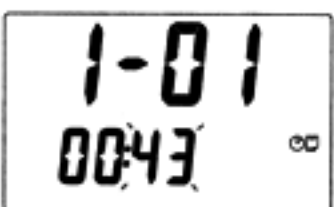

11). Press  to set up for next parameter.

12). To set up for Manual temperature compensation by pressing  or  button.



13). Press  to set up for next parameter.



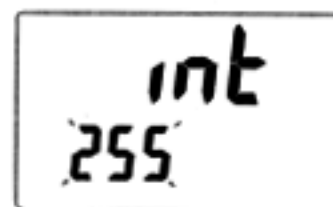

14). To set up for Interval time of record by pressing  or  button.



15). Press enter to finish the settings and return to measuring mode.

## 7. ELECTRODE PRECAUTIONS AND LIMITATIONS

- 1). Do not allow the electrode to go dry.
- 2). Do not wipe the electrode tip. Blot it with a lint-free tissue.
- 3). Do not leave the electrode in organic solvents, strongly basic solutions, concentrated fluoride solutions or hydrofluoric acid for extended periods. If measurements are made in these solutions, readings should be taken quickly and the electrode should be rinsed immediately with deionized water. After rinsing the electrode, soak it in 7.0 buffer for two hours before using again.
- 4). Do not use the electrodes in solutions that exceed a temperature range of 0°C to 100°C.
- 5). pH only

	98.0 – 102.0%
	Electrode is in good condition.
	95.0 – 97.9%
	Electrode needs to be cleaned.
	92.0 – 94.9%
	Electrode needs to be cleaned.
	Electrode needs to be renewed.

## 8. MAINTENANCE

The proper way of using and protecting the electrode, it will prolong the life of the glass membrane. If your pH electrode is exhibiting by slow response, low slope values, continuous drift, or erratic readings, follow the procedures listed below.

### 8-1 Cleaning the pH Bulb

- 1). Protein contamination: Soak the electrode bulb/tip in a 10% solution of pepsin for 30 minutes. Rinse with deionized water and soak the electrode in 7.0 buffer for two hours before using.
- 2). Oil contamination: Wash the electrode with a 50% water-acetone solution. Do not soak the electrode in the acetone solution, or it will deteriorate the bottom seals of the plastic electrode. Rinse with deionized water and soak the electrode in 7.0 buffer for two hours before using.

### 8-2 Recondition the pH Bulb

Only resort to this procedure if the preceding maintenance and cleaning procedures fail to restore acceptable electrode performance. Rinse immediately with deionized water and soak in 7.0 buffer for two hours before using.

**CAUTION:** To prevent permanent damage, care should be taken to prevent liquid permeating the pH Meter. Meanwhile, the batteries should be taken out if user will not use the meter for a long period. Also, to choose the fitted pH electrode is required.

## 9. BATTERY REPLACEMENT

- 1). When the LCD show "  ", it indicates that the normal battery output is less than 6.8V. It is time to replace the battery.
- 2). Remove the battery cover.
- 3). Replace with 9V battery (heavy duty type) and place back the cover.
- 4). Make sure the battery cover is secured after replacing the battery.

## 10. DATALOGGING

### 10-1 Software :

#### 1). PC Hardware requirements :

- HDD 1.44MB disk, 486 PC or above, with COM1, COM2 commports.
- EGA or higher monitor.
- 4M bytes or more memory size.

#### 2). PC Hardware setup :

- ① Switch off all power related to your PC.
- ② Connect the socket (female) of RS-232 cable to PC's COM1 or COM2 commport.

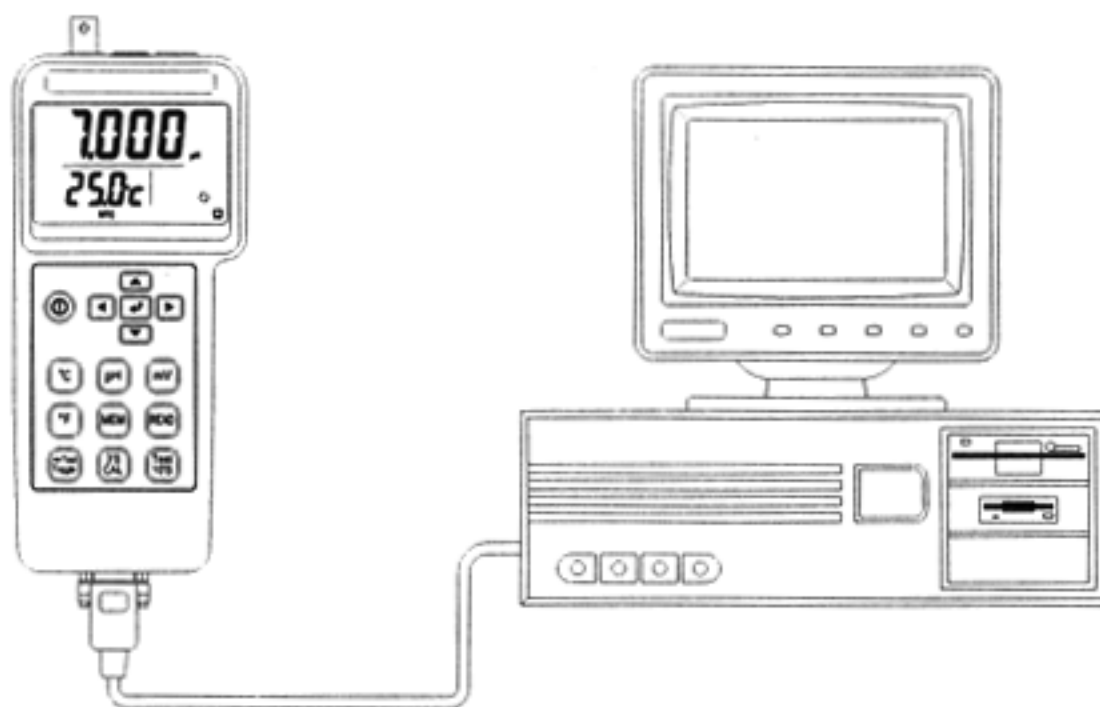

- ③ Switch on all power.
- ④ Connect the socket (male) of RS-232 cable to pH Meter.

#### 3). Software Installation :

- ① Before installing the software of pH Meter, start up windows 95/98 operating system.
- ② Close all application.
- ③ Insert the pH Meter disk1 into drive A or drive B.

- ④ Click " Start " menu and move mouse pointer to " Run ", then click this button.

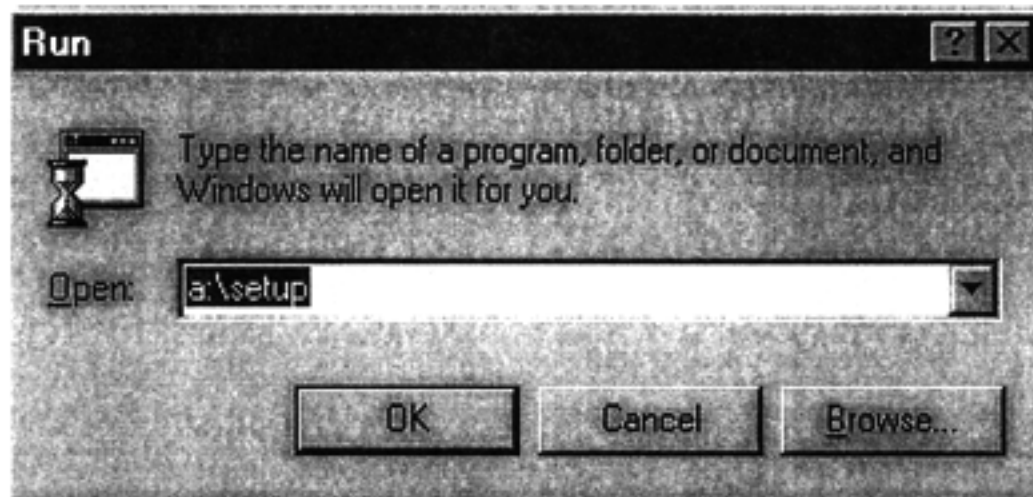
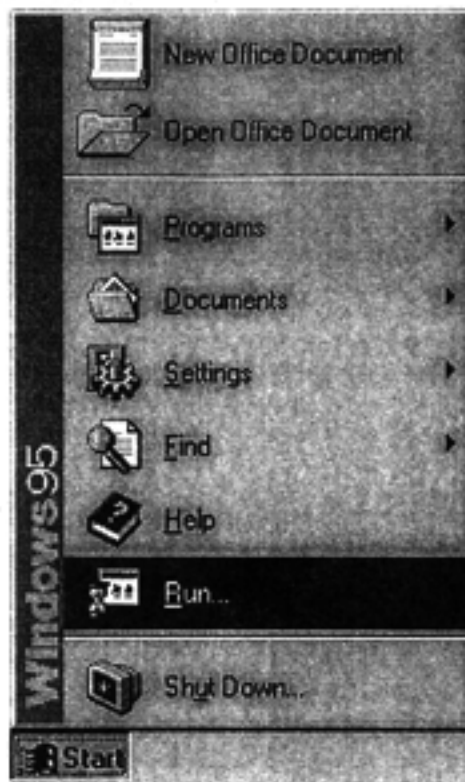

- ⑤ A " Run " window appears then user need to key in "A:\SETUP" or "B:\SETUP" and click "OK".
- ⑥ Setup program will run automatically.

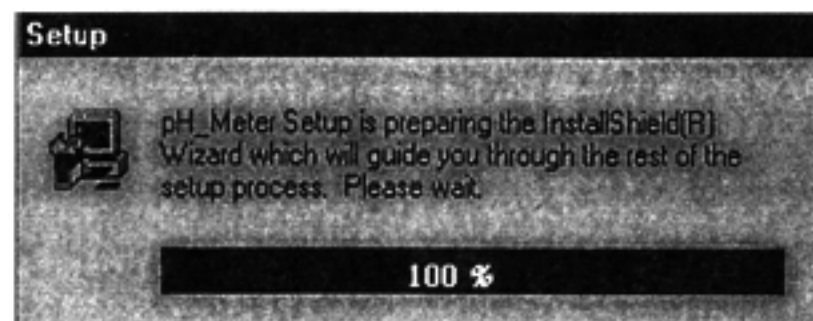



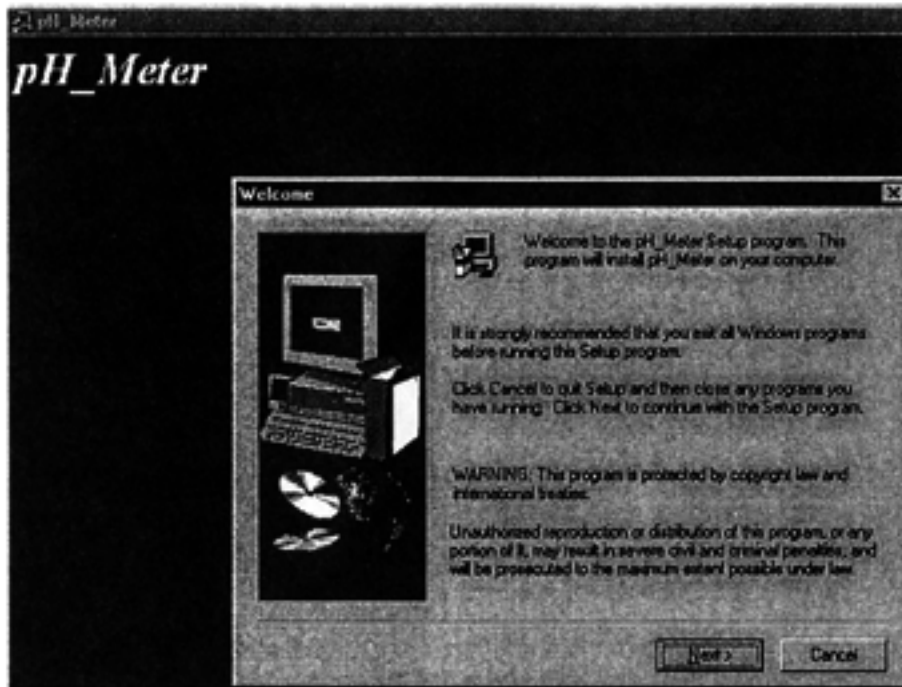

⑦ Click "NEXT"

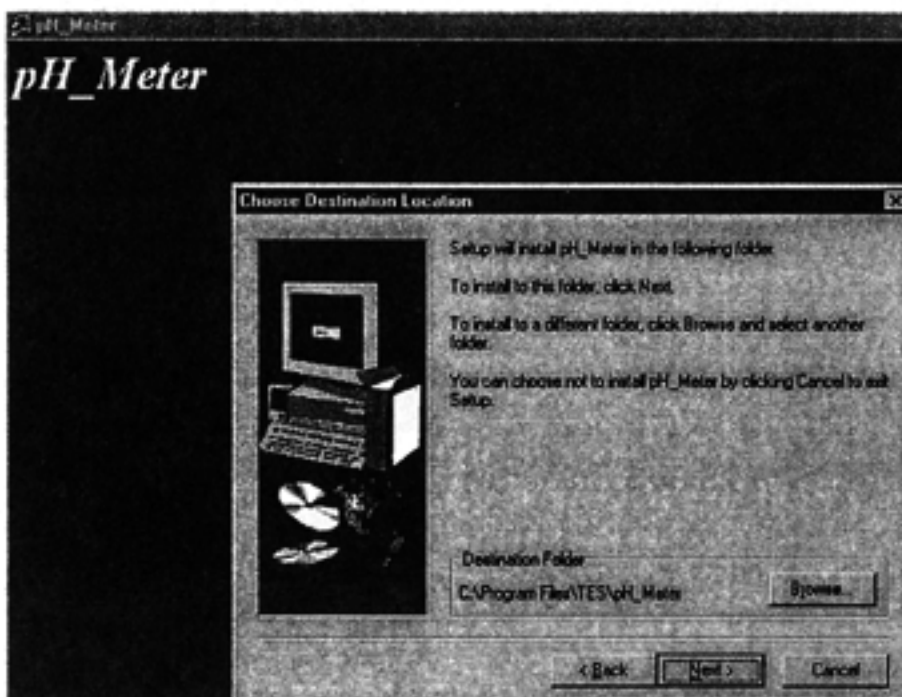

- ⑧
- a). Click "NEXT"
  - or
  - b). If user is willing to set up on a different folder, click "Browse".





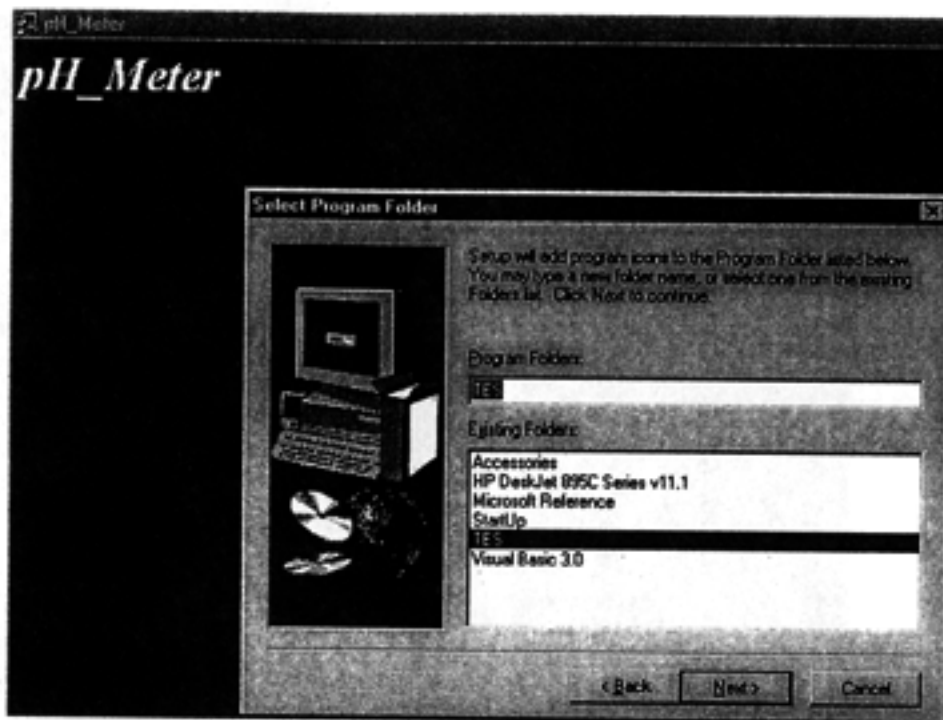

© Click "NEXT"

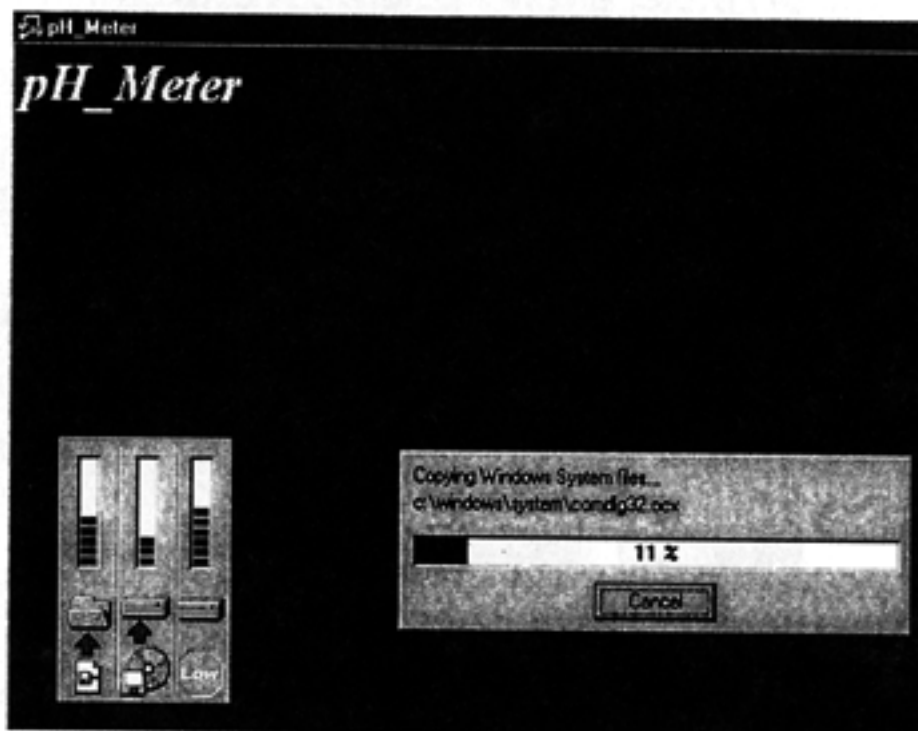

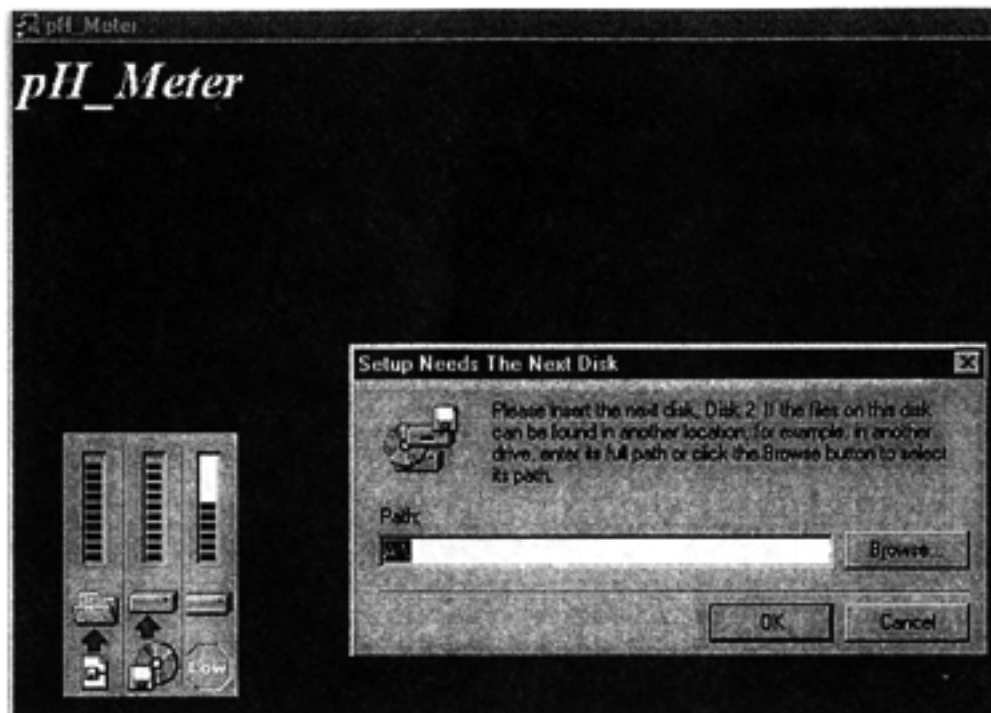

⑩ Insert the pH Meter Disk2 into drive A or B, and then click "OK"

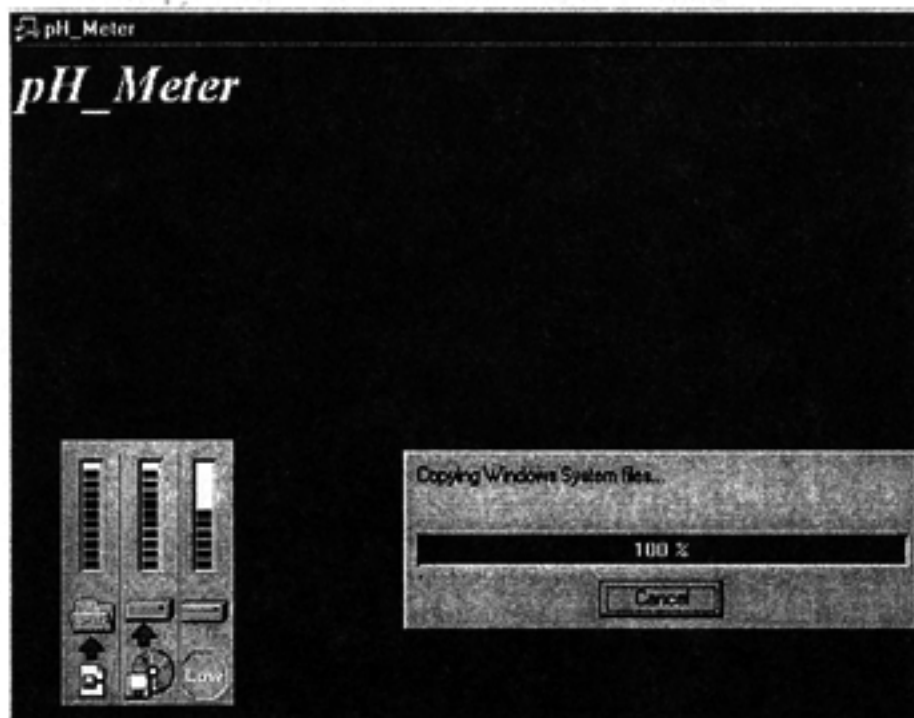

## 10-2 Parameter Settings

### 1). Start up program:

#### ① Run the pH Meter software

Click " Start " from Start menu, move mouse pointer to " Programs ", then move pointer to " Tes " (default), move mouse pointer to "pH Meter " then click.

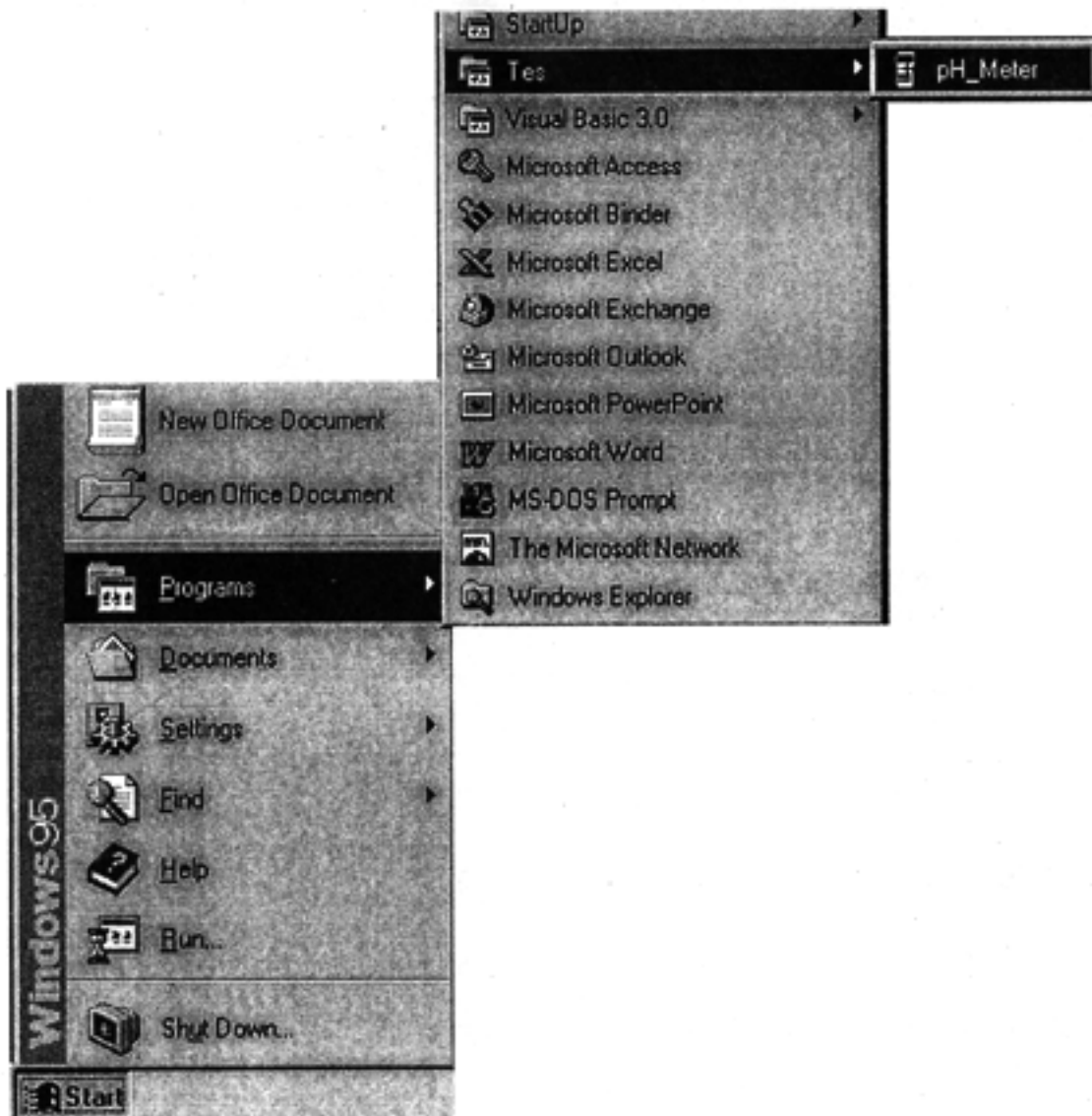

#### ② Move mouse pointer to available commport (COM1 , COM2) then click.

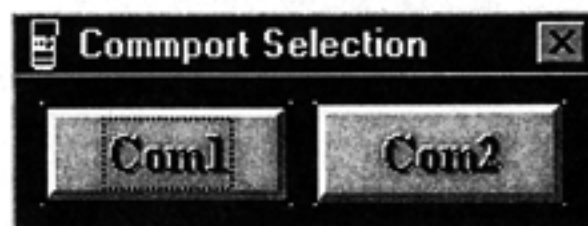

### 2). RS-232 Settings :

① Baud rate : 9600

② Parity : None

③ Data bits : 8

④ Stop bit : 1

3). Time Settings : Move mouse pointer to **Time Set** and click it to input the time of PC to the pH Meter.

4). Inner sampling time of pH Meter :

- ① Move mouse pointer to **Single Recd** then click it.
- ② In the "Memory" window, drag mouse to highlight the values of "Sampling".

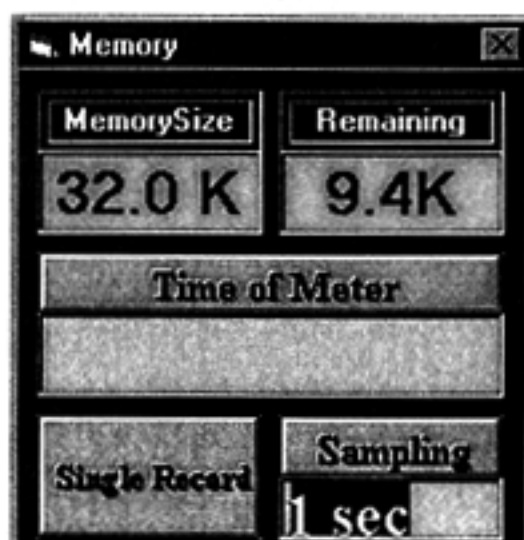

- ③ Input the sampling time that you intend to set up, then click "Sampling" button to complete it.

### 10-3 Download datalogger (pH Meter → PC)

To read recorded data in memory (EEPROM).

1). Single Record

- ① Move mouse pointer to **Single Recd** and click it.  
A "Memory" window appears.



As above, the total memory size is 32K, 9.4K is remained. The inner time of pH Meter is 00/05/11-10:45:08.

- ② In the "Memory" window, move mouse pointer to **Single Record** (at the left bottom corner of "Memory" window) then click to read.

	Date	Time	Values	Unit	Temp	C/F	A/M	Bt
1	00/05/08	08:38:01	9.708	pH	25.0	°C	MTC	
2	00/05/08	08:38:23	7.096	pH	25.0	°C	MTC	
3	00/05/08	08:38:28	8.741	pH	25.0	°C	MTC	
4	00/05/08	08:38:32	10.396	pH	25.0	°C	MTC	
5	00/05/08	11:53:20	5.648	pH	25.0	°C	MTC	
6	00/05/08	12:00:08	6.820	pH	25.9	°C	ATC	
7	00/05/08	12:06:47	6.824	pH	28.9	°C	ATC	
8	00/05/08	12:09:47	6.800	pH	26.6	°C	ATC	

## 2). MultiRecords

- ① Move mouse pointer to **Multi Rec** and click it. A "Memory" window appears.

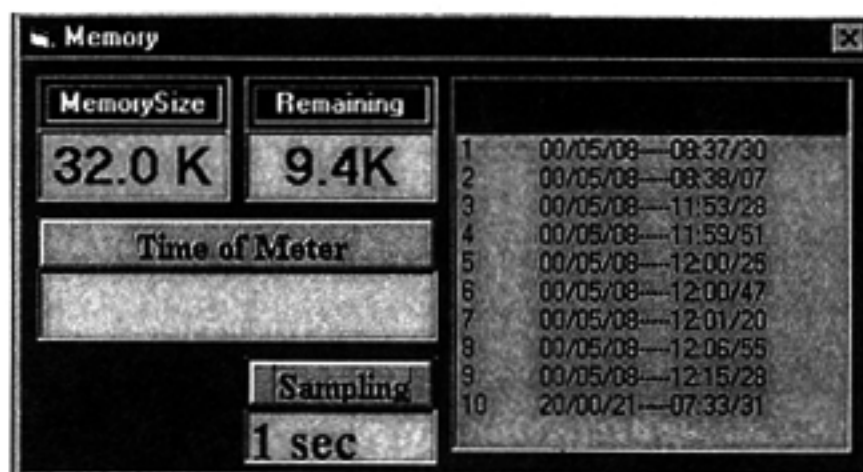
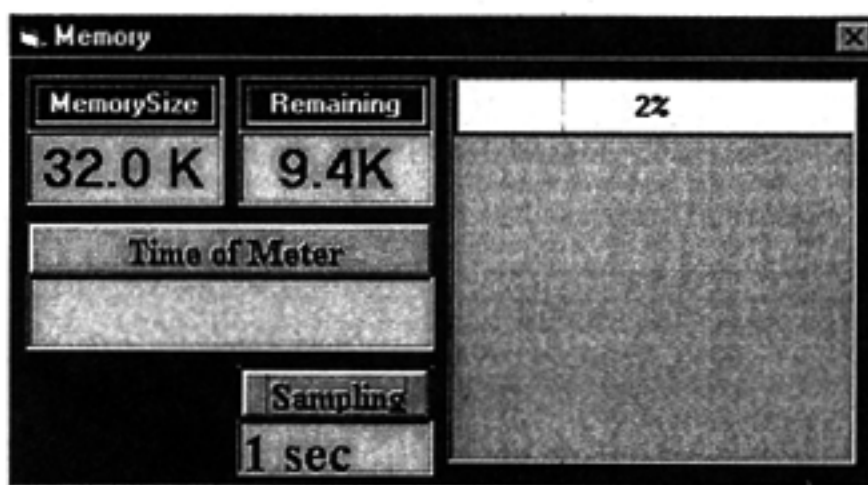

The blue bar will display downloaded percentage. Please wait while downloading.

As above, the total memory size is 32K, 9.4K is remained.

The inner time of pH Meter is 00/05/11-10:45:08.

② Move mouse pointer to the listed record and then click if willing to read.

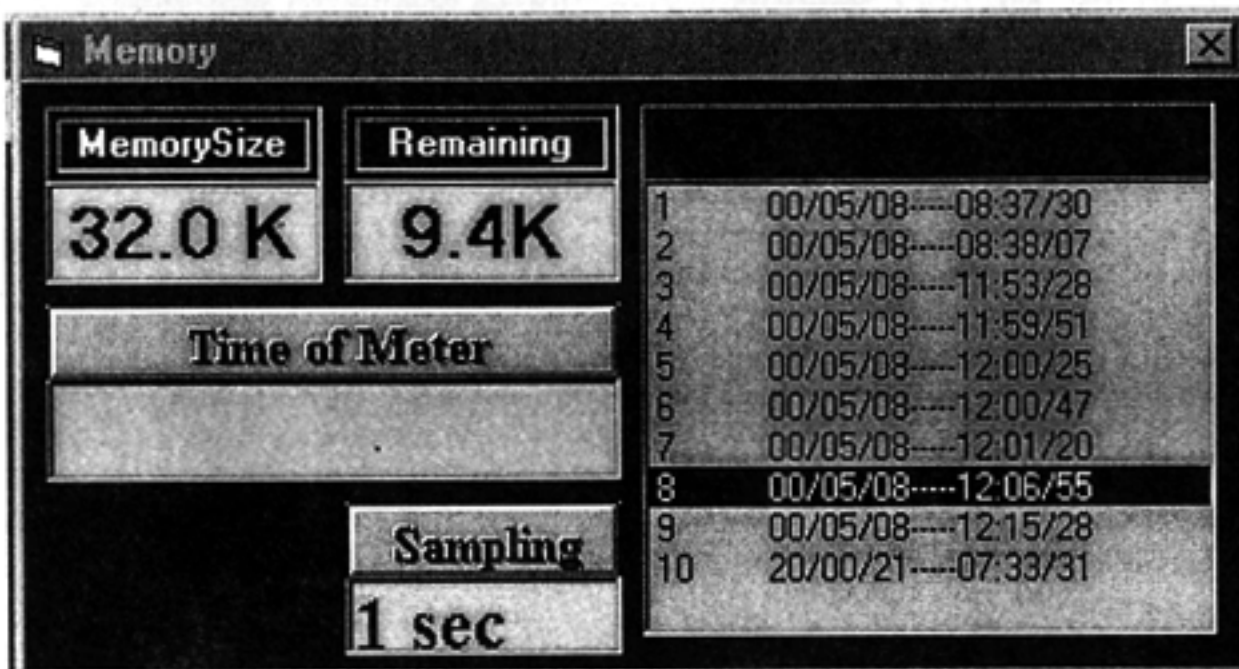

The 'DataList' window shows 171 records completed. The table below displays the first 20 records:

	Date	Time	Values	Unit	Temp	C/F	A/M	Bl
1	00/05/08	12:06:55	6.896	pH	25.0	°C	MTC	
2	00/05/08	12:06:56	6.896	pH	28.6	°C	ATC	
3	00/05/08	12:06:57	6.874	pH	28.6	°C	ATC	
4	00/05/08	12:06:58	7.022	pH	28.6	°C	ATC	
5	00/05/08	12:06:59	7.022	pH	28.5	°C	ATC	
6	00/05/08	12:07:00	6.998	pH	28.5	°C	ATC	
7	00/05/08	12:07:01	6.846	pH	28.5	°C	ATC	
8	00/05/08	12:07:02	6.846	pH	28.5	°C	ATC	
9	00/05/08	12:07:03	6.823	pH	28.5	°C	ATC	
10	00/05/08	12:07:04	6.808	pH	28.5	°C	ATC	
11	00/05/08	12:07:05	6.808	pH	28.4	°C	ATC	
12	00/05/08	12:07:06	6.792	pH	28.4	°C	ATC	
13	00/05/08	12:07:07	6.792	pH	28.4	°C	ATC	
14	00/05/08	12:07:08	6.804	pH	28.3	°C	ATC	
15	00/05/08	12:07:09	6.815	pH	28.3	°C	ATC	
16	00/05/08	12:07:10	6.815	pH	28.3	°C	ATC	
17	00/05/08	12:07:11	6.825	pH	28.3	°C	ATC	
18	00/05/08	12:07:12	6.833	pH	28.2	°C	ATC	
19	00/05/08	12:07:13	6.833	pH	28.2	°C	ATC	
20	00/05/08	12:07:14	6.839	pH	28.2	°C	ATC	

**SAVE** : To save recorded data in HDD applying for other applications such as EXCEL, WORD. For example, P.23.

a). Move mouse pointer to "SAVE" then click this button.



- b). A dialog box will come up. Input the name of the file if willing to save as.
- c). Click " Save ".

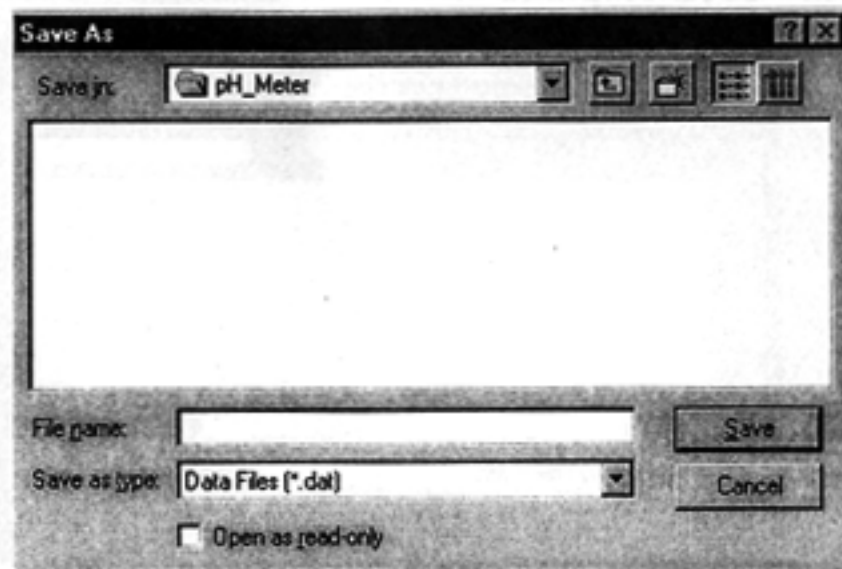

#### 10-4 Data Invert

1). Save data by RS-232 communication port in PC.

- ① Run pH Meter software, check if pH Meter connected with PC well. If not connected, the " NO COM " signal will display, please be sure RS-232 cable line is connected with COM1 or COM2. After connection, the reading will be shown, and COM1 or COM2 also will be shown in the screen.



- ② Move mouse pointer to **Save As** and click this button, you can find the " Save As " dialog box, please change to new file name: \*.xls from original file \*.dat then press enter. For example : test.xls

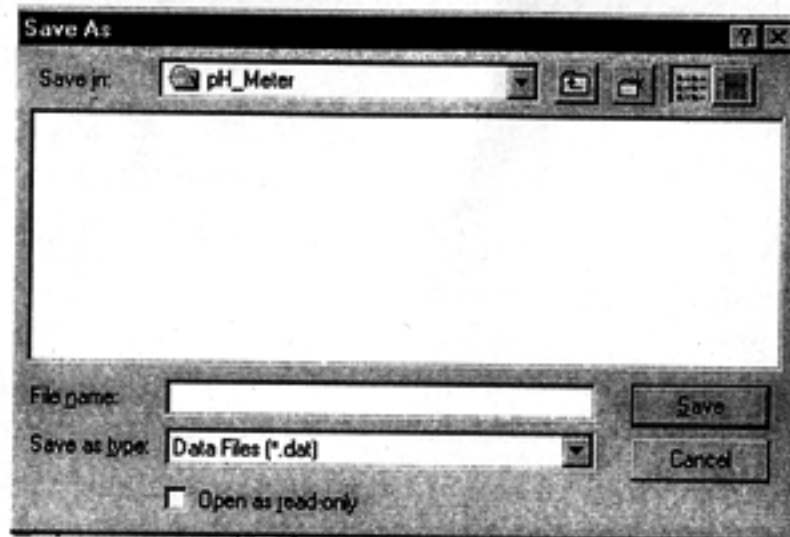

- In the " File Name " column, the file name you key-in will be shown.
- ③ In the "Recording" column, No. of PC record will be displayed from 1 up to end.
- ④ If user intend to end this record, please move mouse pointer to **Stop Rec** and click it. The " Recording " signal will disappear.



2). Apply for Excel :

① Open Microsoft EXCEL, go to "open file ", from the searching function.

a). Find the EXCEL type. For example, test.xls. Select test.xls then click "open" button.

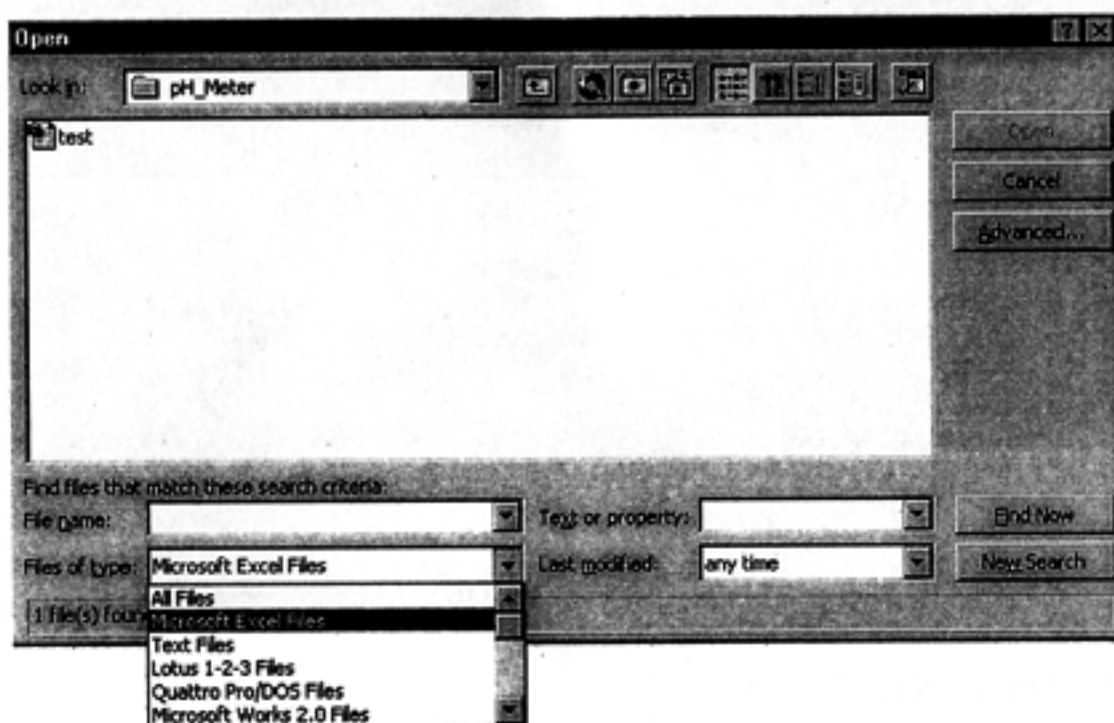

b). From the " Files of type ", click the pull down pointer, then choose "All Files ", select sample.dat then click "open" button.

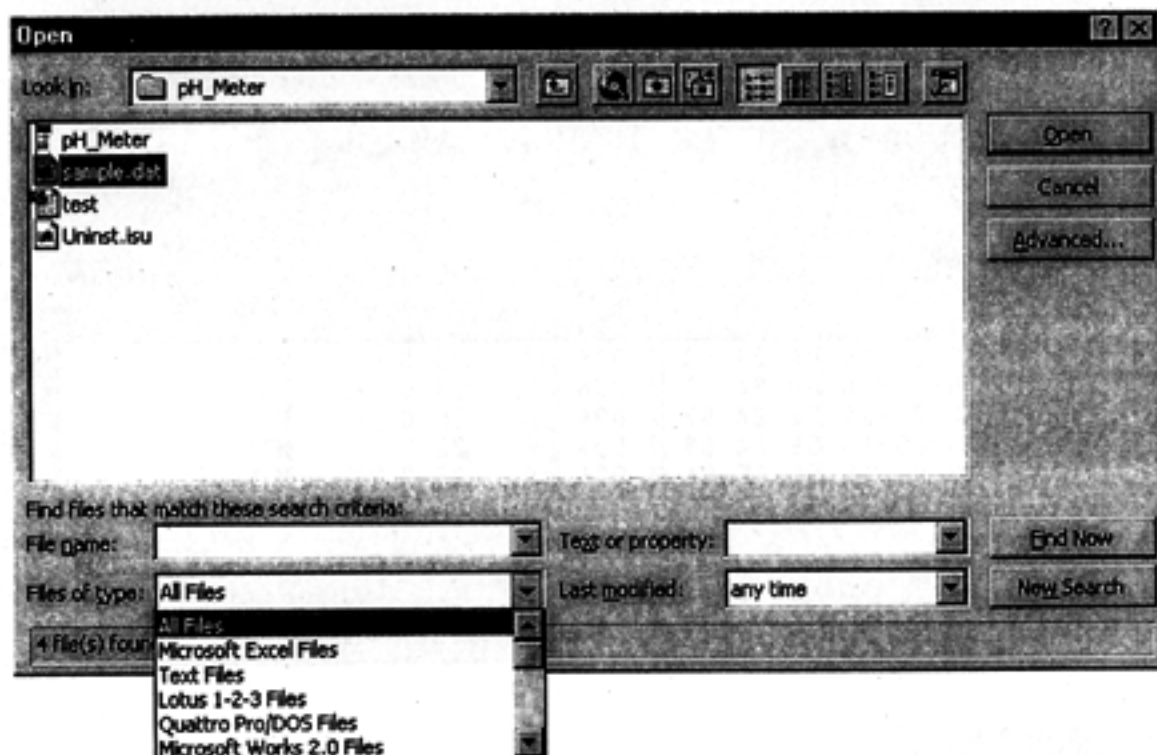

- ② The " Test Import Wizard " then appears, click finish button, the selected data will show in excel type.

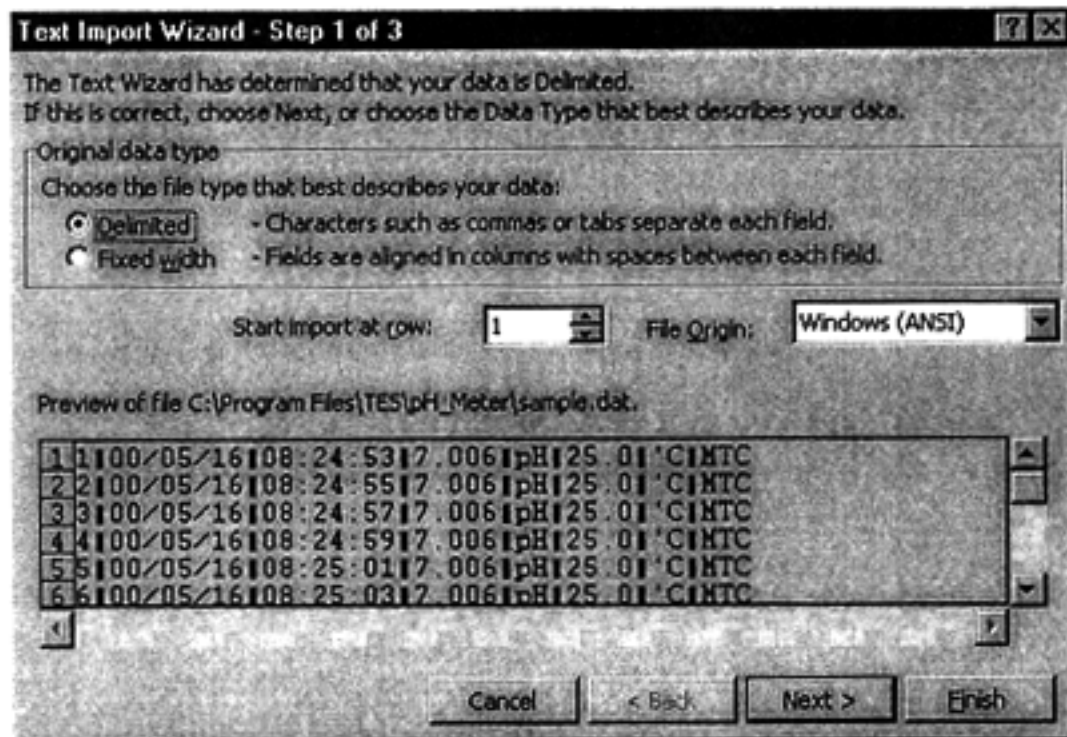

click " Next "

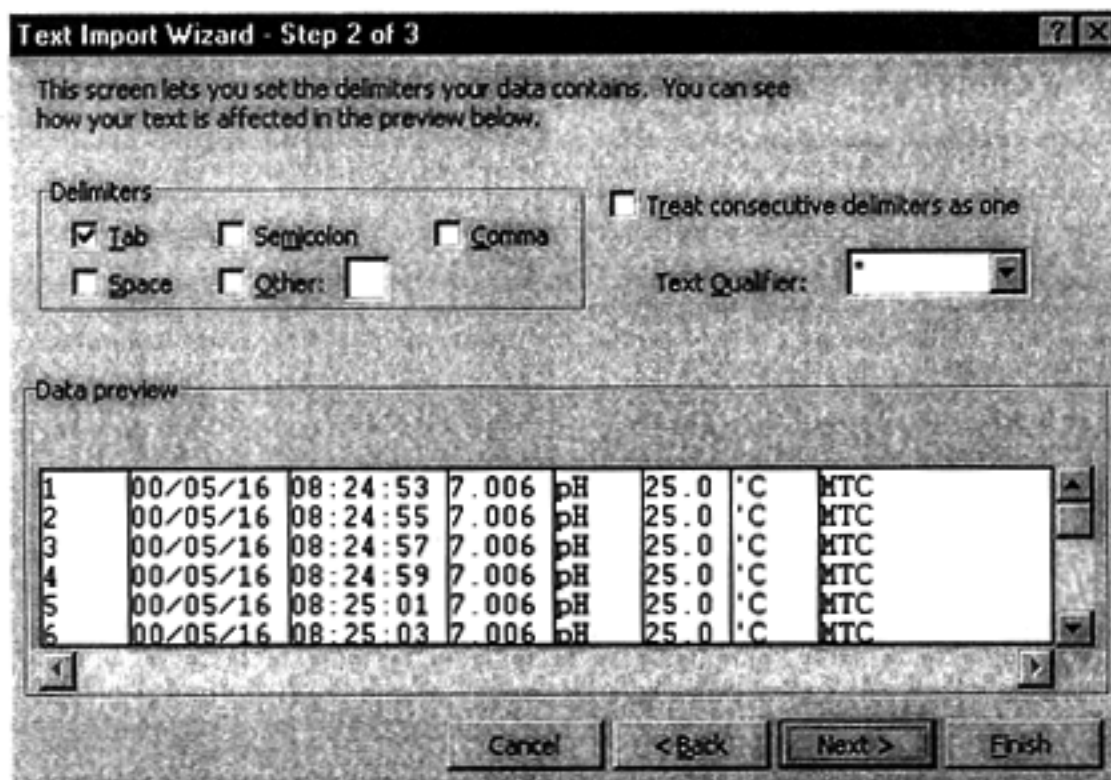

click " Next "



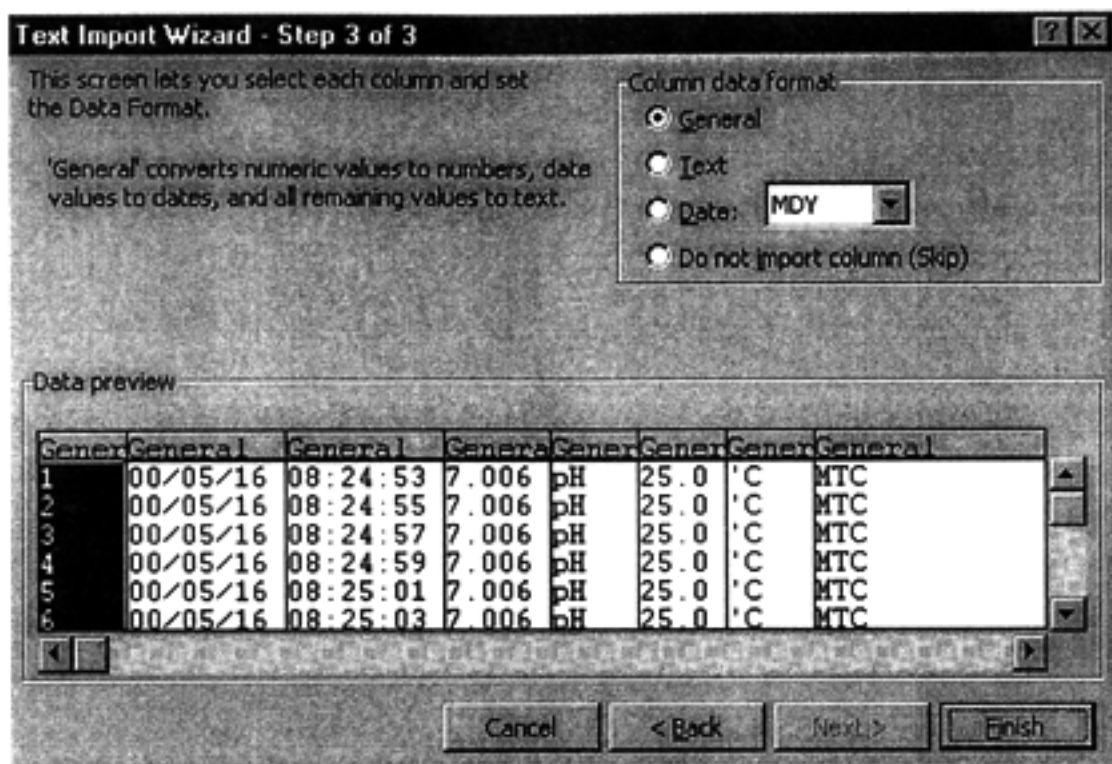

click " Next "



	A	B	C	D	E	F	Comma Style	H
1	1	00/05/16	8:24:53	7.006	pH	25 'C		MTC
2	2	00/05/16	8:24:55	7.006	pH	25 'C		MTC
3	3	00/05/16	8:24:57	7.006	pH	25 'C		MTC
4	4	00/05/16	8:24:59	7.006	pH	25 'C		MTC
5	5	00/05/16	8:25:01	7.006	pH	25 'C		MTC
6	6	00/05/16	8:25:03	7.006	pH	25 'C		MTC
7	7	00/05/16	8:25:05	7.006	pH	25 'C		MTC
8	8	00/05/16	8:25:07	7.006	pH	25 'C		MTC
9	9	00/05/16	8:25:09	7.006	pH	25 'C		MTC

## 10-5 Communicating Operation

- 1). Switch off all power related to your PC.
- 2). Connect the socket (female) of RS-232 cable to PC's COM1 or COM2 commport.
- 3). Switch on all power.
- 4). Connect the socket (male) of RS-232 cable to pH Meter.
- 5). Run the pH Meter software  
Click " Start " from Start menu, move mouse pointer to "Programs", then move pointer to " Tes" (default), move mouse pointer to "pH Meter" then click.

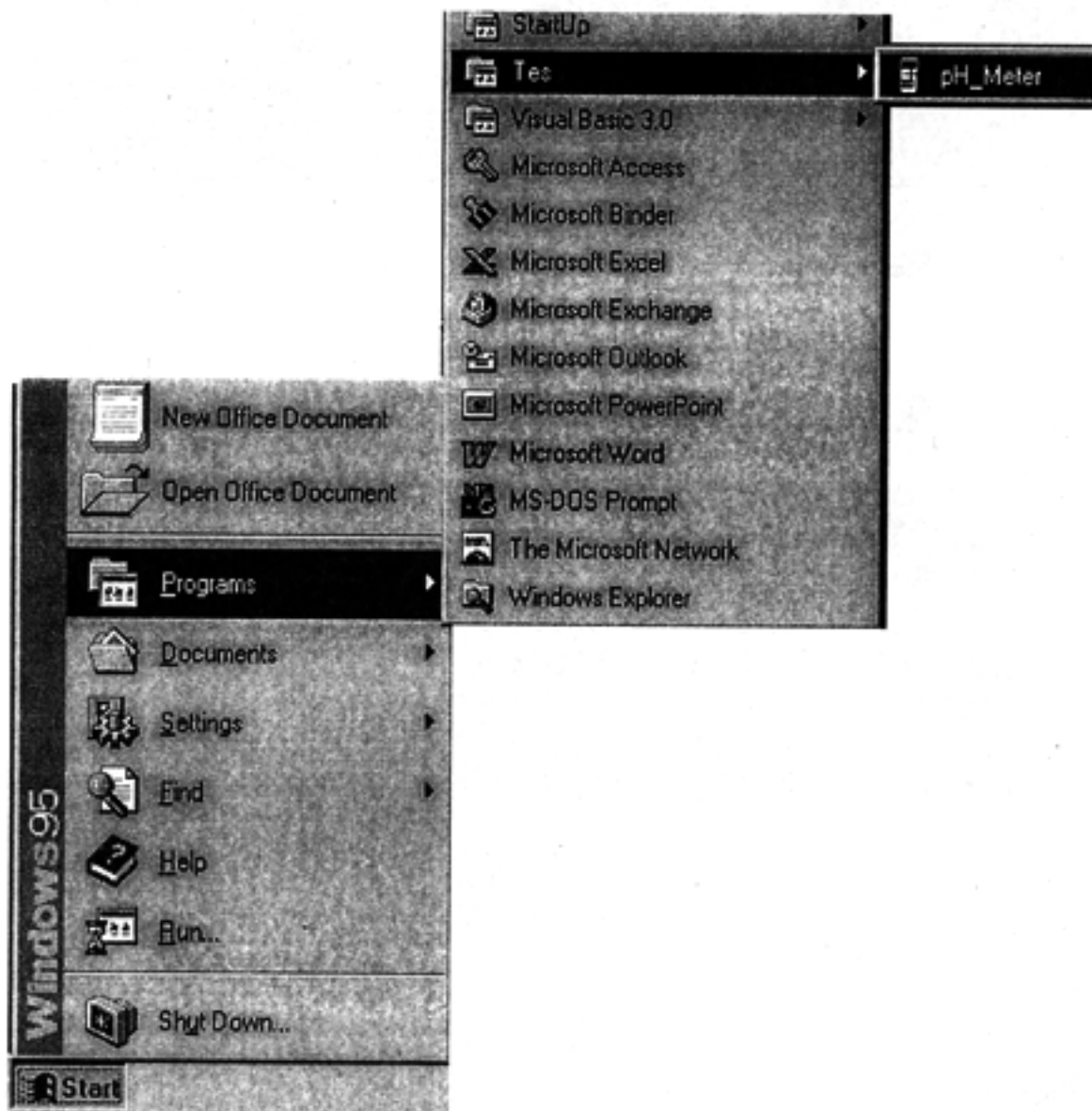

- 6). Move mouse to available commport (COM1 , COM2) then click.

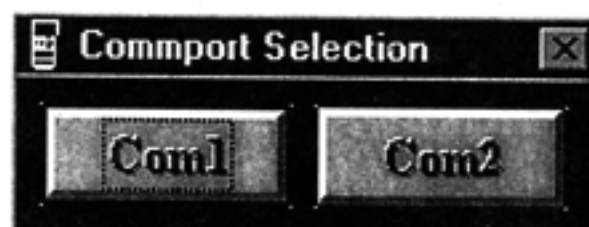

## 7). Main tableau



- ① Time Settings : Move mouse pointer to **Time Set** and click it to input the time of PC to the pH Meter..
- ② PC SAMPLING : (Default : 2 seconds). Change the sampling time of PC.

Move mouse pointer to **Sampling**. The dialog box - "Input Sampling Time" will be shown. Input the sampling time that you intend to set, then click "OK" to complete this setting.

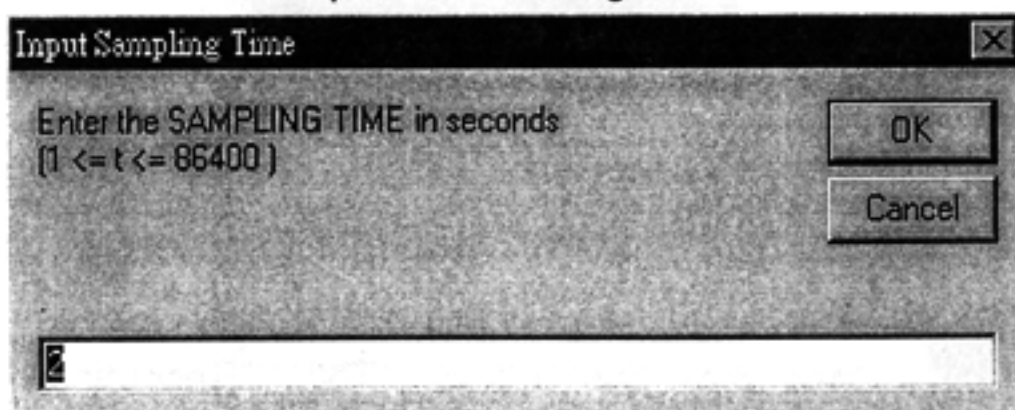



- ③ Move mouse pointer to **Save As** then click this button. You can find the " Save As " dialog box, please change to new file name : \*.xls from original file \*.dat then press enter. For example : test.xls



In " File Name ", the file name C:\...\TEST.XLS will be displayed.

- ④ In "Recording" column, the No.of PC record will be displayed from 1 up to end.
- ⑤ If user intend to end this record, please move mouse pointer to **Stop Rec**, then click this button. The " Recording " signal will disappear.

- ⑥ Move mouse pointer to **Open File** then click this button. There comes a dialog box to open file. Input the saved file name to read.

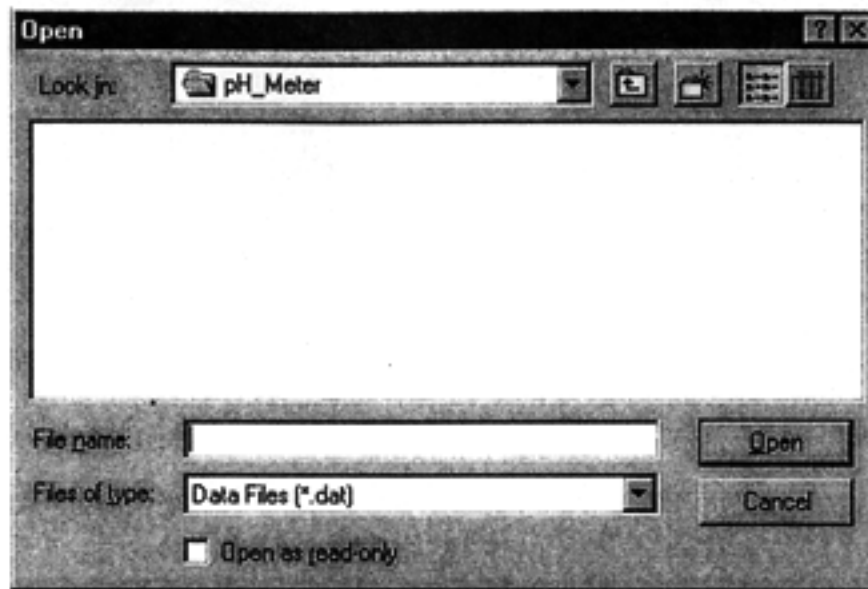

- ⑦ To show reading values in "GRAPH" type, move mouse pointer to **pH/mV** / **'C/F** then click. Choose the unit if willing to read.

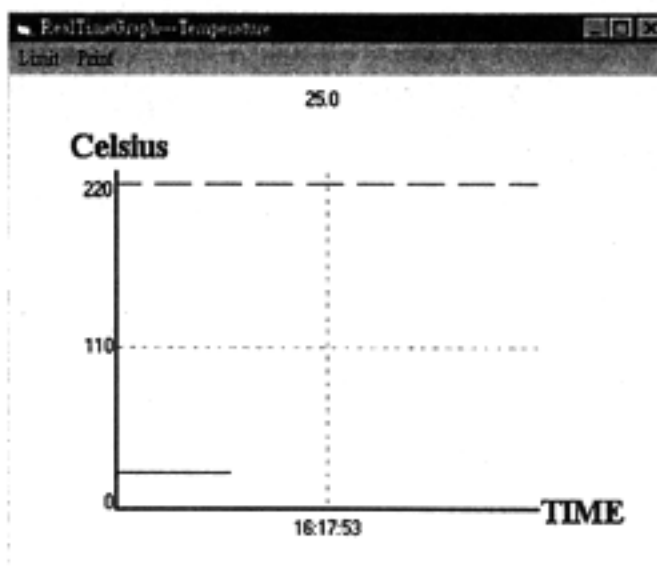
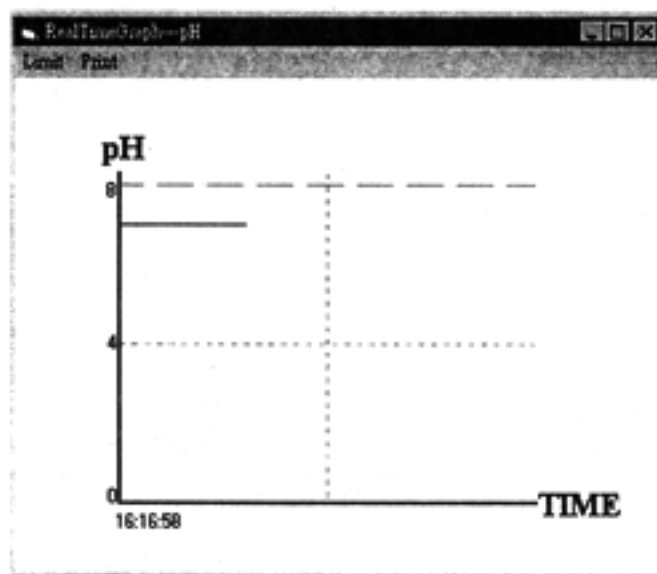

- ⑧ To show reading values in LIST type, move mouse pointer  and then click this button to launch.

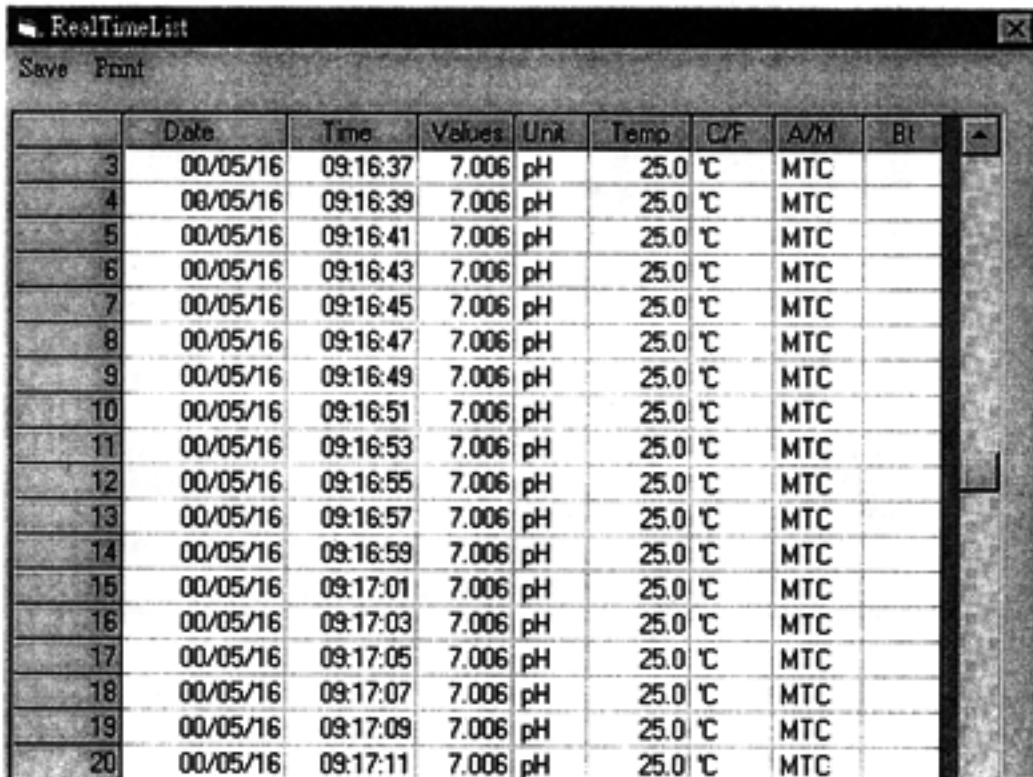



The screenshot shows a window titled "RealTimeList" with a menu bar containing "Save" and "Print". Below the menu bar is a table with the following columns: "Date", "Time", "Values", "Unit", "Temp", "C/F", "A/M", and "Bl". The table contains 18 rows of data, all showing a pH value of 7.006 and a temperature of 25.0 °C. The date is consistently 00/05/16 and the time progresses from 09:16:37 to 09:17:11. The "A/M" column is set to "MTC".

	Date	Time	Values	Unit	Temp	C/F	A/M	Bl
3	00/05/16	09:16:37	7.006	pH	25.0	°C	MTC	
4	00/05/16	09:16:39	7.006	pH	25.0	°C	MTC	
5	00/05/16	09:16:41	7.006	pH	25.0	°C	MTC	
6	00/05/16	09:16:43	7.006	pH	25.0	°C	MTC	
7	00/05/16	09:16:45	7.006	pH	25.0	°C	MTC	
8	00/05/16	09:16:47	7.006	pH	25.0	°C	MTC	
9	00/05/16	09:16:49	7.006	pH	25.0	°C	MTC	
10	00/05/16	09:16:51	7.006	pH	25.0	°C	MTC	
11	00/05/16	09:16:53	7.006	pH	25.0	°C	MTC	
12	00/05/16	09:16:55	7.006	pH	25.0	°C	MTC	
13	00/05/16	09:16:57	7.006	pH	25.0	°C	MTC	
14	00/05/16	09:16:59	7.006	pH	25.0	°C	MTC	
15	00/05/16	09:17:01	7.006	pH	25.0	°C	MTC	
16	00/05/16	09:17:03	7.006	pH	25.0	°C	MTC	
17	00/05/16	09:17:05	7.006	pH	25.0	°C	MTC	
18	00/05/16	09:17:07	7.006	pH	25.0	°C	MTC	
19	00/05/16	09:17:09	7.006	pH	25.0	°C	MTC	
20	00/05/16	09:17:11	7.006	pH	25.0	°C	MTC	

- ⑨ To read recorded data in memory (EEPROM).

a). Single Record :

- ⇒ Move mouse pointer to  and then click this button.  
A "Memory" window appears.



The screenshot shows a window titled "Memory" with the following information displayed:

- MemorySize:** 32.0 K
- Remaining:** 9.4K
- Time of Meter:** 00/05/11 — 10:45:08
- Single Record** (button)
- Sampling:** 1 sec

As above, the total memory size is 32K, 9.4K is remained. The inner time of pH Meter is 00/05/11-10:45:08.



⇒ In the "Memory" window, move mouse pointer to **Single Record** (at the left bottom corner of "Memory" window) then click to read.

	Date	Time	Values	Unit	Temp	C/F	A/M	Bit
1	00/05/08	08:38:01	9.708	pH	25.0	°C	MTC	
2	00/05/08	08:38:23	7.096	pH	25.0	°C	MTC	
3	00/05/08	08:38:28	8.741	pH	25.0	°C	MTC	
4	00/05/08	08:38:32	10.396	pH	25.0	°C	MTC	
5	00/05/08	11:53:20	5.648	pH	25.0	°C	MTC	
6	00/05/08	12:00:08	6.820	pH	25.9	°C	ATC	
7	00/05/08	12:06:47	6.824	pH	28.9	°C	ATC	
8	00/05/08	12:09:47	6.800	pH	26.6	°C	ATC	

b). MultiRecords :

⇒ Move mouse pointer to **Multi Rec** and then click this button. A "Memory" window appears.

Memory window showing:

- MemorySize: 32.0 K
- Remaining: 9.4K
- Time of Meter: [Empty field]
- Sampling: 1 sec
- Progress bar: 2%



Memory window showing:

- MemorySize: 32.0 K
- Remaining: 9.4K
- Time of Meter: [Empty field]
- Sampling: 1 sec
- Records list:
 

1	00/05/08	08:37/30
2	00/05/08	08:38/07
3	00/05/08	11:53/28
4	00/05/08	11:59/51
5	00/05/08	12:00/25
6	00/05/08	12:00/47
7	00/05/08	12:01/20
8	00/05/08	12:06/55
9	00/05/08	12:15/28
10	20/00/21	07:33/31

The blue bar will display downloaded percentage please wait while downloading.

As above, the total memory size is 32K, 9.4K remained.

The inner time of pH Meter is 00/05/11-10:45:08.

⇒ Move mouse pointer to the listed record and then click if willing to read.

The 'Memory' window displays the following information:

- MemorySize:** 32.0 K
- Remaining:** 9.4K
- Time of Meter:** (Empty field)
- Sampling:** 1 sec
- Record List:**

1	00/05/08	08:37/30
2	00/05/08	08:38/07
3	00/05/08	11:53/28
4	00/05/08	11:59/51
5	00/05/08	12:00/25
6	00/05/08	12:00/47
7	00/05/08	12:01/20
8	00/05/08	12:06/55
9	00/05/08	12:15/28
10	20/00/21	07:33/31



The 'DataList' window shows the following table:

171 Records Completed								
	Date	Time	Values	Unit	Temp	C/F	A/M	Bt
1	00/05/08	12:06:55	6.896	pH	25.0	°C	MTC	
2	00/05/08	12:06:56	6.896	pH	28.6	°C	ATC	
3	00/05/08	12:06:57	6.874	pH	28.6	°C	ATC	
4	00/05/08	12:06:58	7.022	pH	28.6	°C	ATC	
5	00/05/08	12:06:59	7.022	pH	28.5	°C	ATC	
6	00/05/08	12:07:00	6.998	pH	28.5	°C	ATC	
7	00/05/08	12:07:01	6.846	pH	28.5	°C	ATC	
8	00/05/08	12:07:02	6.846	pH	28.5	°C	ATC	
9	00/05/08	12:07:03	6.823	pH	28.5	°C	ATC	
10	00/05/08	12:07:04	6.808	pH	28.5	°C	ATC	
11	00/05/08	12:07:05	6.808	pH	28.4	°C	ATC	
12	00/05/08	12:07:06	6.792	pH	28.4	°C	ATC	
13	00/05/08	12:07:07	6.792	pH	28.4	°C	ATC	
14	00/05/08	12:07:08	6.804	pH	28.3	°C	ATC	
15	00/05/08	12:07:09	6.815	pH	28.3	°C	ATC	
16	00/05/08	12:07:10	6.815	pH	28.3	°C	ATC	
17	00/05/08	12:07:11	6.825	pH	28.3	°C	ATC	
18	00/05/08	12:07:12	6.833	pH	28.2	°C	ATC	
19	00/05/08	12:07:13	6.833	pH	28.2	°C	ATC	
20	00/05/08	12:07:14	6.839	pH	28.2	°C	ATC	

**SAVE** : To save recorded data in HDD applying for other applications such as EXCEL, WORD. For example, P.23.

- Move mouse pointer to " Save " then click this button.
- A dialog box will come up. Input the name of the file if user intend to save as.
- Click " Save ".

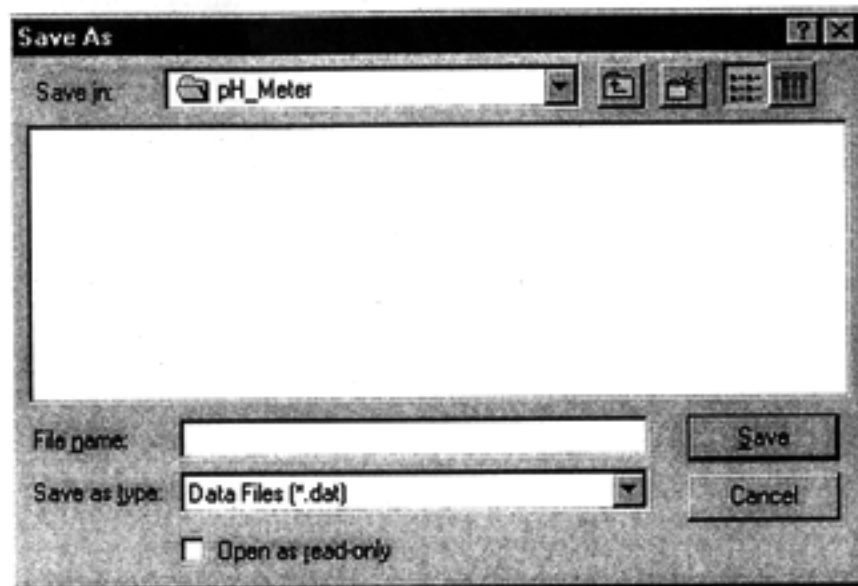



**TES ELECTRICAL ELECTRONIC CORP.**

Add: 7F, No. 31, Lane 513, Rui Guang Road, Neihu Dist. Taipei.  
Taiwan, R. O. C.

Tel : (02) 2799-3660

Fax : 886-2-2799-5099

E-Mail : tes@ms9.hinet.net

Home page: <http://www.tes.com.tw>

---