

# 취급설명서

Hydrological Equipment  
GPI



SECHANG INSTRUMENTS

3 (Price or Pygmy),  
 (Cable or Rod), (Headphone, 1100 ,611 ). 37+

6

Part 1:

Part 2:

Part 3: Price, Pygmy meter

Part 4: 1100

Part 5:

Part 6: Repair Parts

## Part 1 –

Genuine Gurley , , ,

### 1.1

625 622 (Wheel) 6 가 .  
**Pygmy** ( 76mm) .  
 Pygmy 51mm .  
**Price** 가 Rod 가 152mm,  
 475mm .  
 Price 127mm .

## **Part 2 –**

(Headphones, Model 1100, Model 611)

(Cable Suspension System)

(Rod Suspension System)

3.

3.1

(Model 622 or D622 Price Meter)

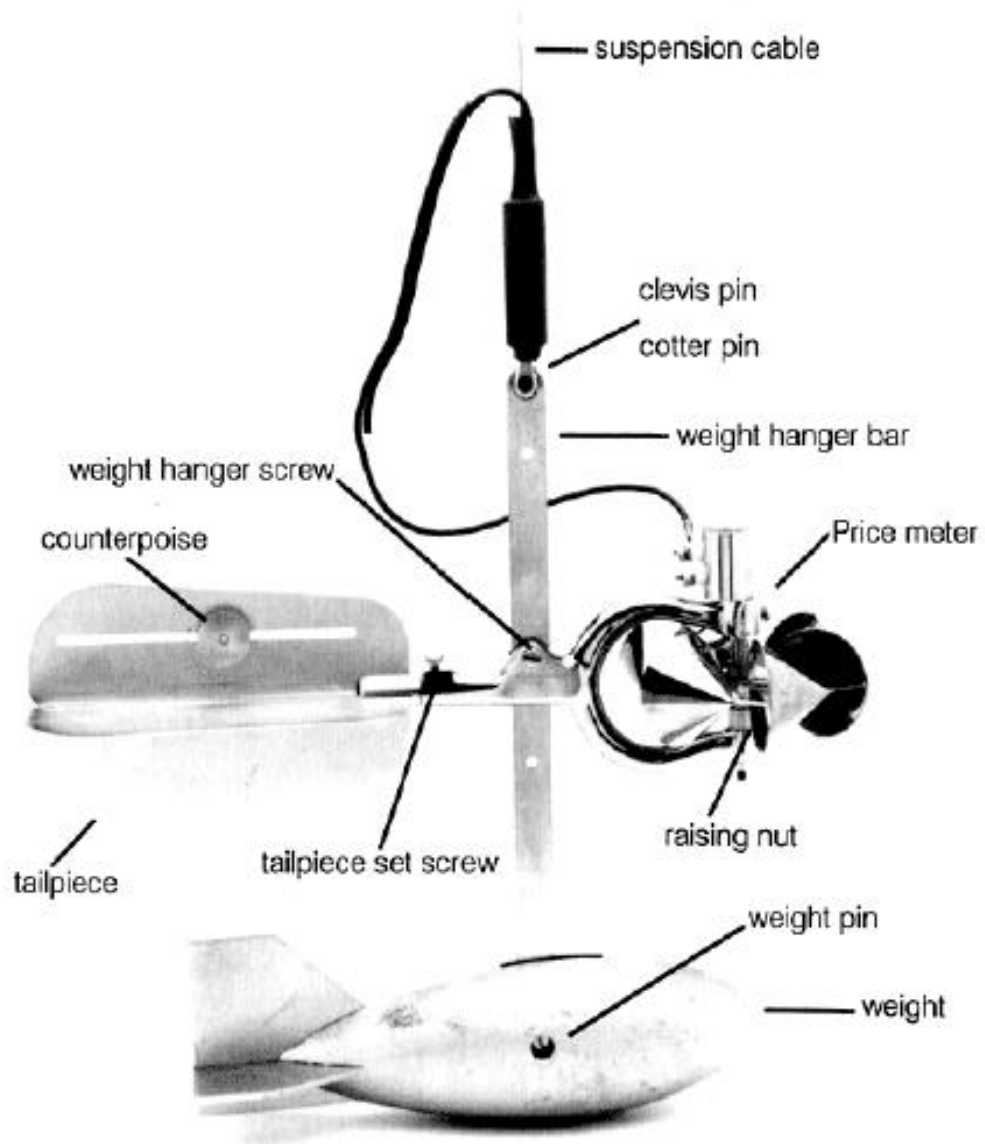

*Model 622E Shown*

1 Clevis Pin Cotter Pin 50

2 Weight hanger bar

.50

, Clevis Pin

Cotter Pin

3

Price Meter

Weight Hanger Screw

Weight Hanger Bar Weight Hanger Screw가

Price Meter Bar

Weight Hanger Screw

4 Weight Hanger Bar

, Weight Pin

5 Tailpiece

. Tailpiece Price Meter

, Tailpiece Set

Screw

6

Raising nut

“ ”

### 3.2 Headphones

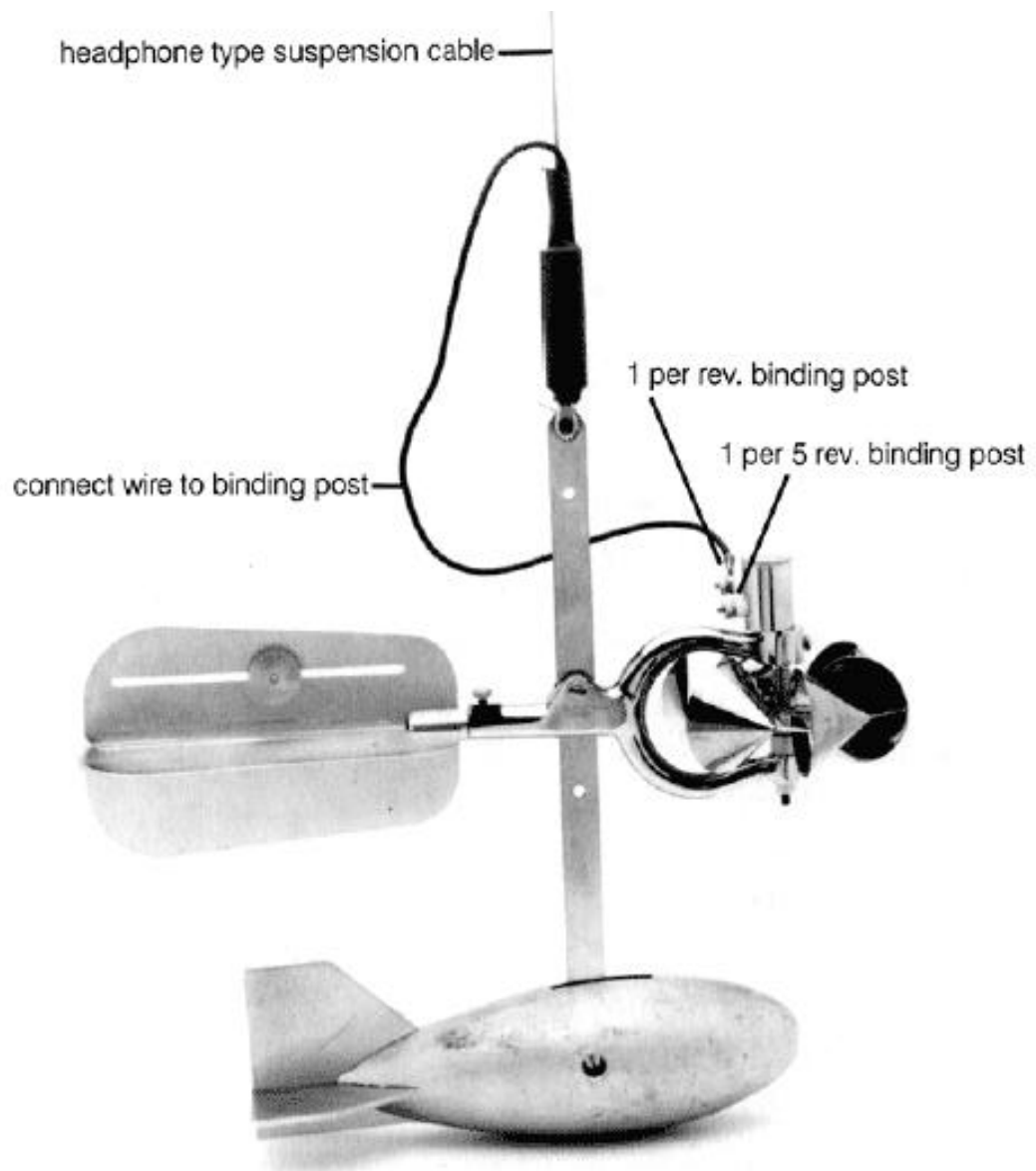

*Model 622E Shown*

				Price
<b>1</b>	Weight Hanger Bar	Meter	,	
	Meter	Binding Post	.	Binding Post 1 ,
		Binding Post 5	.	
<b>2</b>		/	.	
	Meter		가	.
	가		.	
1-			.	
2-			.	
3-	Contact wire	(5.4	)	
Price Meter		,	,	.

3.3

1100

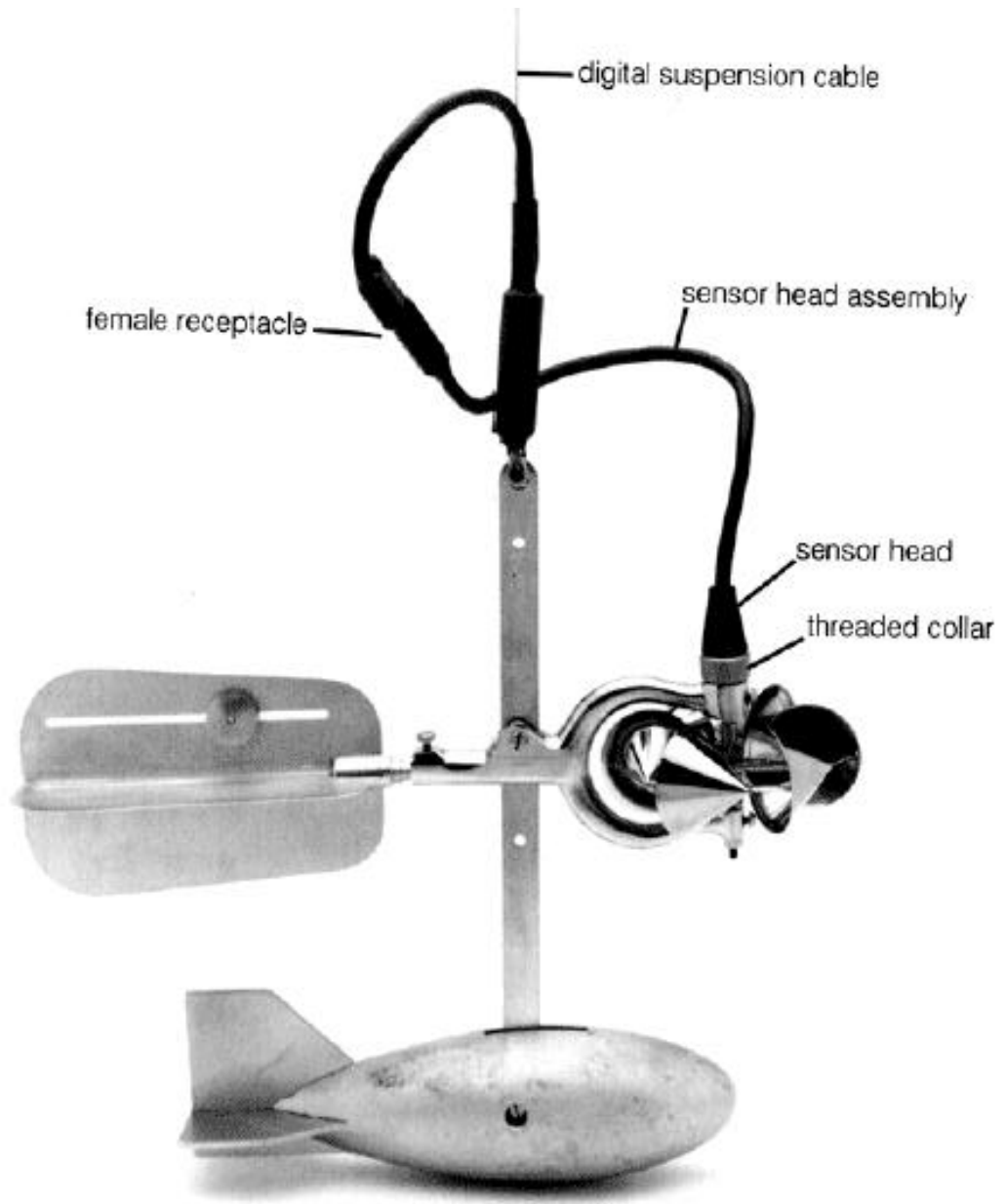



- 1** Sensor Head Assembly Meter Sensor Head  
 Plug Male
- 2** Meter Weight Hanger Bar , Meter Sensor Head  
 Assembly Plug Sensor Head Assembly Plug  
 Meter Threaded Collar
- 3** Sensor Head Assembly Male “ ”
- 4** Digital Suspension Cable 4  
 1100
- 5** 1100 ON 622

Feet per second	622 FS
Meters per second	622 MS

1100

Part4

### 3.4 611 Counter



611 ( , 622 & 625 Price Meter)

				Price
<b>1</b>	Meter	Weight Hanger Bar	,	
	Meter	Binding Post	(3.2 )	Binding Post
<b>1</b>		, Binding Post	5	.
<b>2</b>	611	Spade Connector	6V	.
<b>3</b>	611	Jack	.	
<b>4</b>				
<b>5</b>	611		,	
<b>6</b>	0	Reset	.	
	가		.	
1-			.	
2-	6V	.		
3-	Contact Wire	(33 )		
Price Meter	611	:		

#### 4. Wading Rod System( )

4.1 (Model 622 or D622 Price meter)

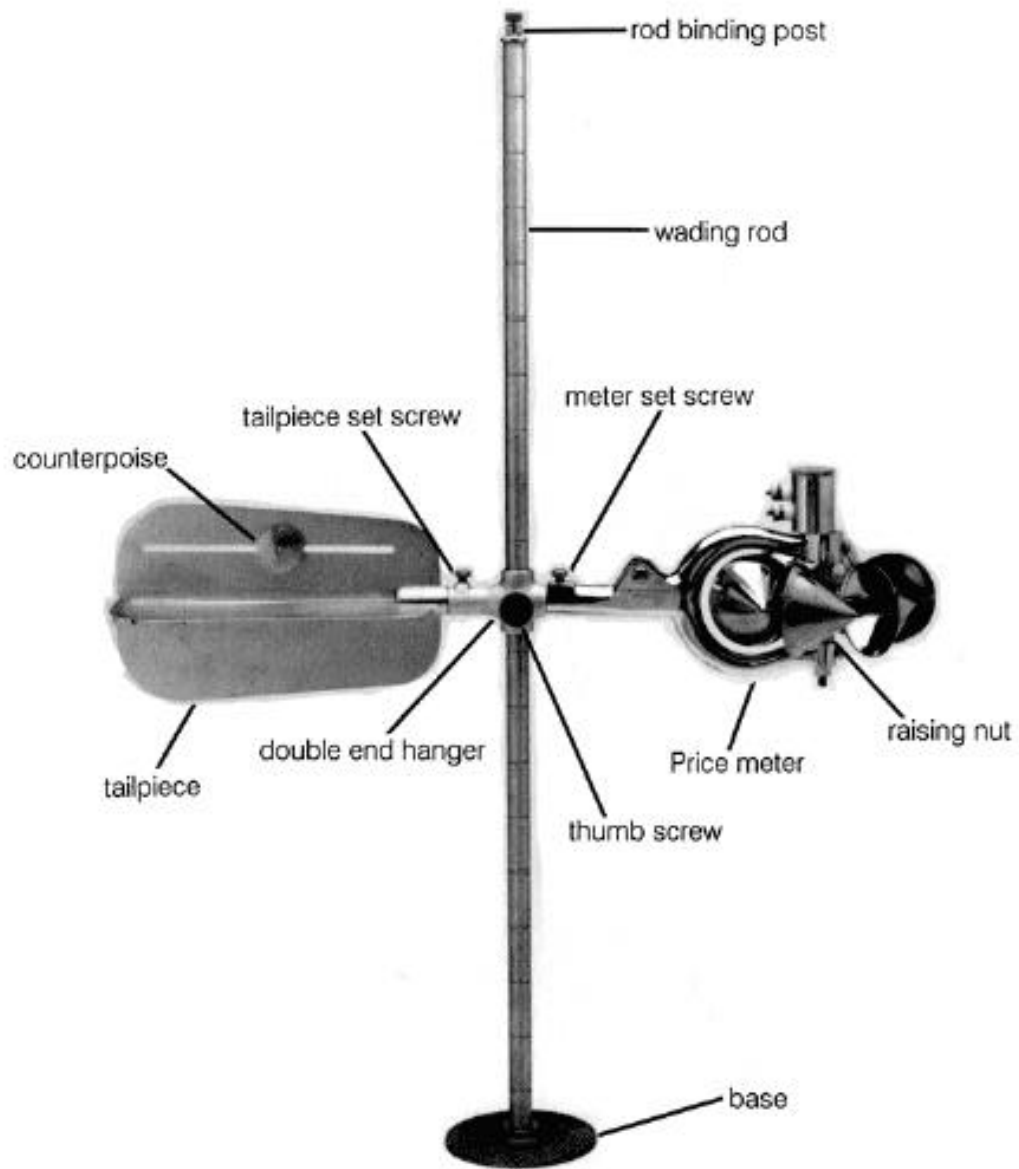

*Model 622F Shown*

622, D622

[ ]

**1** Base

**2** Double End Hanger

screw

Thumb

[Top-setting Rod ] Hanger가

**3** Meter Hanger

Meter Set Screw

**4** Tailpiece Hanger

Tailpiece set screw

**5** :

가

4.2

( Model 625 and D625 Pygmy Meter)

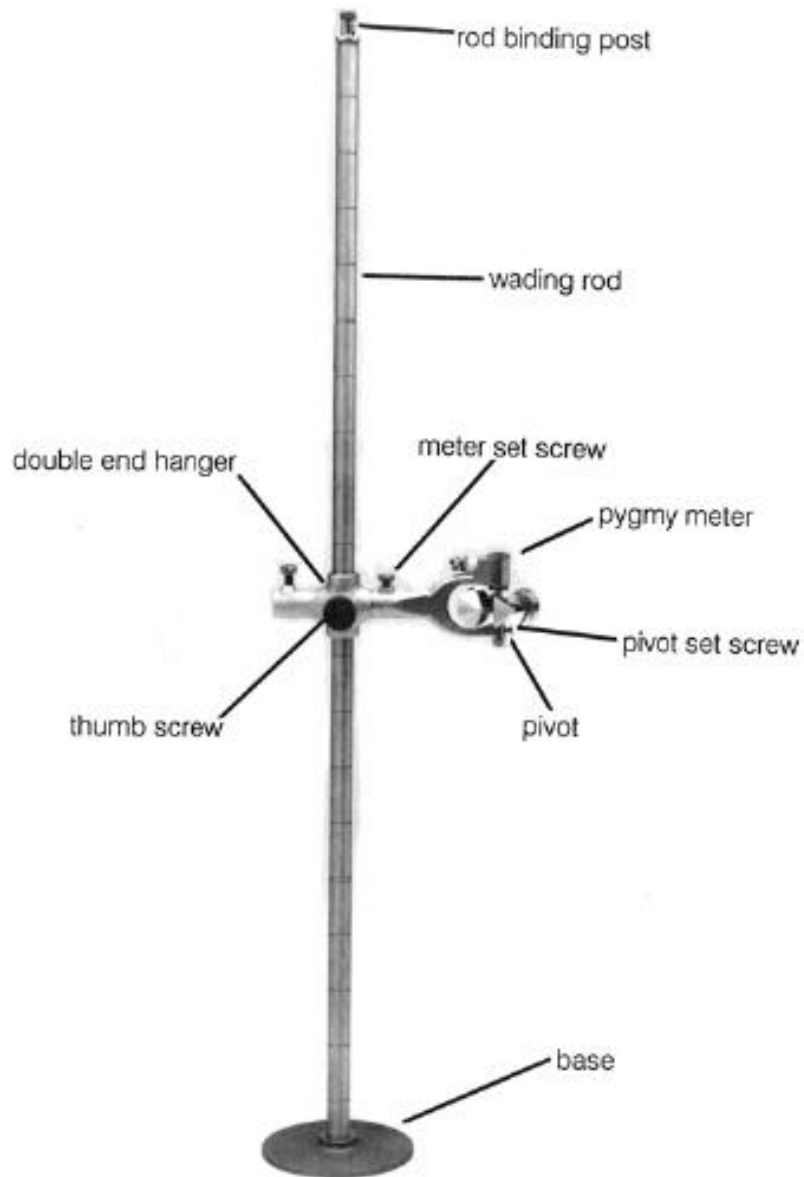

*Model 625F Shown*

625, D625 Pygmy Meter

[ ]

1 Base

2 Double End Hanger

Thumb

screw

[Top-setting Rod ] Hanger가

3 625 Pygmy Meter

4 ,

Shipping Pivot

Working Pivot

Pivot

Pygmy Meter

6.2

5 Pygmy Meter Hanger

6 : 가

4.3 ( Headphones )

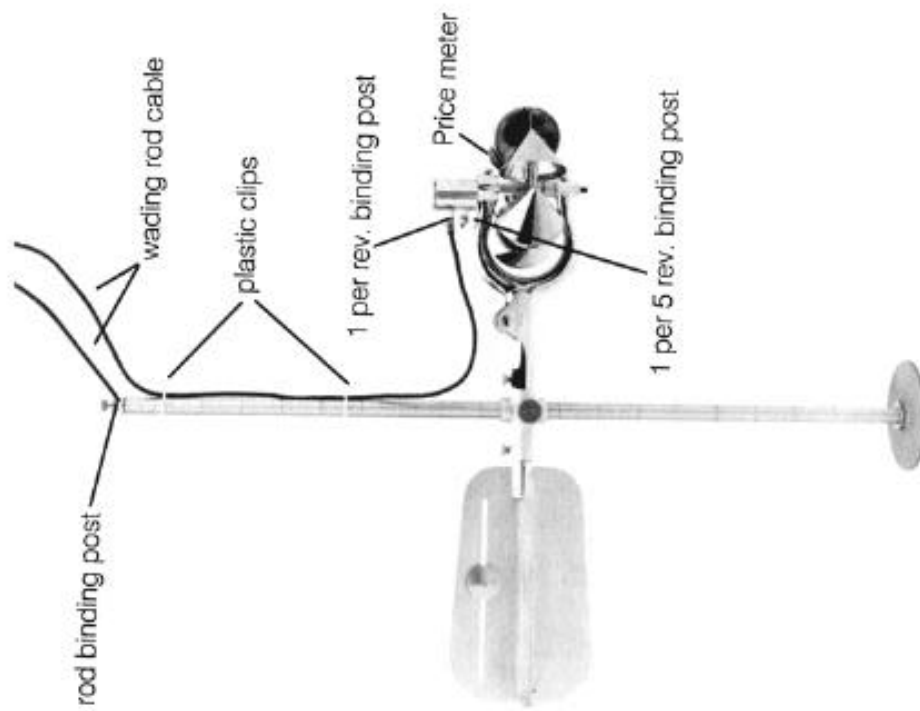



622 Price Meter      625 Pygmy Meter

**1** Wading Rod Cable      Meter      Binding post  
Price Meter      2      Binding post가  
Price Meter      Binding Post      1      ,      Binding Post      5  
   . Pygmy Meter      Binding post가      , 1

**2** Rod binding post      .      Wading Rod Cable

**3**

**4**

가

가

1-

2-

3- Contact Wire      (5.4 , 6.4      )

Price Meter      Pygmy Meter      ,

4.4 1100

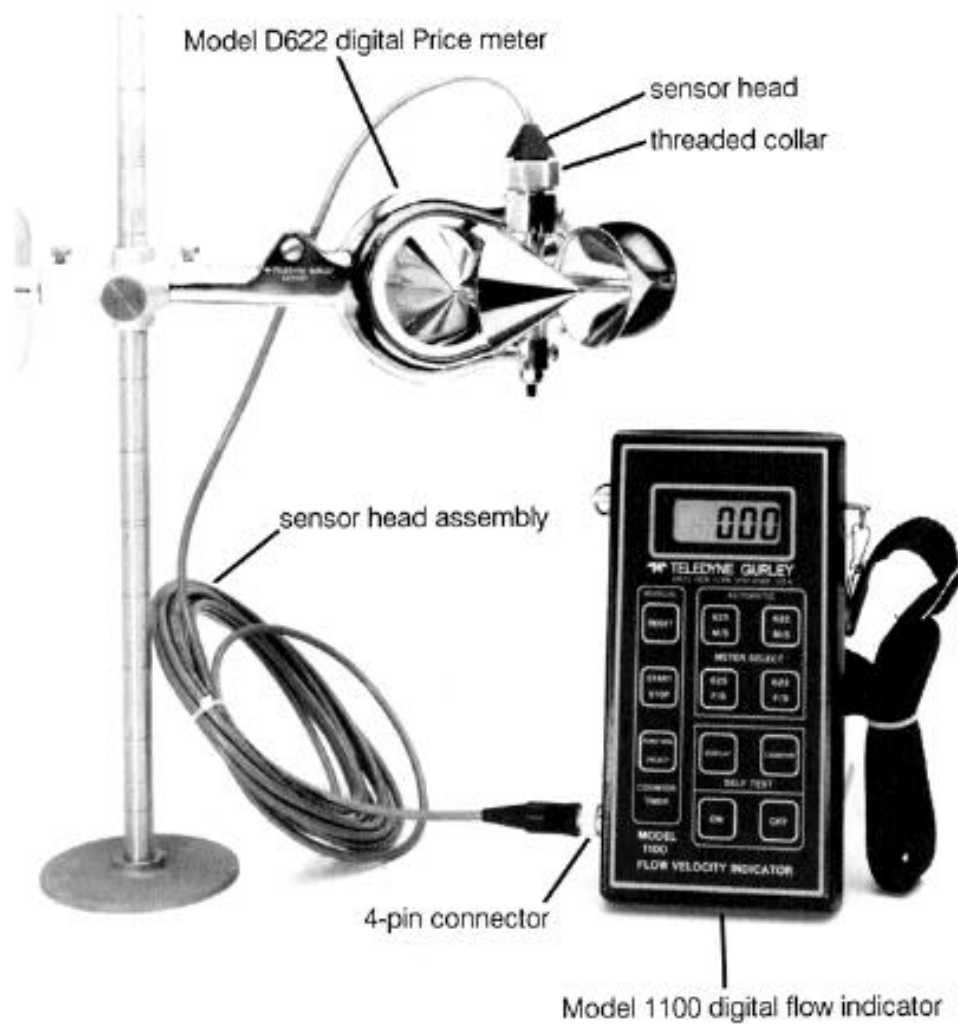

*Model D622F Shown*

1100 [ ] D622 Price Meter D625 Pygmy

Meter

**1** Meter Rotor

Housing Sensor head( )

**2** Sensor head Meter Rotor Housing Sensor head

Threaded collar

**3** 1100 4-pin Connector Threaded collar

**4** 1100

Meter Type		
Price 622	Feet per second	622 FS
Price 622	Meters per second	622 MS
Pygmy 625	Feet per second	625 FS
Pygmy 625	Meters per second	625 MS

Part4

4.5 ( 611 Counter )

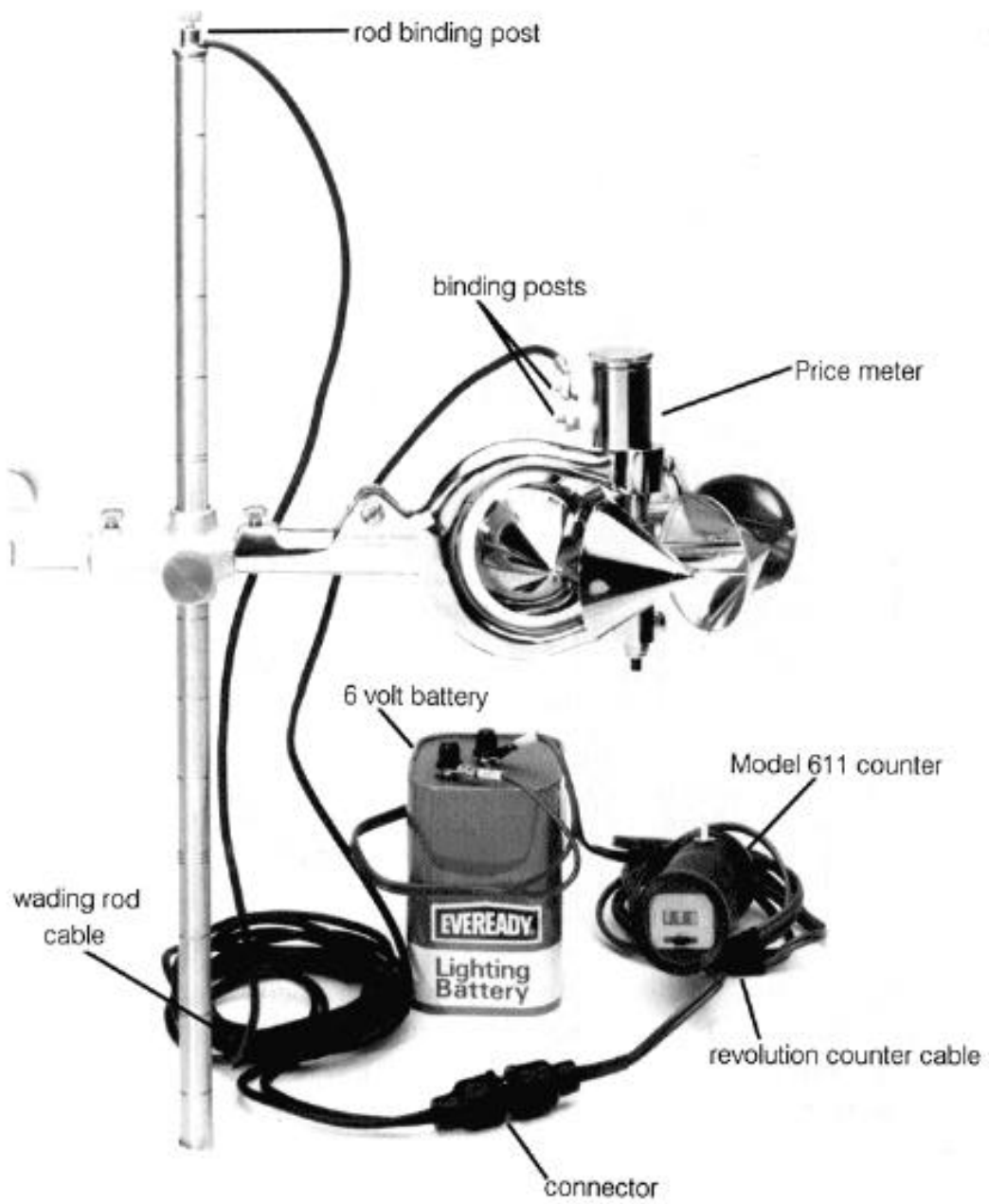

611 가 .

**1** (Wading rod cable) Binding post .

622 Price Meter 2 Binding post 가 . Binding post  
, 1 , Binding post 5 .

625 Pygmy Meter 1 Binding post가 .

**2** Rod binding post (Wading rod cable)

**3** 611 Spade connector 6V .

**4** 611 .

**5** (Wading rod cable) (male and female) 611

**6** 611 .

**7** Reset 611 0 .

611 가 , .

1- .

2- 6V .

3- Contact Wire (5.4 , 6.4 )

611 , .

### **Part 3 – Price, Pygmy meter**

# 5. Price Meter

## 5.1

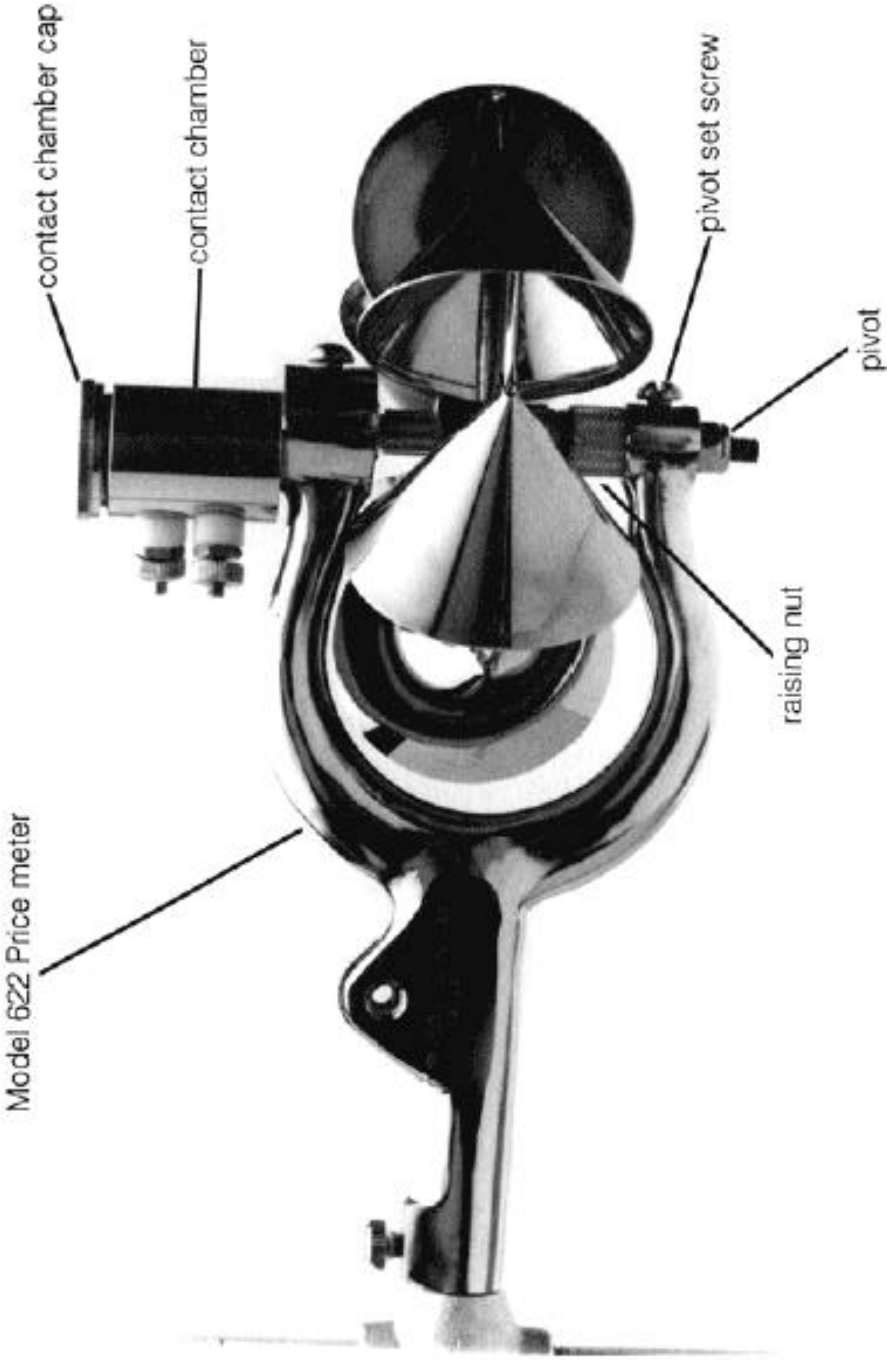

가

**1** Contact chamber cap( )

**2** Pivot set screw Pivot( )

**3** Pivot

**4** Pivot Meter Bearing

**5** Contact chamber,

Pivot Pivot 가  
Pivot  
, Pivot

**6** Contact chamber,

Contact chamber

**7** Contact chamber cap 가



**5.2 Pivot (622 Price meter, headphone style)(5.5 , 5.6 )**

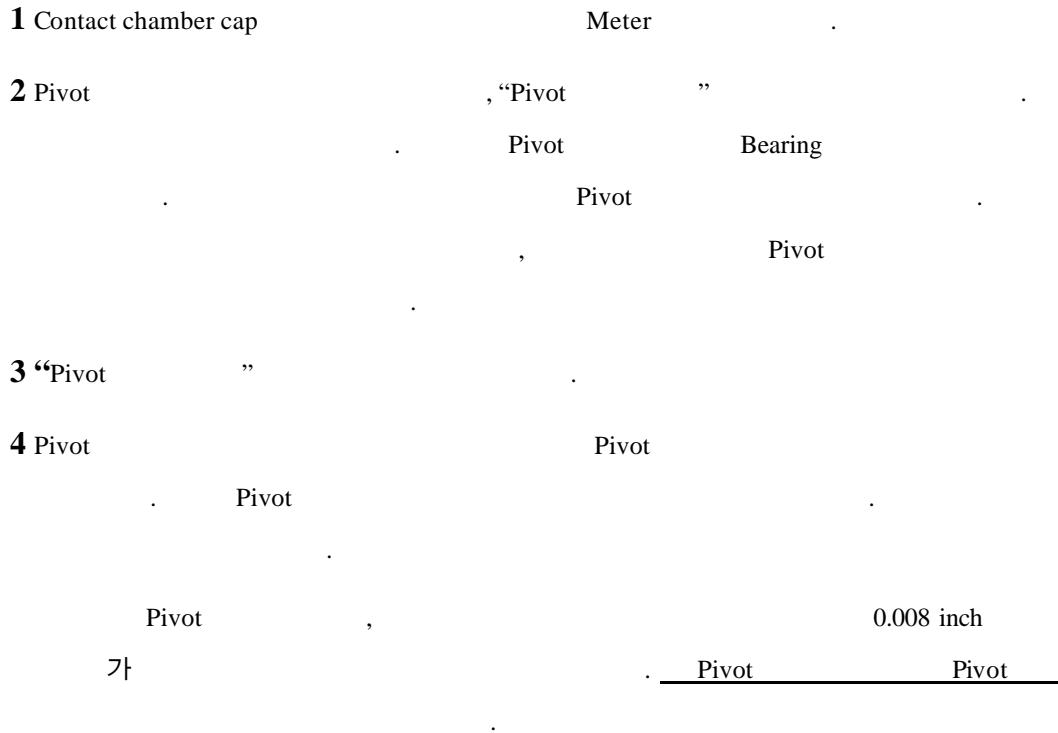

**5.3 Pivot ( D622 Price meter, digital style) (5.5 , 5.6 )**

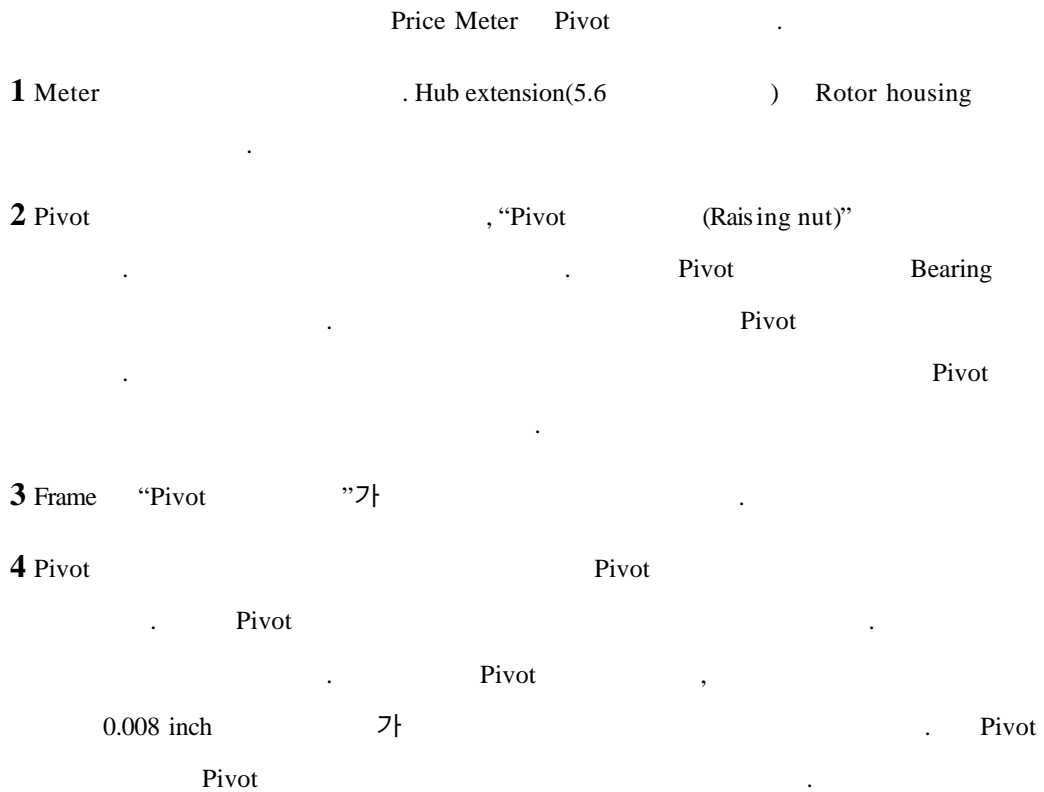

**5.4 Contact wire ( 622 Price meter, headphone style)**

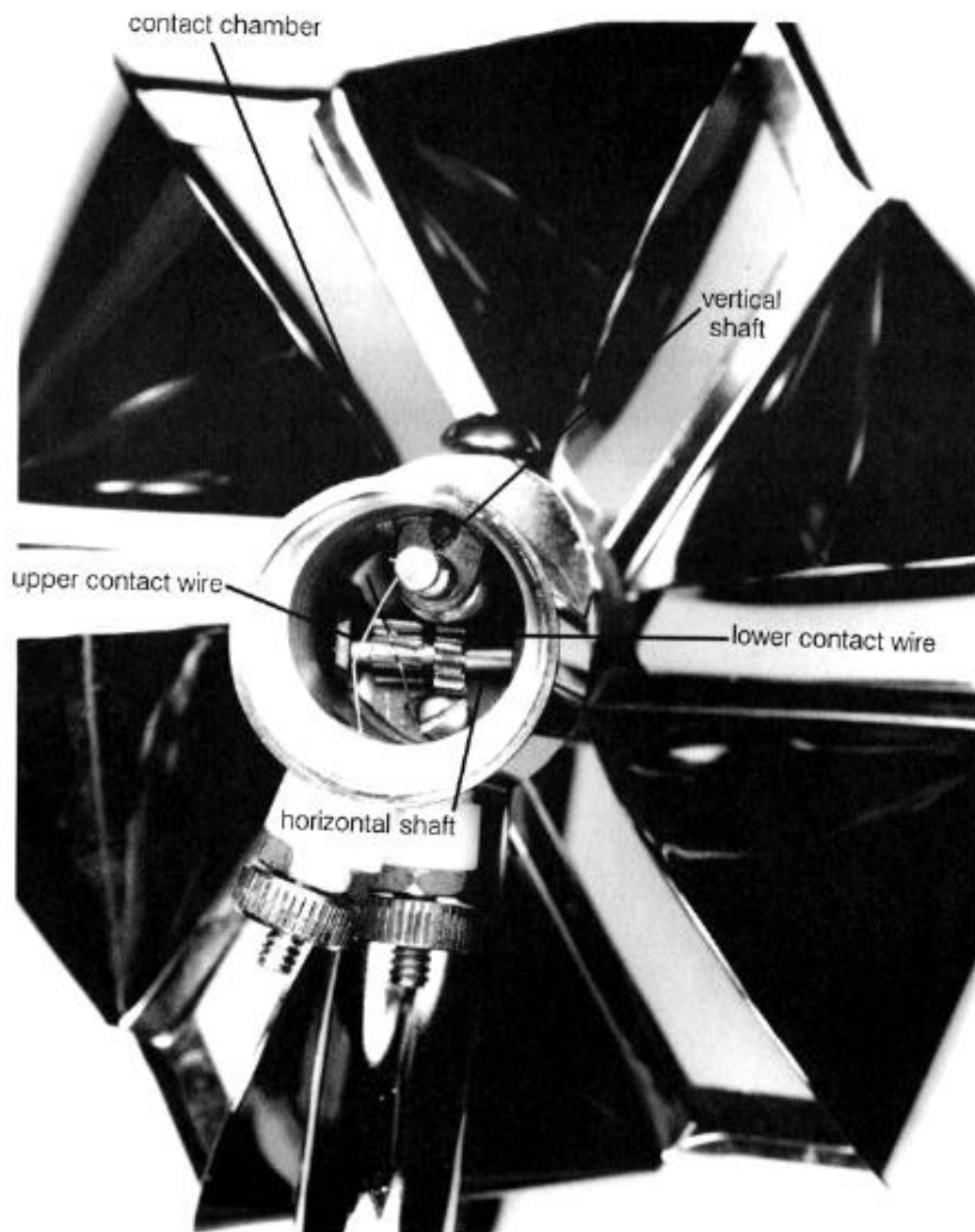

Contact wire . Shaft , Contact wire가  
 , 1 .  
 Price meter .

**1** Part 2 Meter . Meter  
 가 . 가  
 Contact wire .

**3** , Contact chamber cap .

Price meter Contact wire가 . Wire 1 , 1 ,  
 Wire 5 , 1 .

**4** “ shaft” Contact wire .  
 Shaft Contact lug . Wire .

**5** “ shaft” Raised lug 가 Lug Wire  
 .

**6** Contact chamber cap .

Pivot Contact wire 가  
 .

**5.5 Meter ( 622 Price meter, headphone style)**

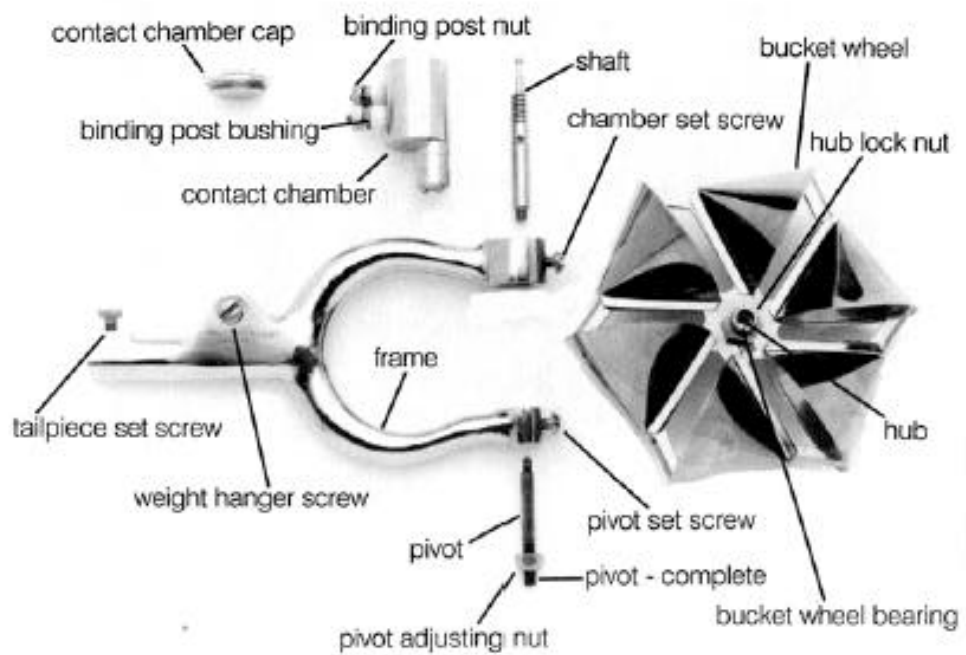
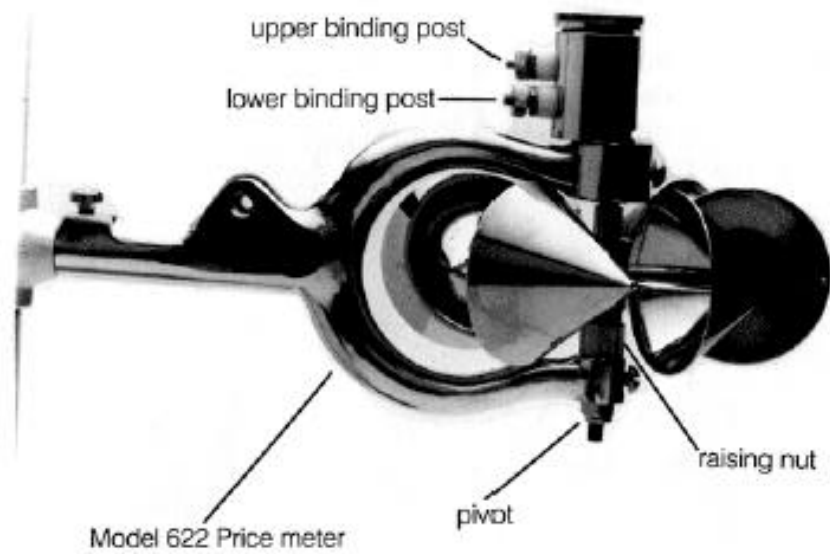

622 Price meter

**1** Contact chamber cap

**2** Pivot Contact chamber

**3** Pivot

**4** Contact chamber

**5** Shaft

Adjusting pin

“ ”

Shaft

**6** Frame

**7** Hub Assembly Hub luck nut

Hub bearing

---

5.6 Meter (D622 Price meter, digital style)

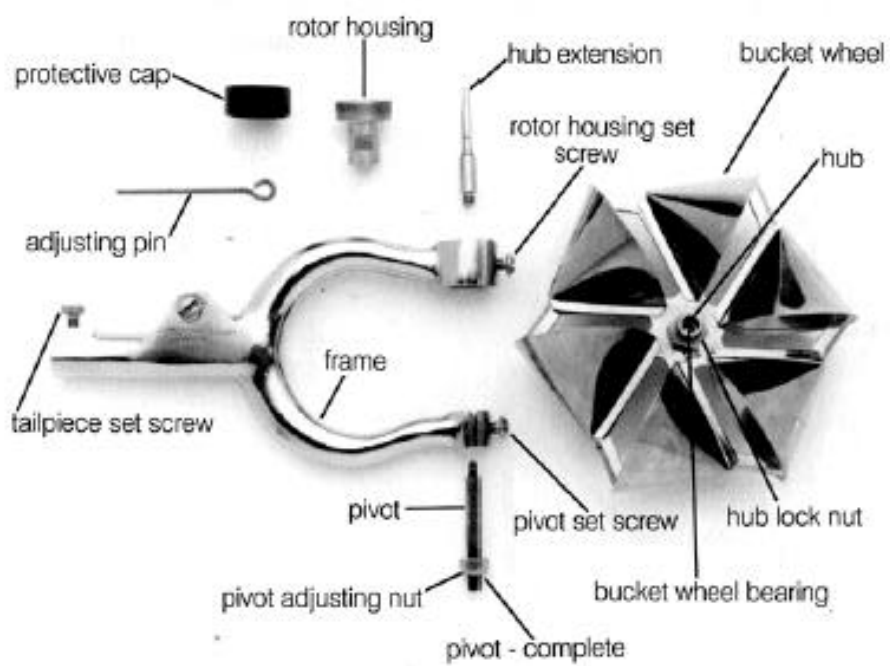
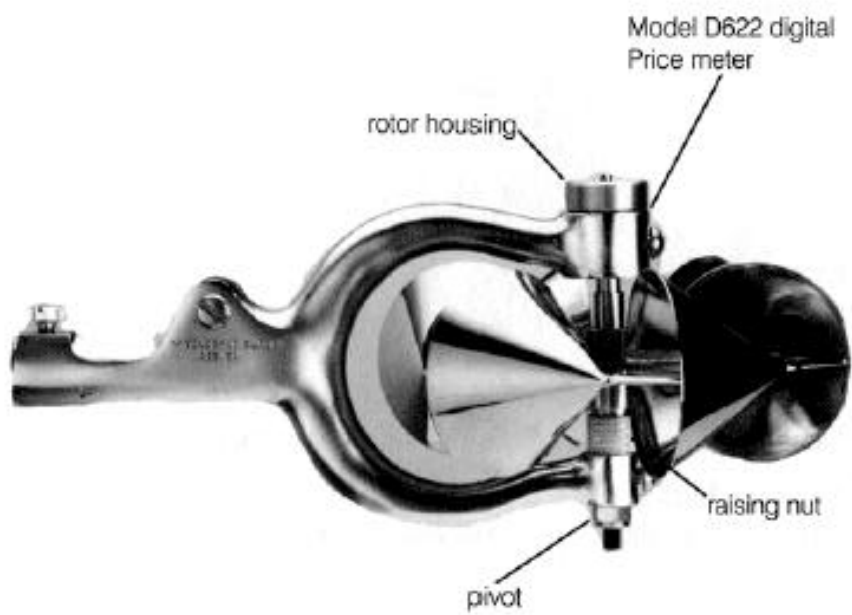

Price meter

**1** Pivot

**2** Pivot

**3** Rotor housing

**4** Rotor housing

**5** hub extension

Adjusting pin

“ ”

hub extension

**6** Frame

**7**

Hub Assembly

Hub luck nut

Hub bearing

## 6. Pygmy Meter

### 6.1

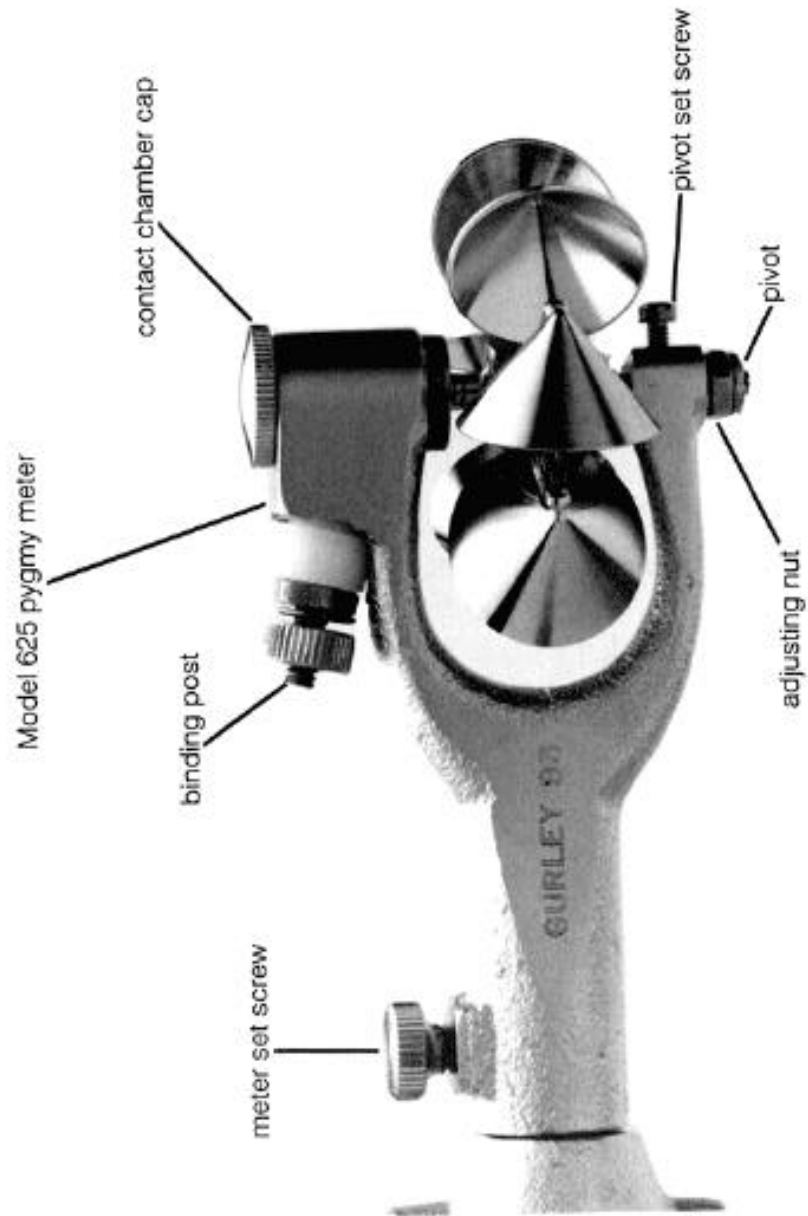



가

**1** Contact chamber cap( )

**2** Pivot Pivot Assembly( )

**3** Pivot

**4** Pivot 가 Bearing

**5** Contact chamber

, Pivot

**6** Contact chamber cap

Pygmy Meter Shipping Pivot 가

, Shipping Pivot Working Pivot

**6.2 Pivot ( 625 Pygmy meter, headphone style)(6.5 , 6.6 )**

Pygmy Meter

**1** Contact chamber cap

**2** Pivot , “Pivot ”  
Pivot Bearing  
Pivot  
Pivot

**3** Frame “Pivot ”가

**4** Pivot Pivot  
Pivot

Pivot , 0.008 inch  
가 Basket Wheel Pivot  
Pivot

**6.3 Pivot ( 625 Pygmy meter, digital style)(6.5 , 6.6 )**

**1** Meter . Hub extension(6.6 ) Rotor housing

**2** Pivot , “Pivot ”  
Pivot Bearing  
Pivot  
Pivot

**3** Frame “Pivot ”가

**4** Pivot Pivot  
Pivot

Pivot , 0.008 inch  
가 Basket Wheel Pivot  
Pivot

**6.4 Contact wire ( 625 Pygmy meter, headphone style)**

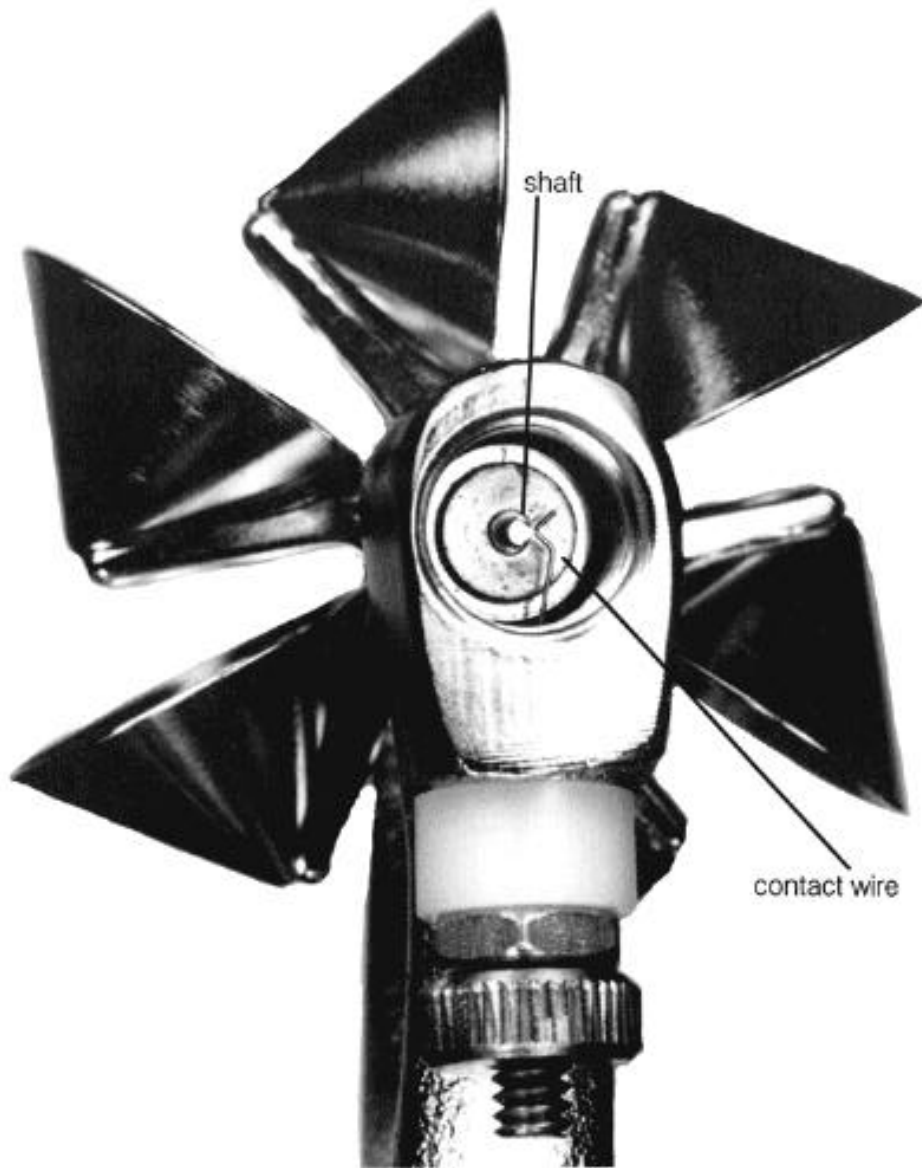

Contact wire . Shaft , Contact wire가  
 , 1 .  
 Pygmy meter .

**1** Part 2 Meter .

**2** Meter 가 .  
 가 Contact wire .

**3** , Contact chamber cap .

**4** Raised contact lug “ shaft”가 .  
 Wire .

**5** Contact chamber cap .

Pivot Contact wire 가

**6.5 Meter ( 625 Pygmy meter, headphone style)**

Model 625 pygmy meter

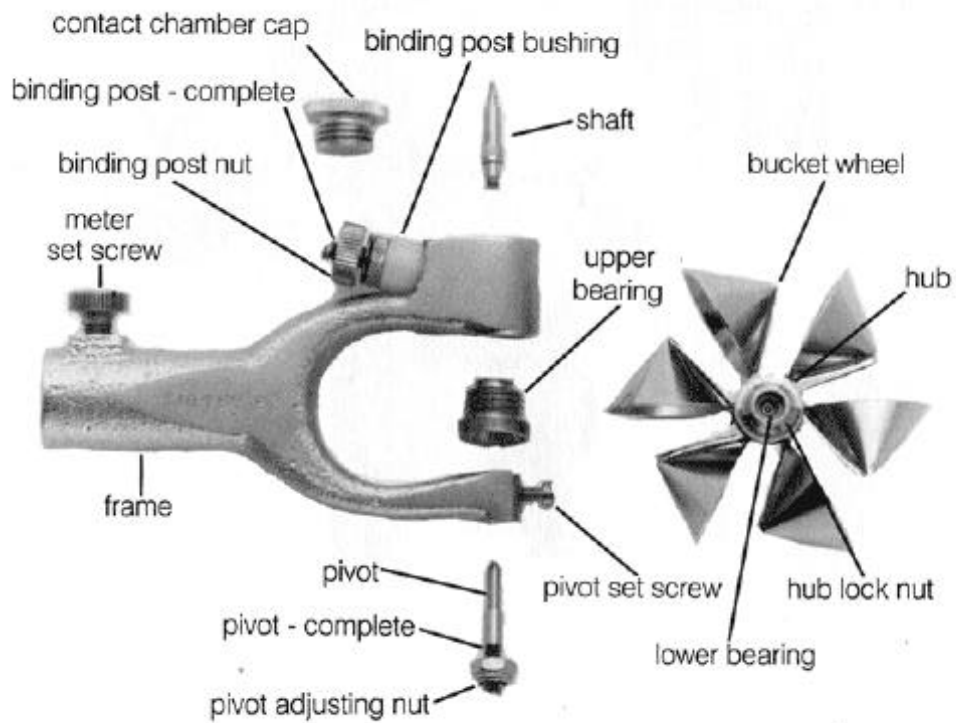
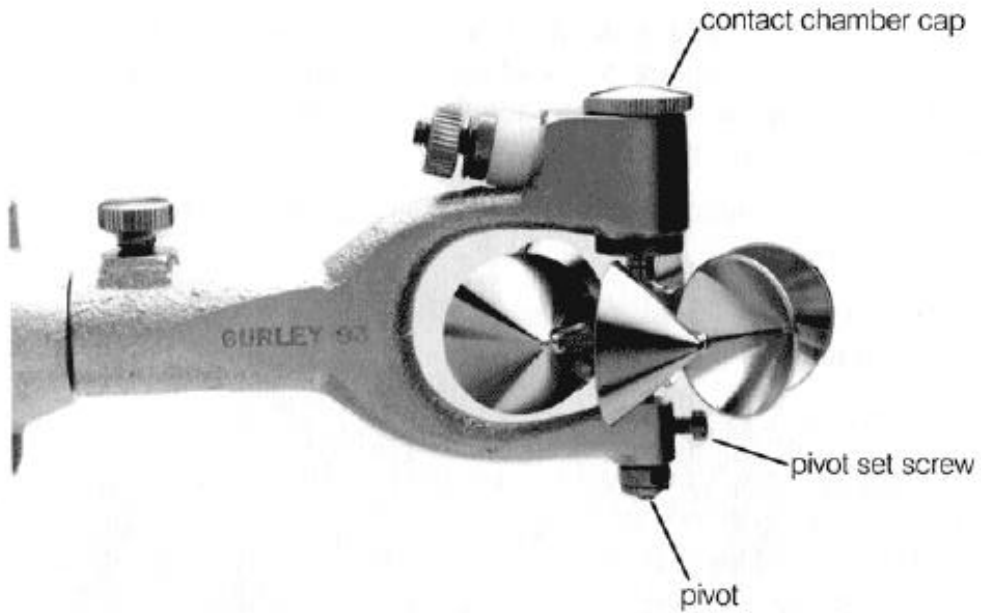

Pygmy meter

**1** Contact chamber cap

**2** Pivot Pivot

**3** Shaft

**4**

**5** Frame Bearing

**6** Hub lock nut Hub assembly

Hub, Bearing

6.6 Meter (D625 Pygmy meter, digital style)

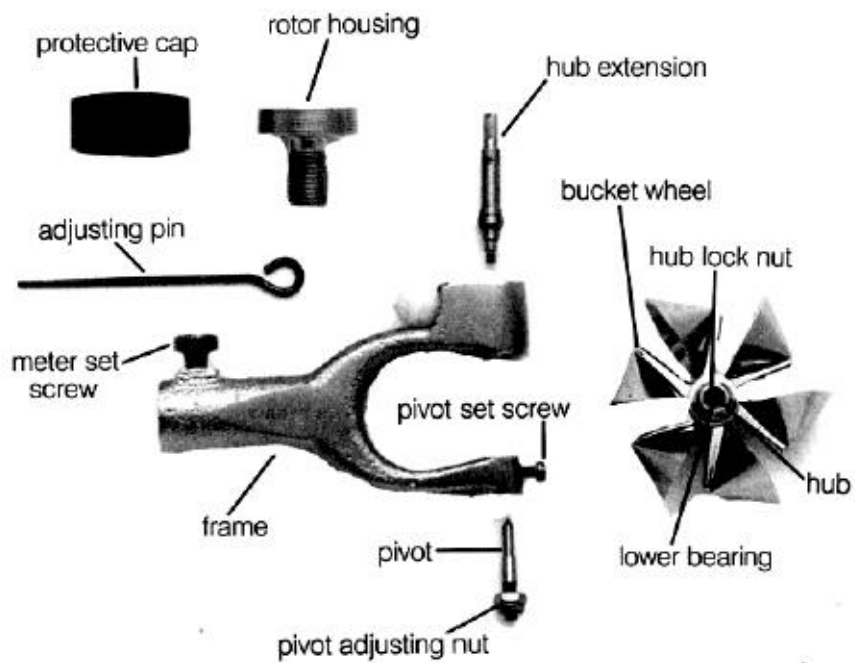
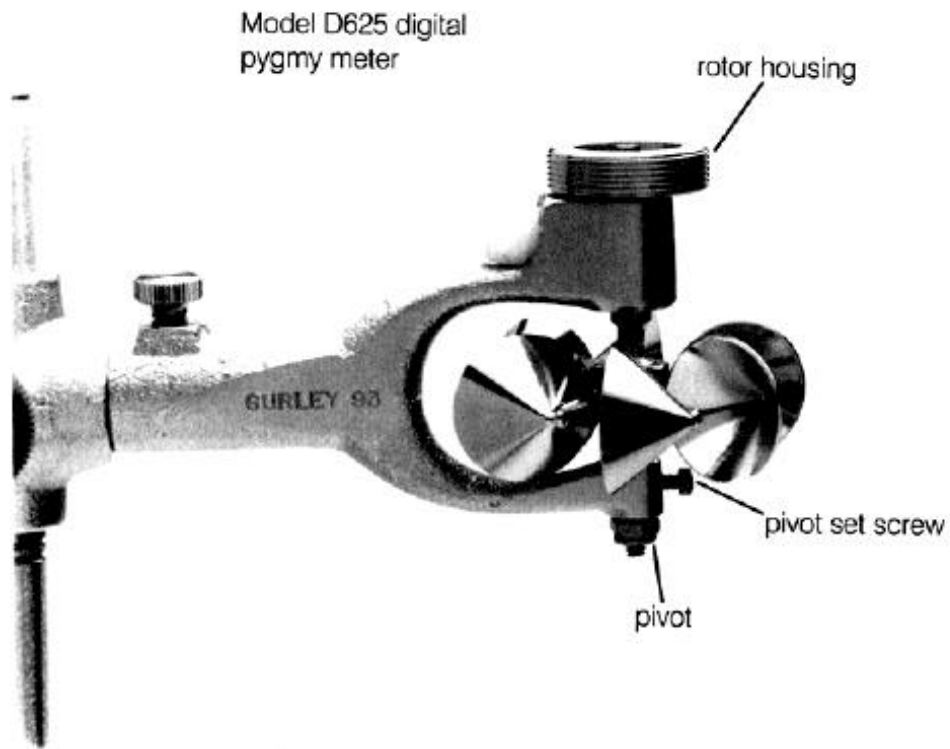

D625 Pygmy meter

**1** Protective cap Rotor housing

**2** Pivot Pivot

**3** hub extension

Adjusting pin

“ ”

hub extension

**6** Frame

**7** Hub Assembly Hub luck nut

**Hub bearing**



## 7. Headphones

### 7.1



# Part 4 – 1100

1100 Digital Flow Velocity Indicator

, Price & Pygmy Meter

3

37† , automatic, averaging, manual

## 8.1

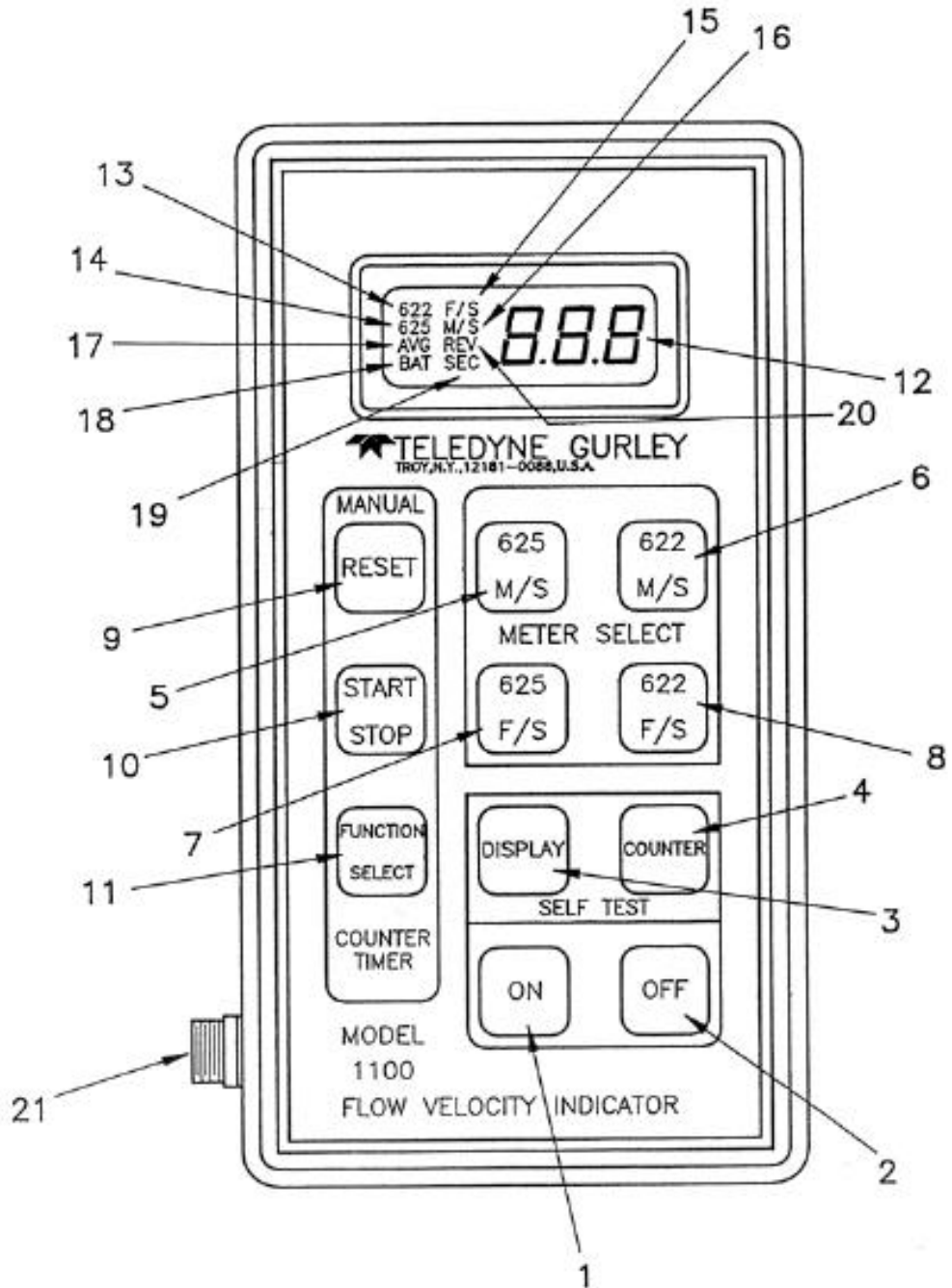

1 (ON)	ON
2 (OFF)	OFF
3 (DISPLAY)	가
4 (COUNTER)	가 , ( 가 가 ) .
5 (625 MS)	625 MS , 625 (meters per second) Automatic
6 (622 MS)	622 MS , 622 (meters per second) Automatic
7 (625 FS)	625 FS , 625 (feet per second) Automatic
8 (622 FS)	622 FS , 622 (feet per second) Automatic
9 (RESET)	(Reset) , , .
10 (START STOP)	Start/Stop , , .
11 (FUNCTION SELECT)	, .
12	(seconds, revolutions or velocity)
13	622 , 622 ,
14	625 , 625 ,
15	F/S ,
16	M/S ,
17	AVE ,
18	BAT , .
19	SEC , 가 ,
20	REV , 가 , Revolution
21	(622 price & 625 pygmy) .

## 8.2 가

- 1100 가 가 .
- 1) 1100 Meter(D622 or D625) .
  - 2) ON . 000 .
  - 3) 가 DISPLAY .  
: DISPLAY 가 가  
COUNTER .
- DISPLAY , 000 999  
BAT 3 .  
999 .
- 4) DISPLAY 가 , OFF , 가  
가 가 COUNTER .  
1 1 .
  - 5) .
  - 6) Counting mode 가 OFF .
  - 7) 1100 가 , .  
(9VDC) ,BAT 가 .



### 8.3.3

. 1100

1) Price D622 (Pygmy D625) 1100

2) ON

3) 가 RESET

4) Revolution START/STOP

\*

: Revolution FUNCTION SELECT

REV가 , Revolution 가

FUNCTION SELECT

5) , START/STOP

FUNCTION SELECT

6) RESET , 4) ~ 5)

## Part 6 – Repair Parts

+/-2%

<b>625 pygmy model (headphone)</b>	<b>0.05 ~ 33.0 fps / 0.02 ~ 0.9 mps</b>
<b>625 pygmy model (611 counter)</b>	<b>0.05 ~ 11.0 fps / 0.02 ~ 3.3 mps</b>
<b>D625 pygmy model (digital)</b>	<b>0.05 ~ 15.0 fps / 0.02 ~ 4.5 mps</b>
<b>622 Price model</b>	<b>0.02 ~ 25.0 fps / 0.06 ~ 7.6 mps</b>

611 Counter

Pygmy Meter

1100

15fps(4.5mps)

가

“ 4.5 ”

Price Meter

# Hydrological Equipment Genuine Gurley Precision Instruments



1 : 2003 4 1

.  
. .  
:

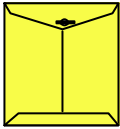

“Genuine Gurley Precision  
Instruments”



TEL : 332-7511 ( ), FAX : 332-5912 ( )

ID :

e-mail : [sechang@sechang.com](mailto:sechang@sechang.com)

Internet Website : <http://www.sechang.com>







**SECHANG INSTRUMENTS**