



ABB

The Company

We are an established world force in the design and manufacture of instrumentation for industrial process control, flow measurement, gas and liquid analysis and environmental applications.

As a part of ABB, a world leader in process automation technology, we offer customers application expertise, service and support worldwide.

We are committed to teamwork, high quality manufacturing, advanced technology and unrivalled service and support.

The quality, accuracy and performance of the Company's products result from over 100 years experience, combined with a continuous program of innovative design and development to incorporate the latest technology.

The NAMAS Calibration Laboratory No. 0255 is just one of the ten flow calibration plants operated by the Company, and is indicative of our dedication to quality and accuracy.

EN ISO 9001:1994



Cert. No. Q05907

EN 29001 (ISO 9001)



Lenno, Italy – Cert. No. 9/90A

Stonehouse, U.K.



Electrical Safety

This instrument complies with the requirements of CEI/IEC 61010-1:2001-2 'Safety Requirements for Electrical Equipment for Measurement, Control and Laboratory Use'. If the instrument is used in a manner NOT specified by the Company, the protection provided by the instrument may be impaired.

Symbols

One or more of the following symbols may appear on the instrument labelling:

	Warning – Refer to the manual for instructions
	Caution – Risk of electric shock
	Protective earth (ground) terminal
	Earth (ground) terminal

	Direct current supply only
	Alternating current supply only
	Both direct and alternating current supply
	The equipment is protected through double insulation

Information in this manual is intended only to assist our customers in the efficient operation of our equipment. Use of this manual for any other purpose is specifically prohibited and its contents are not to be reproduced in full or part without prior approval of the Technical Publications Department.

Health and Safety

To ensure that our products are safe and without risk to health, the following points must be noted:

1. The relevant sections of these instructions must be read carefully before proceeding.
2. Warning labels on containers and packages must be observed.
3. Installation, operation, maintenance and servicing must only be carried out by suitably trained personnel and in accordance with the information given.
4. Normal safety precautions must be taken to avoid the possibility of an accident occurring when operating in conditions of high pressure and/or temperature.
5. Chemicals must be stored away from heat, protected from temperature extremes and powders kept dry. Normal safe handling procedures must be used.
6. When disposing of chemicals ensure that no two chemicals are mixed.

Safety advice concerning the use of the equipment described in this manual or any relevant hazard data sheets (where applicable) may be obtained from the Company address on the back cover, together with servicing and spares information.

CONTENTS

Section	Page	Section	Page
1 INTRODUCTION	1	APPENDIX A	10
2 OPERATION	2	A1.1 Programming The Transmitter with a Data Terminal	10
2.1 Startup	2	A1.2 Using Personal Computers with MagMaster	10
3 CONFIGURING THE TRANSMITTER	2	A1.2.1 PC Tools	11
3.1 Filing Cabinet Analogy	2	A1.2.2 Windows 'TERMINAL'	11
3.2 Getting Started	3	A1.2.3 Odyssey and Procomm Plus	11
3.3 Looking at the Main Menu	4	A1.2.4 'VBC' and 'Aquamag'	11
3.4 Choosing a Main Menu Item	4	A1.3 Quick Set-up for Psion Series 3	11
3.5 The Main Menu	6	A1.4 Setup for Psion Organiser II (CM, XP, LZ, LZ64)	13
3.6 Password Access	6	A1.4.1 Keyboard Designations (Psion Organiser II)	13
3.6.1 Gaining Access to the User Level	6	APPENDIX B	14
3.6.2 Gaining Access to the Engineer Level	7	B1.1 Parameter Tree Structure	14
3.7 Changing the Value of a Parameter	7	B1.2 Description of Parameters	16
3.7.1 Numerical Value Parameters	7	APPENDIX C MAGMASTER SYSTEM DIAGRAM	23
3.7.2 Logic ('1' or '0') Value Parameters (Excluding Alarm Parameters)	8		
3.7.3 Alarm Parameters	9		
3.8 Advanced Techniques	9		
3.8.1 Fast Selection of Parameters	9		
3.8.2 Fast Selection plus Data Entry	9		

Trademarks: All Trademarks used in this manual are gratefully acknowledged.

SAFETY MEASURES

Warning.

- EXPLOSION HAZARD.
SUBSTITUTION OF COMPONENTS MAY IMPAIR SUITABILITY FOR CLASS I, DIVISION 2.
 - EXPLOSION HAZARD.
DO NOT REMOVE FUSE OR DISCONNECT POWER LEADS WHILE CIRCUIT IS LIVE.
 - THE LOCAL TERMINAL MUST NOT BE USED WHEN THERE IS AN EXPLOSION RISK.
-

Warning.

- Installation and maintenance must only be carried out by suitably trained personnel.
 - HAZARDOUS AREA DESIGNATION ON THE EQUIPMENT LABEL MUST BE SUITABLE FOR THE INTENDED DUTY AND LOCATION.
 - All relevant sections of this manual must be read before selecting a location.
 - Safety requirements of this equipment, any associated equipment, and the local environment must be taken into consideration.
 - The installation and use of this equipment must be in accordance with relevant national and local standards.
-

1 INTRODUCTION

This manual provides details to enable the MagMaster™ transmitter to be reconfigured from default parameters or from parameters initially set up by the factory to special order. This may be achieved via the communications link or a HART Terminal.

2 OPERATION

2.1 Startup

Switch on the power supply to the flowmeter and if a transmitter with display has been ordered, the flow rate will be shown on the bottom line of the display as shown below.

Sequential application of the provided magnetic wand to the left hand icon in the transmitter display area steps the top line display through the following sequence:

%	(Flow Rate % of Range)
>	(Forward flow total value)
<	(Reverse flow total value)
*	(Net flow total value)
Alm	(Active alarms)
Vel	(Flow Velocity in m/s or ft/s)

Any alarms are displayed sequentially if more than one alarm is present.

The second display line normally indicates flow rate in chosen units, but alternates with an alarm indication signal (Alm) if any alarms occur – see **Fault Finding** book.

Application of the wand to the right hand icon resets the totaliser display if reset is enabled (see Para 3.7, Parameter 73).

To gain access to the above information when a transmitter without display has been ordered, proceed as detailed in the following pages.

3 CONFIGURING THE TRANSMITTER

3.1 Filing Cabinet Analogy

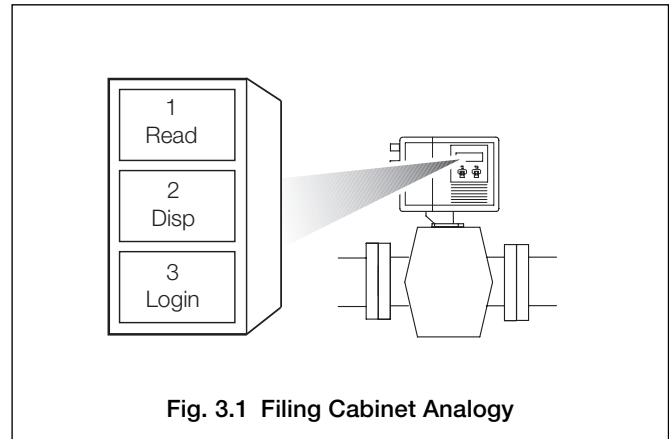

Fig. 3.1 Filing Cabinet Analogy

The main menu is accessed similarly to opening the drawers of a filing cabinet, each drawer of the cabinet representing an item of the main menu.

Main Menu items 1 to 3 are generally accessible; the remainder are password protected.

Files in the drawers of the cabinet would represent the groups of parameters provided by the transmitter which, if required, may be viewed or changed as shown in this, and the following pages.

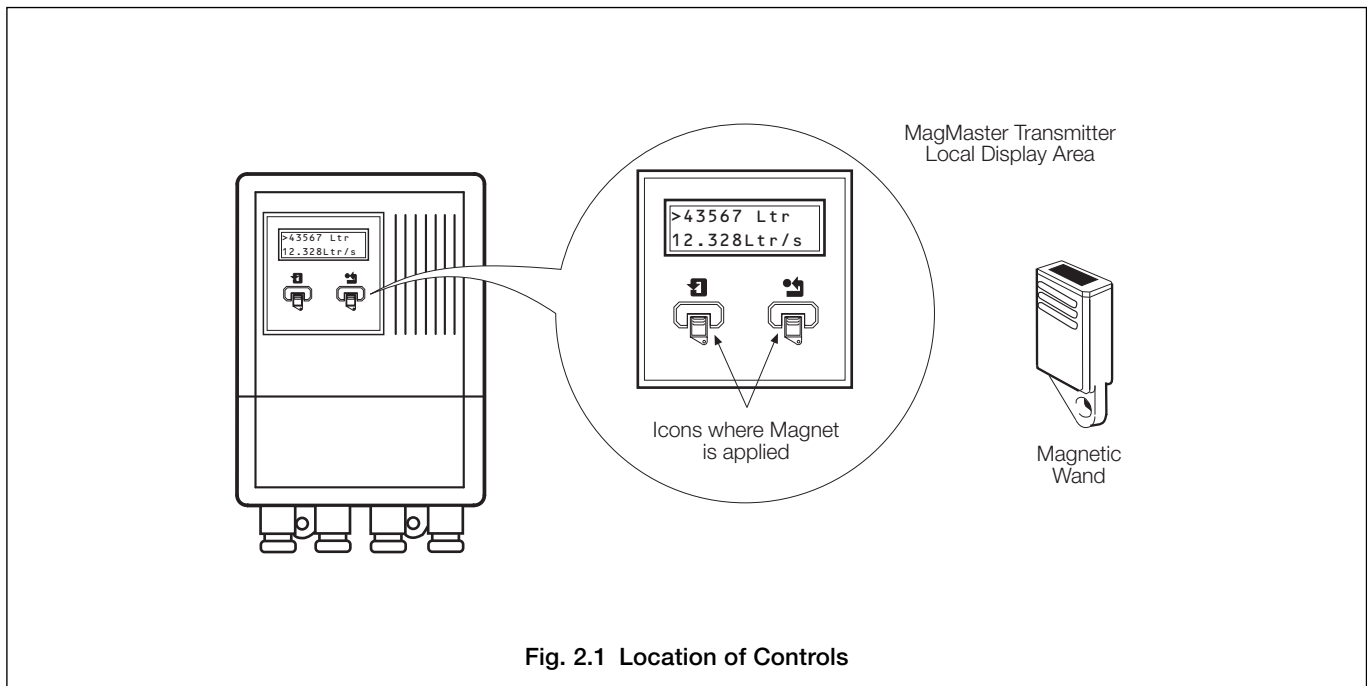

Fig. 2.1 Location of Controls

3.2 Getting Started

The Transmitter is delivered set up either with your chosen units, or set with our standard default values.

Warning. Ensure Plant Safety at all times while configuring.

If you need to change the transmitter configuration for any reason, this may be done by connecting a terminal device e.g. Personal Computer, Electronic Organiser etc., to the transmitter via the 9-way D-Type connector, found by sliding the movable section of the transmitter cover in the direction of the cable glands.

Note. There is no 9-way D-Type connector available on the Hygienic version transmitter; cable must be hard-wired from inside the transmitter via the cable glands.

Special software is not required for configuring the transmitter; any communication program will suffice.

Connect the programming terminal to the transmitter (See APPENDIX A for details of connection and setup of data terminals etc. to the transmitter).

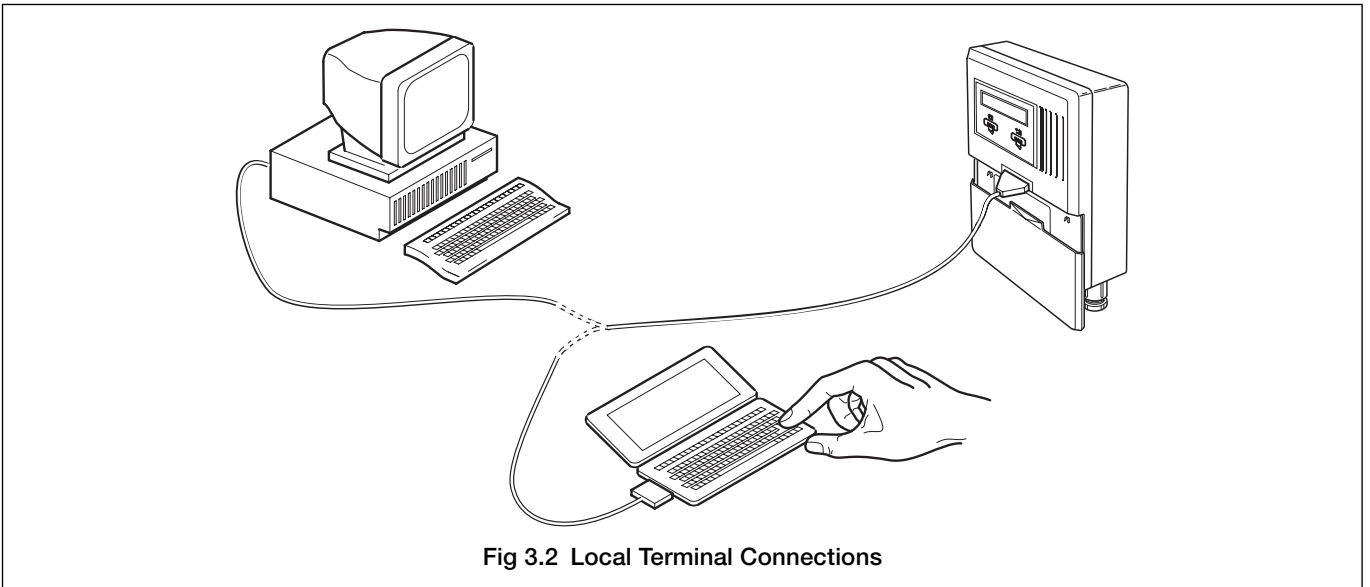
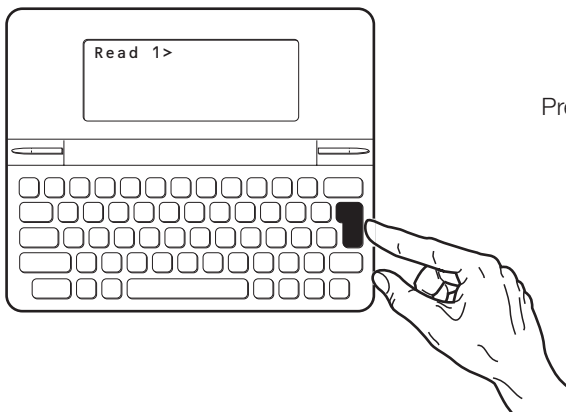
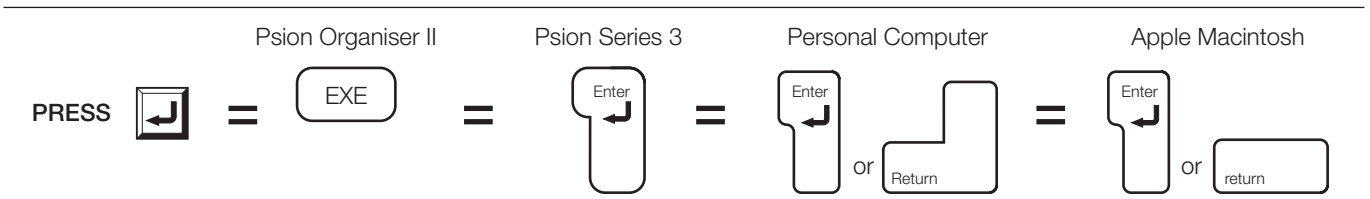



Fig 3.2 Local Terminal Connections

With connections made and the power switched onto the transmitter and terminal, proceed as shown below:



Press  until display shows first item on main menu
i.e. 'Read 1>'

...3 CONFIGURING THE TRANSMITTER

3.3 Looking at the Main Menu

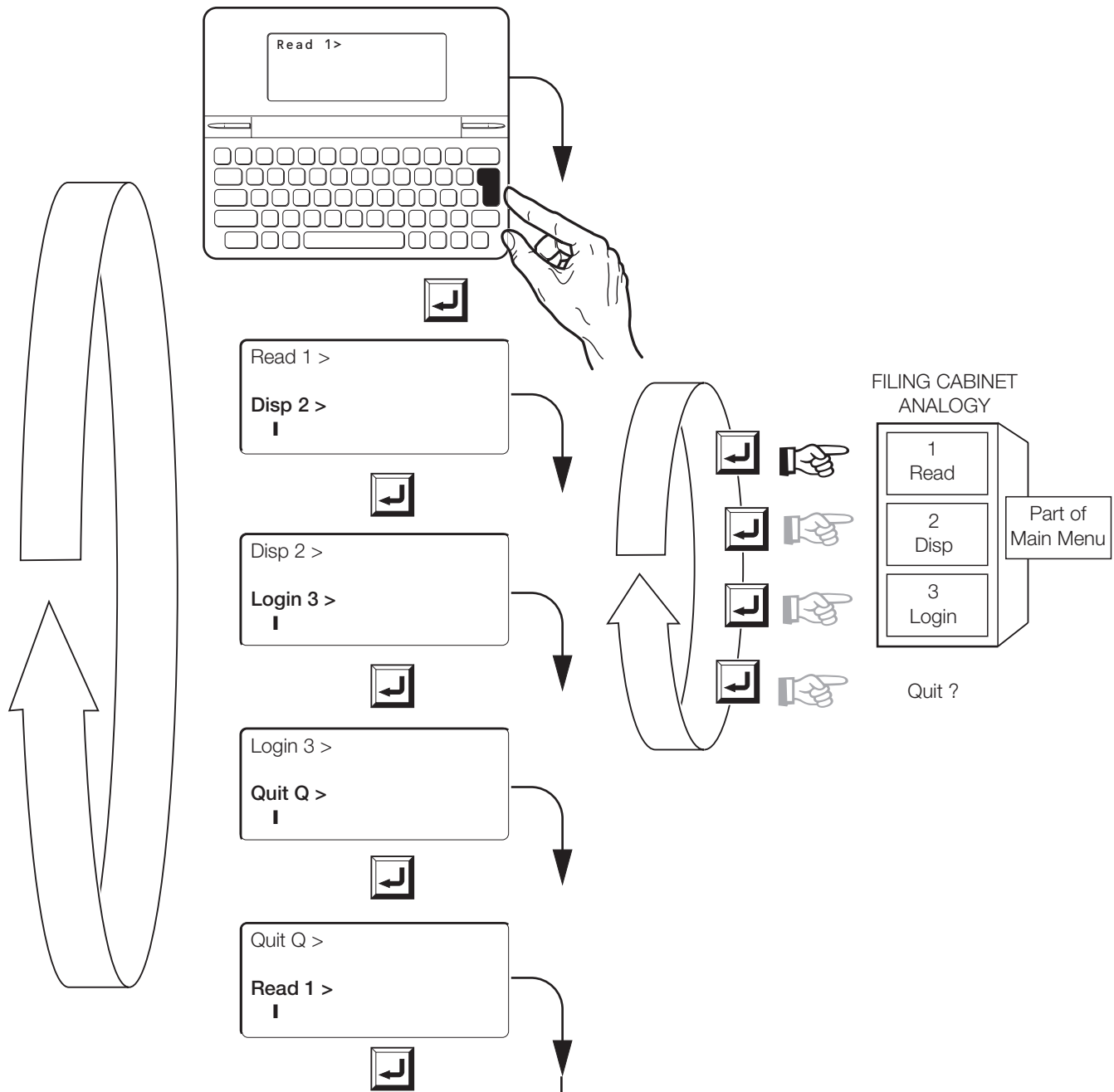

3.4 Choosing a Main Menu Item

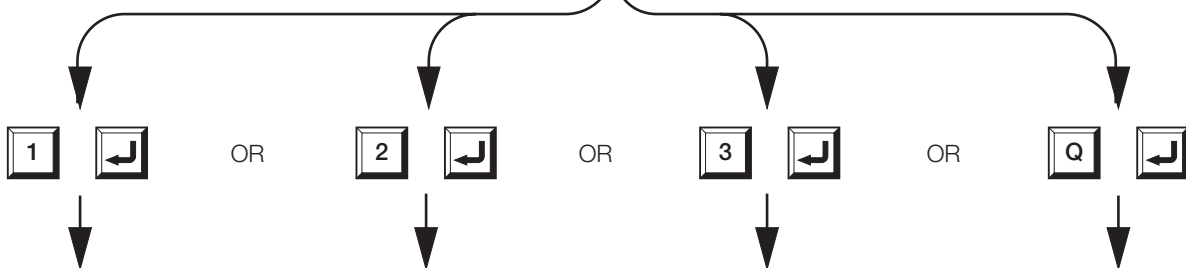

3 CONFIGURING THE TRANSMITTER...

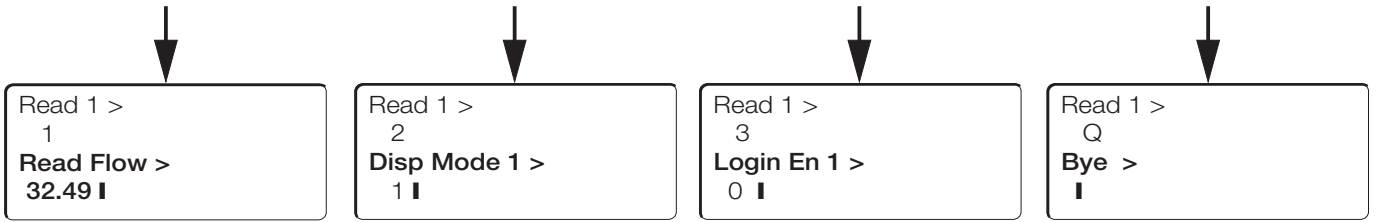

'Read Flow' (Item 1 of 'Read' menu) opened and parameter value displayed.

'Disp Mode' (Item 1 of 'Disp' menu) opened and parameter value displayed.

'Login En' (Item 1 of 'Login' menu) opened and parameter value displayed.

'Quit'

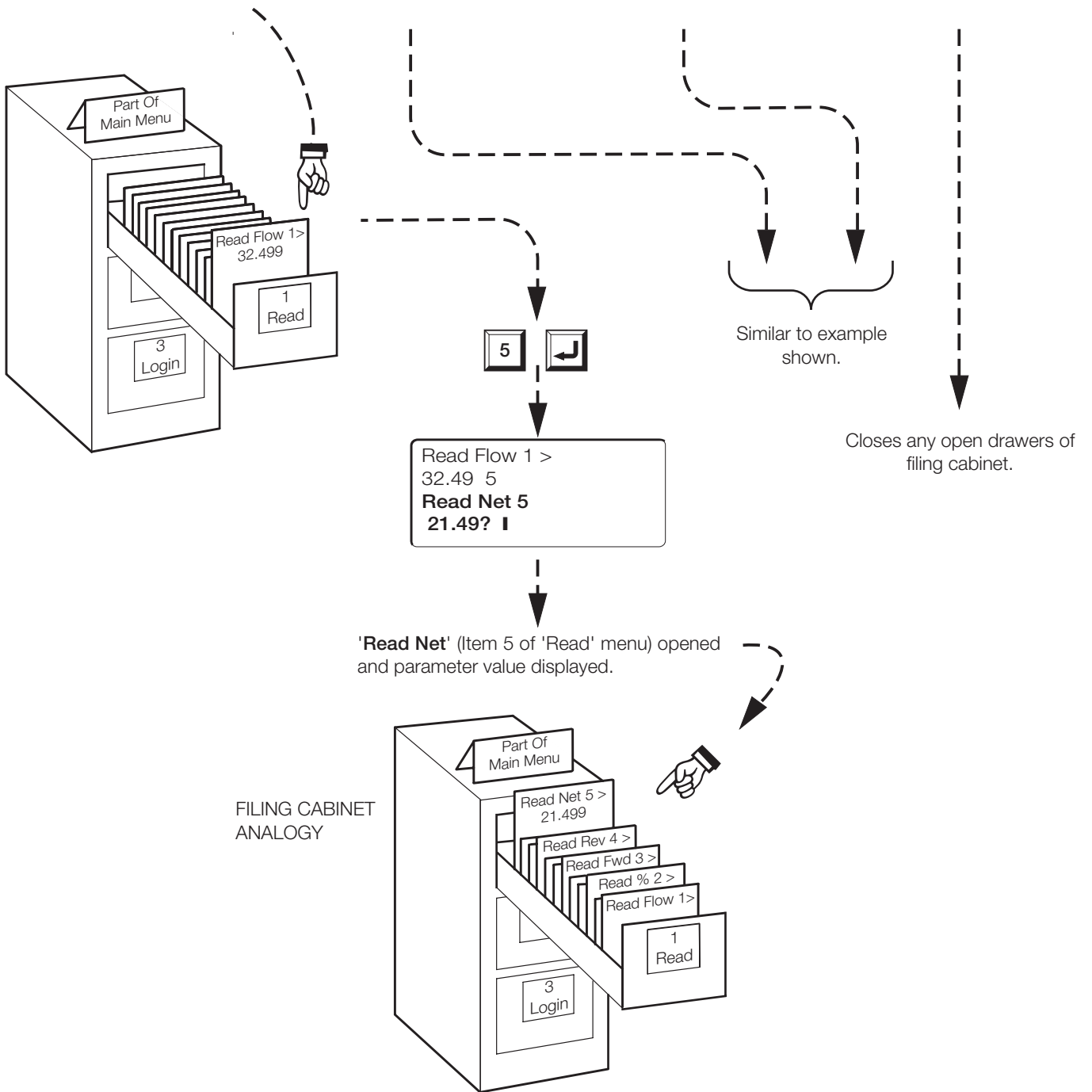

...3 CONFIGURING THE TRANSMITTER

3.5 The Main Menu

SECURITY ACCESS

No security password required
(Level '0')

User security password required
(Level '1')

Engineer security password required
(Level '2')

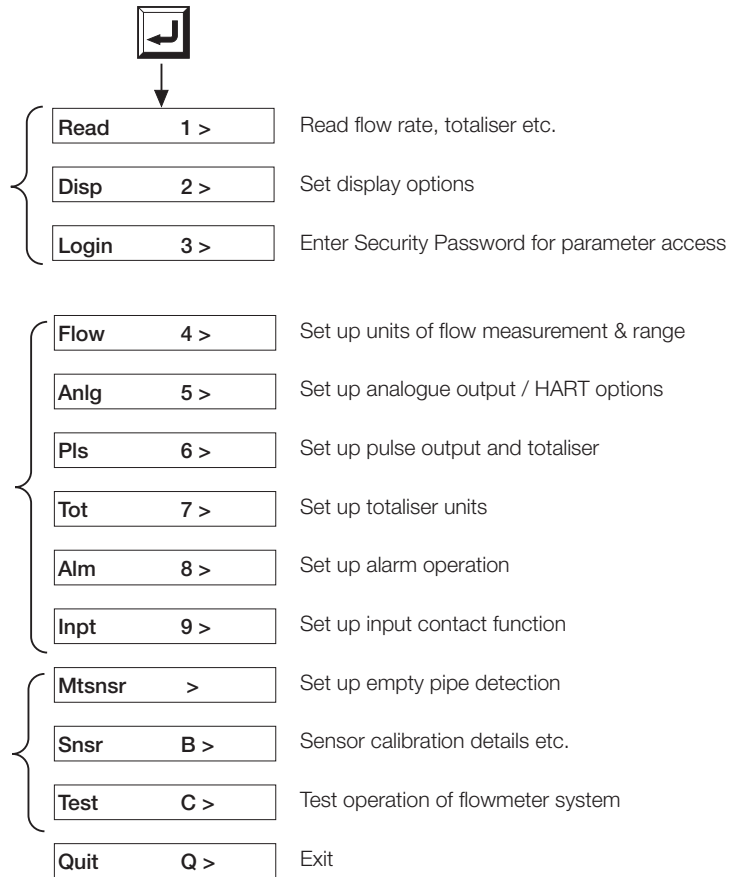
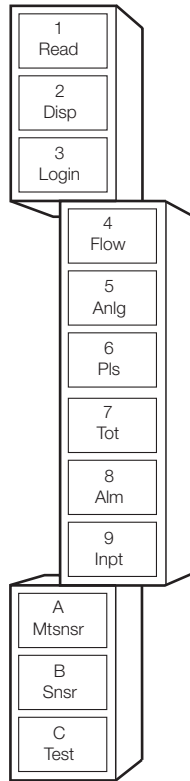

3.6 Password Access

3.6.1 Gaining Access to the User Level

Note. The passwords shown below ('user' and 'engineer') are the factory default settings: you can change these for increased security, if required.

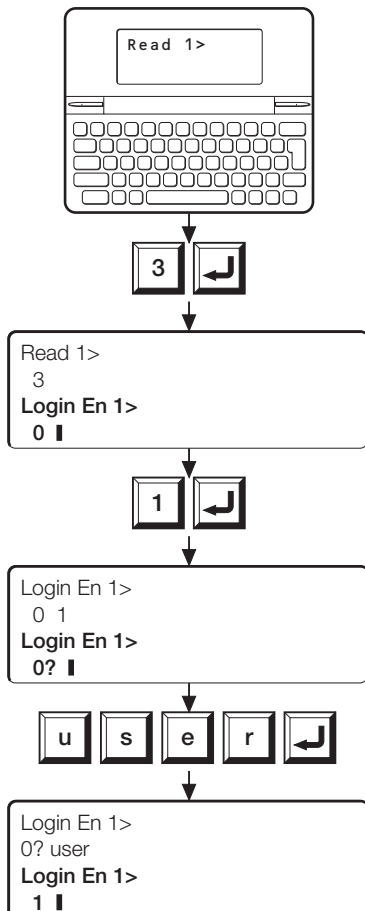

From '3.1 Getting Started'

Entering '3' accesses 'Login' item from Main Menu.

Entering '1' accesses Login Enable parameter.

'?' shows that you can change the '0' security level value.

Entering password 'user' accesses level 1 security level. Note the use of lower case in this example. All passwords are case sensitive.

'1' indicates security access level 1 is now in operation.

3.6.2 Gaining Access to the Engineer Level

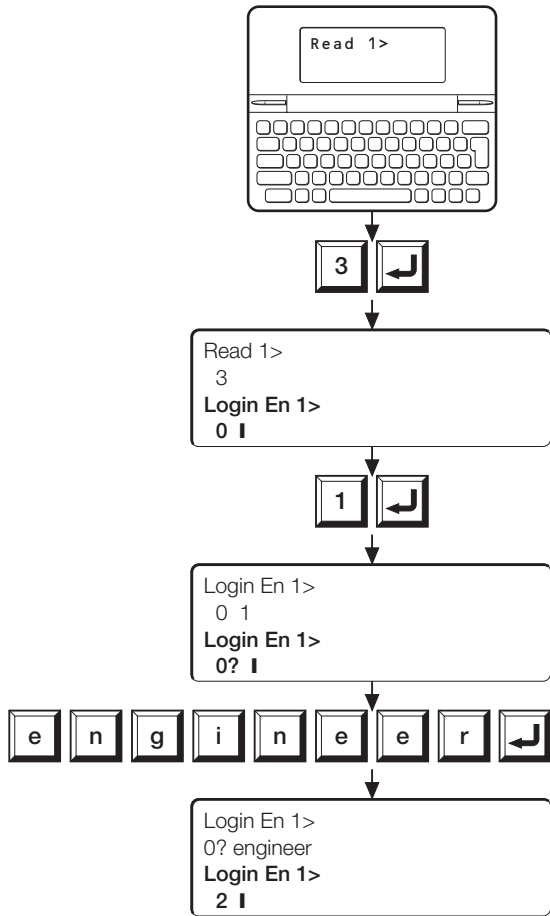

From '3.1 Getting Started'.

Entering '3' accesses 'Login' item from Main Menu.

'0' indicates security access level 0 is in operation.

Entering '1' accesses Login Enable parameter.

'?' shows that you can change the '0' level value.

Entering password 'engineer' accesses level 2 security level. Note the use of lower case in this example. All passwords are case sensitive.

'2' indicates security access level 2 is in operation.

3.7 Changing the Value of a Parameter

3.7.1 Numerical Value Parameters

Note. Many parameters, e.g. the flowrate, are calculated internally and the new value entered will therefore be ignored.

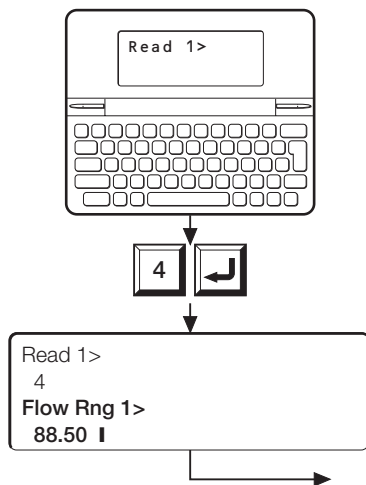

From 3.5.1 or 3.5.2, after gaining 'user' or 'engineer' access.

Entering '4' accesses Flow sub-menu from Main Menu: Item 1 (Flow Range) displayed.

'88.50' indicates present 100% Flow Range or 'Upper Range Value' ('URV')

...3 CONFIGURING THE TRANSMITTER

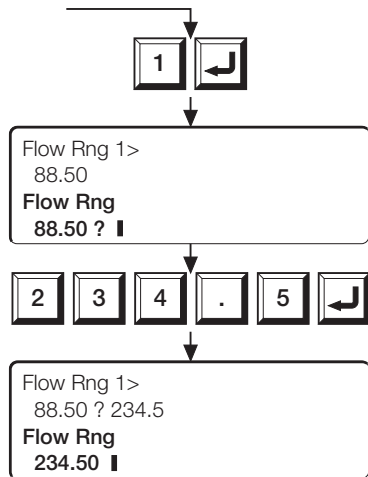

Entering '1' selects this parameter.

'?' shows that you can change this value.

Enter a new value of % Flow Range.

New range setting of 234.5 now in use.

Note. When a '?' prompt is showing, press to leave current value unaltered.

3.7.2 Logic ('1' or '0') Value Parameters (Excluding Alarm Parameters)

Note. Flow units are mutually exclusive in that only one unit can be selected at any one time. All other units are automatically deselected.

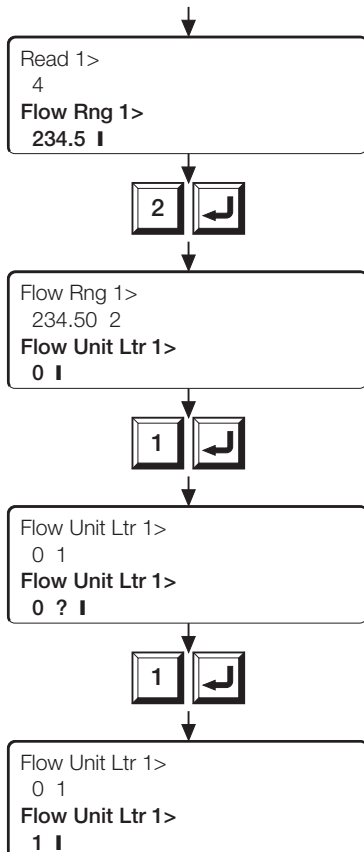

Entering '4' as above in 3.7.1 accesses Flow sub-menu.

Entering '2' accesses item 2 (Flow Units) of the Flow sub-menu.

'0' shows that this Flow Unit parameter (Litres) is not selected.
1 = Unit selected; 0 = Unit not selected.

Entering '1' accesses Flow Unit Ltr parameter 1 .

'?' shows that you can change this logic '0' value.

Entering '1' selects this 'units' parameter.
(All other parameters in the Flow Unit sub-menu automatically change to '0').

'1' indicates that litre flow units have been selected.

3.7.3 Alarm Parameters

Note. Alarm Parameters are selected with a '1' and deselected with a '0' as shown in the previous flow unit types, but any combination of Alarm Parameters may be selected or deselected as required. Automatic deselection of parameters not required does not take place with alarm parameters.

3.8 Advanced Techniques

3.8.1 Fast Selection of Parameters

Refer to the B1.1 Parameter Tree Structure diagram.

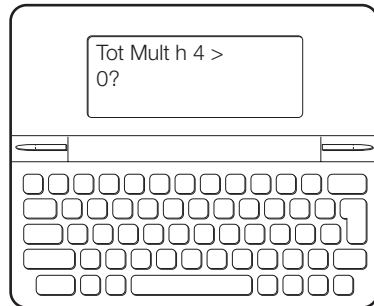

To select 'Flow Unit IGal' from **any parameter** (e.g. Tot Mult h):

Pressing the ESCAPE key resets the prompt to the START position. 4 2 3 routes the prompt through the required menus to the Flow Unit Menu.

'0' indicates that the gallon units are not selected.

? indicates that it is possible to change the value to a '1' if required.

Any route through the tree structure can be similarly processed if the associated numbers and/or letters for the route is known.

e.g. ESC 8 3 1 followed by ENTER will allow the High Alarm Trip Level to be altered.

3.8.2 Fast Selection Plus Data Entry

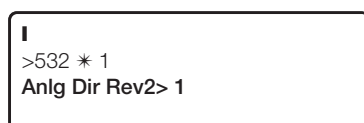
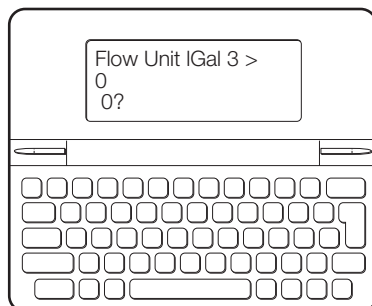

To select '**Reverse Analogue Direction** parameter'

Pressing the ESCAPE key resets the prompt to the START position.

5 3 2 routes the prompt through the required menus to the **Reverse Analogue Direction** parameter.

* simulates the ENTER key without terminating the sequence, which would occur if the normal ENTER key were used.

'1' is entered to select the parameter.

Note. Any other necessary data can be entered at this point; e.g. with the correct routing, a password could be entered (31* user).

The enter key completes the command.

APPENDIX A

A1.1 Programming The Transmitter with a Data Terminal

The nine-pin transmitter front panel connector is compatible with most serial devices, e.g. PSION Organiser, IBM PC, using proprietary adaptors where required. This connection is for 'local' use only, i.e. for up to approximately 5 metres between transmitter and data terminal.

The optional RS422/423 interface may be used for considerably greater distances (see **Installation Manual** for connections).

Most serial data terminals may be connected to the transmitter providing that the following three requirements are met:

1. The data rate (transmit and receive) is 4800 Baud.
2. The data format is:

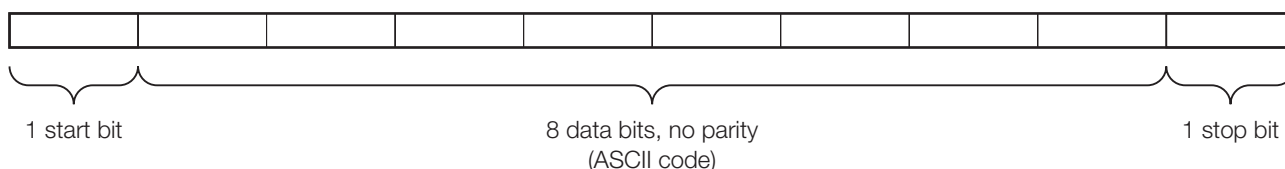

3. Format for computer entry is as above plus the control codes to alter response are typically as follows:

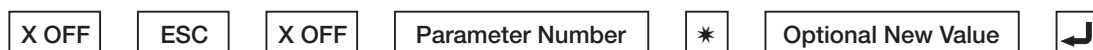

Where 'X OFF' suppresses character echo and the reply consists of the value only.

'ESC' forces the parameter number to start from the top of the Menu Tree.

'*' Separates the Parameter Number from the New Value.

N.B. If no value is entered before pressing ENTER, RETURN etc, the current value is retained.

X ON and/or ENTER will cancel the X OFF control.

Consult the Handbook for your particular terminal device.

A1.2 Using Personal Computers with MagMaster

Many communications software packages are available and in use, and can be used to interface with the MagMaster™.

The following is a sample of typical communications programmes and setup details for interfacing with the MagMaster™.

A personal computer can be used to communicate with MagMaster to set up its operating parameters. The only requirements are:

- 1) The computer can be any make or type (eg. Apple, BBC, Atari, Amiga, PC etc.) but it must be equipped with a serial communications port capable of operation at 4800 baud. (RS232C is the most common type). Most computers are fitted with this as standard. It is not possible to give specific instructions for all types of computer, because of the large number of computers available, but reference to the instructions of the machine to be used will provide the necessary information. A "dumb terminal", usually found connected to a mainframe computer, can also be used for configuring MagMaster.
- 2) The computer must be equipped with Terminal emulation software. In many machines (for example the BBC computer) this is built in, in others (IBM PC and AT for example) this has to be added. The software is not special in any way and there are many programmes on the market which provide or include this function, all of which are suitable for MagMaster use. Typical examples for the IBM PC/AT are:

Central Point's PC Tools	(Desktop Telecommunications)
Microsoft Windows	(Built in Terminal Emulator)
Odyssey	(Shareware programme)
Procomm Plus	(Shareware programme)
VBC.EXE	(ABB)
AQUAMAG.EXE	(VBC.EXE upgrade)

In all cases the Comms port parameters need to be set up as below; this function is normally provided as part of the software package being used.

Settings

Baud rate	4800
Data bits	8
Stop bits	1
Parity	NONE
Handshaking	NONE (OR RTS/CTS)
COMMS PORT	As appropriate (COM1, COM2 etc.)

Interconnection details

9-pin to 9-pin		9-pin to 25-pin	
2	3	2	2
3	2	3	3
4	6	4	6
5	5	5	7
6	4	6	20
7	8	7	5
8	7	8	4

The most common reason for lack of communication between a MagMaster and a computer or terminal, assuming that everything is set up as above, is the interconnecting lead. The correct lead to use is a LAPLINK lead, also known as a NULL MODEM. This is a lead which is designed to connect the communication ports of two computers together, and therefore the internal wiring "crosses over" (see **Interconnection Details** above). A serial printer lead will therefore not be suitable.

However, where the incorrect lead has been fitted, correct operation will normally result if the wires on pins 2 and 3 of one of the connectors are swapped over. **N.B.** A suitable lead (which also permits operation with certain Toshiba Laptop PCs) is available from ABB – see Book 6 Spares and Accessories.

A1.2.1 PC Tools

From the 'Desktop: Telecommunications' utility, use 'Edit: Create new entry' to enter the serial settings as required above and use 'Modem: Setup' to select the COMMS Port.

Use F8 or select 'Manual' to run the utility as a terminal emulator. Press ALT and ESC together once (the MENU bar will show 'ALT-ESC On'). This will allow the ESC key to be used with MagMaster.

A1.2.2 Windows 'TERMINAL'

Use 'Settings : Communications' to set up terminal settings as above.

Note. Avoid using the backspace key for editing, as this produces misleading results with the Windows Terminal display. Use the Delete key instead for this function.

A1.2.3 Odyssey and Procomm Plus

Use the Port and Setup menus to configure the settings as above.

A1.2.4 'VBC' and 'Aquamag'

These two programmes are very similar and provide a basic, but totally adequate, communication facility for MagMaster. The programmes are configured ready to use with COM1. They will also terminate if the serial port is not connected.

A1.3 Quick Set-up for Psion Series 3

The following instructions are a quick guide to setting up a Psion Series-3 for use with a MagMaster. Refer to the Psion Series-3 Instruction Manuals for full information. These steps are only necessary the first time that the Series 3 is used. If your Psion Series 3 was supplied by ABB, the Comms. Application will have been installed. Locate 'MagMastr' under the COMMS icon and press ; otherwise proceed as follows:

...APPENDIX A

- 1) Fit batteries to Organiser as described in Series 3 User guide page 3. Note ERRATUM sheet, if any, packed with unit.
- 2) Use the **Esc** key to turn it on and then use **↑** and **↓** keys, followed by **Enter** to select the language required (most models have this facility).
- 3) There may be a warning that the Backup battery is low, if so this can be ignored at this stage. (a new backup battery should be fitted later – see manual). If this happens press the **Esc** key.
- 4) To ensure sufficient memory is available (128k Model), close down the applications 'Data', 'Word', 'World', 'Calc' and 'Agenda' as follows:

Move the highlight block with **←** or **→** to application, press **Delete**, followed by **Y**.

Switch off by holding down **⏻** and **1** together.

- 5) Assemble the Psion 3-link cable as described in the 3-link manual page 2 onwards and plug it into the connector on the left side of the Series 3.
- 6) Press **Esc** to switch on again, this will give the system screen, showing the applications available. Press the Menu key, and use the **←** and **→** keys to select the "Apps" menu (the centre menu). Select "Install application" by using the **↑** and **↓** keys then press **Enter**.

Short cut: from the system screen, hold down **⏻** and press **1**.

- 7) Press **↓** key to select disk and then **←** and **→** to select "C". The top line should now show "Comms.app". If so press **Enter**. (If not press the **↑** and then use the **←** and **→** keys to select it, then press **Enter**). A new icon will appear, a picture of the organiser connected to a computer.
- 8) If necessary, use the cursor keys to highlight "Comms[C]" and press **Enter** to run the communications application. One of two possibilities will occur:
 - a) The screen will blank briefly and then a box containing a flashing cursor will appear, together with a message "Online..." Proceed to step 9.
 - b) A message "No system memory" appears. See step 4 above.

Move the highlight back to "Comms[C]" and repeat step 8.

- 9) Hold down **⏻** and press **J**. Use the cursor (**←** **→** **↓** and **↑**) keys to make Serial Port settings as below:

Set Serial Port

* Baud rate	4800
* Data bits	8
* Stop bits	1
* Parity	none
* Ignore parity	yes

Press **Enter** when finished.

- 10) Hold down **⏻** and press **K** to set up handshakes as below.

Set Serial Handshake

* Xon/Xoff	off
* Rts/Cts	off
* Dsr/Dtr	off
* Dcd	off

- 11) Press the **⏻** and **O** keys, followed by **↓**, **←**, **→** to select drive 'Internal' and then press **↑**.

Type in a suitable name, eg. 'MagMastr' (8 characters max.) and press **Enter**, to save the settings for future use.

The Series 3 is now ready for use with the MagMaster transmitter, as described in this Configuration Manual.

A1.4 Setup for Psion Organiser II (CM, XP, LZ, LZ64)

Note. It is recommended that the mains adapter is used to power the 'Organiser' where possible.

1. Connect the Psion Organiser Communications Link Adapter to the MagMaster Transmitter using a suitable adapter lead consisting of a 25-pin D-Type plug to 9-pin D-Type socket (available as a Psion accessory).
2. Scroll through the following list of items which will be shown on the 'screen' in the Comms 'SETUP' mode.

BAUD	4800
PARITY	NONE
BITS	8
STOP	1
HAND	NONE
PROTOCOL	NONE
ECHO	HOST
WIDTH	NONE
TIMEOUT	NONE
REOL	<CR><LF>
REOF	NONE
RTRN	NONE
TEOL	<CR>
TEOF	NONE
TTRN	NONE





Enter the following numbers to give the operations shown in the above:



13,10	<CR><LF>
13	<CR>

Select 'TERM' from the 'Comms' menu to allow communication with the MagMaster Transmitter.
Set COMMS to 'No Handshaking', 'No translations'.

Set the MagMaster Display Mode (Parameter '21') to '1'. (Refer to **3.6 Changing the Value of a Parameter** in this manual).

A1.4.1 Keyboard Designations (Psion Organiser II)

Function	Key
	
DEL	
ESC	 + 

Note. The  and  keys cannot be used, as these enable and disable the Organiser data output. Consult the Psion Organiser handbook for further information.

APPENDIX B

B1.1 Parameter Tree Structure

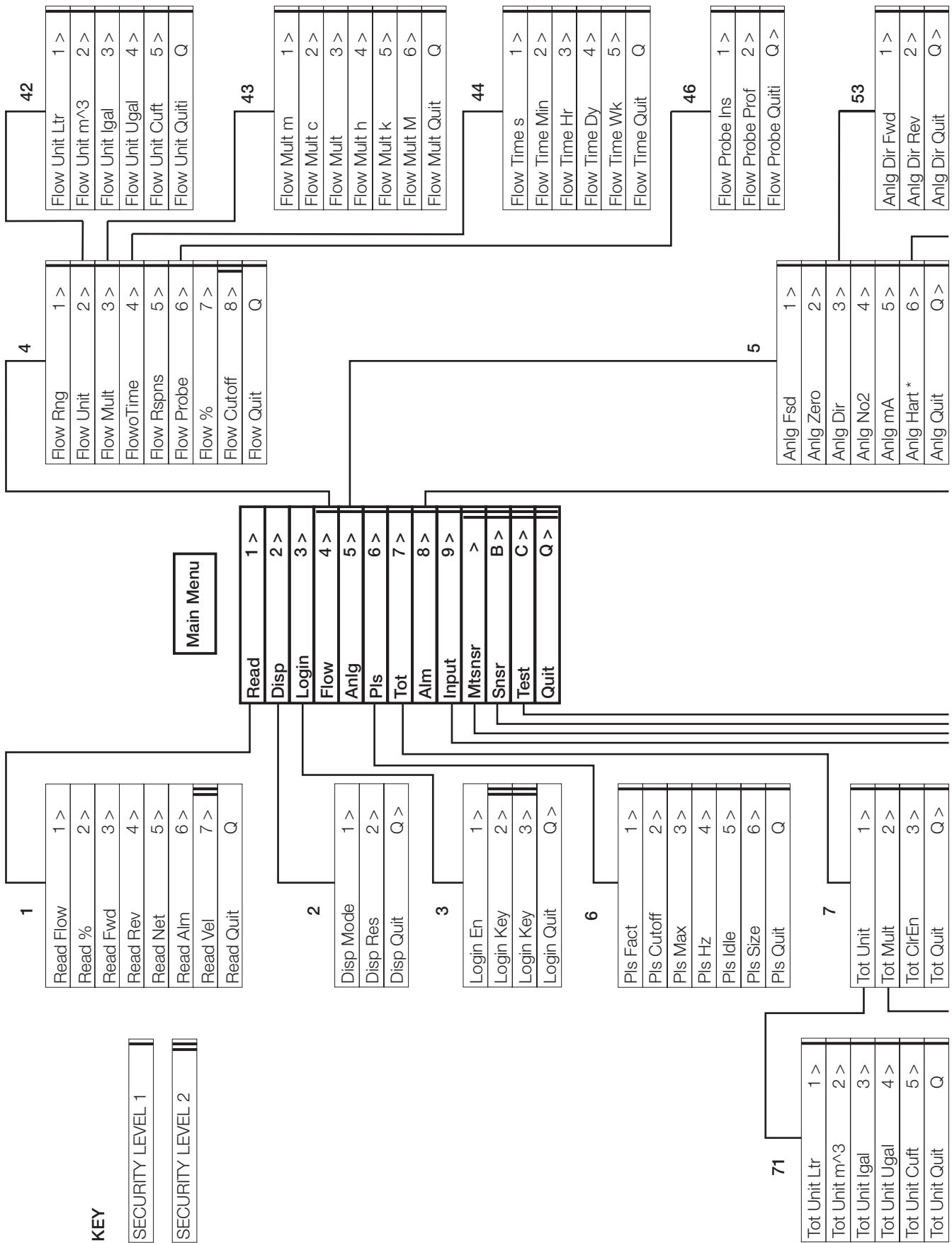

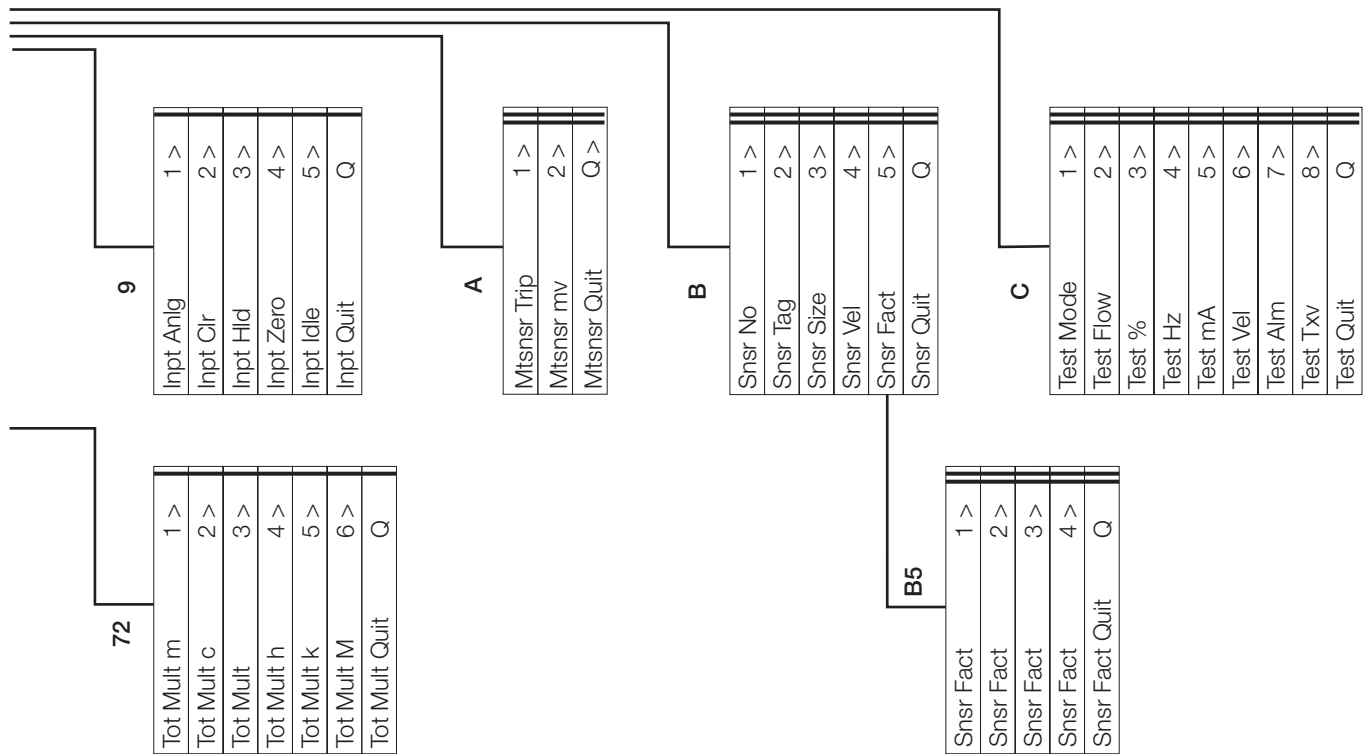
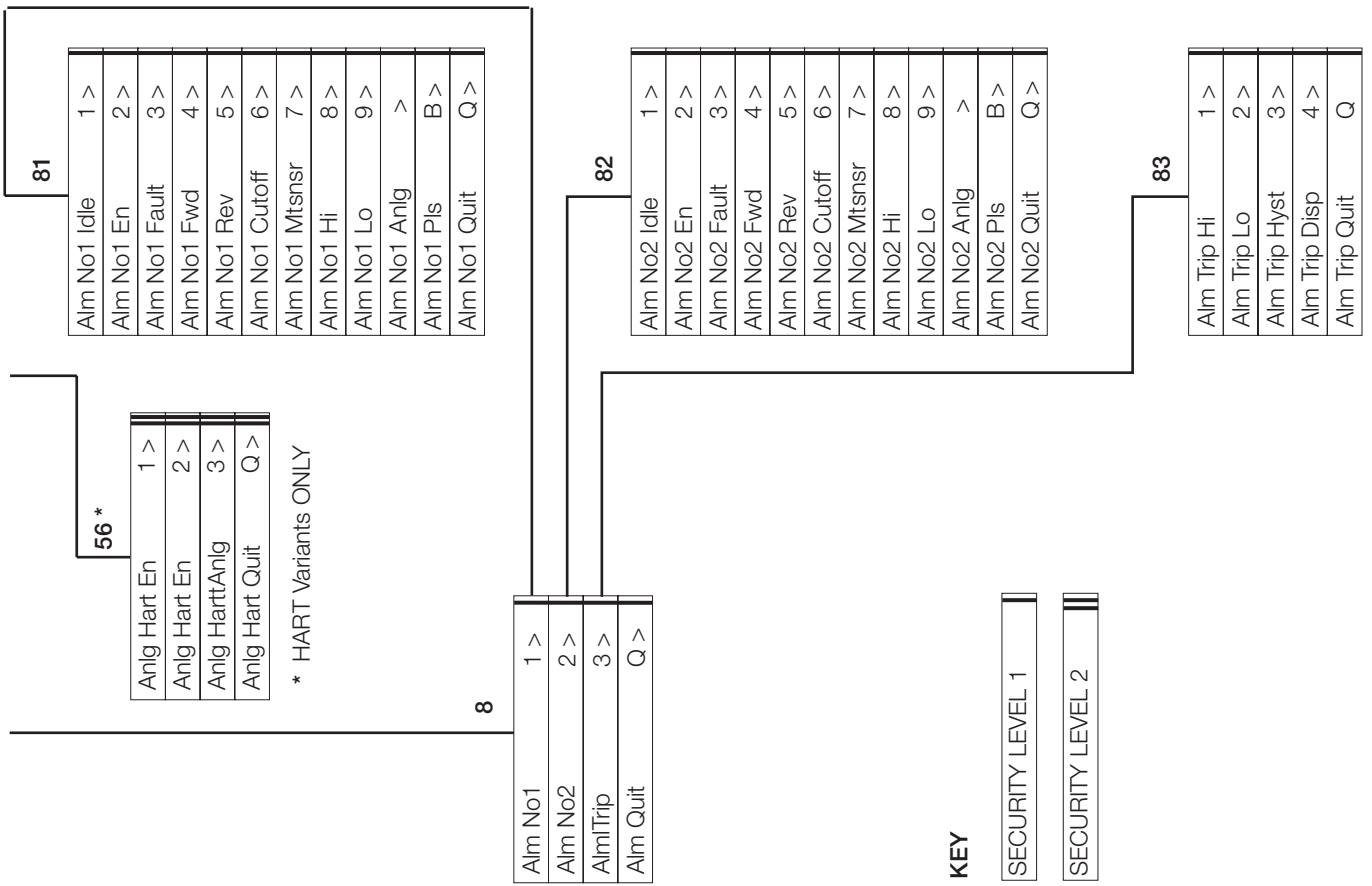

...APPENDIX B

B1.2 Description of Parameters

Select the access number or letter, of any of the items in the Main Menu, followed by a CR (RETURN etc), to access its associated sub-menu. It is not necessary for the parameter to be displayed to select it by number.

Note. The correct security level must be selected in **Login** parameter below to access certain parameters. See headings in this description or access notes against individual parameters.

Select the access number or letter of any item in a sub-menu, followed by a CR, to read the value or to change it as necessary. (CR)s without an access code cycles through a menu continuously without accessing a parameter. All 'live' data displayed is updated each second.

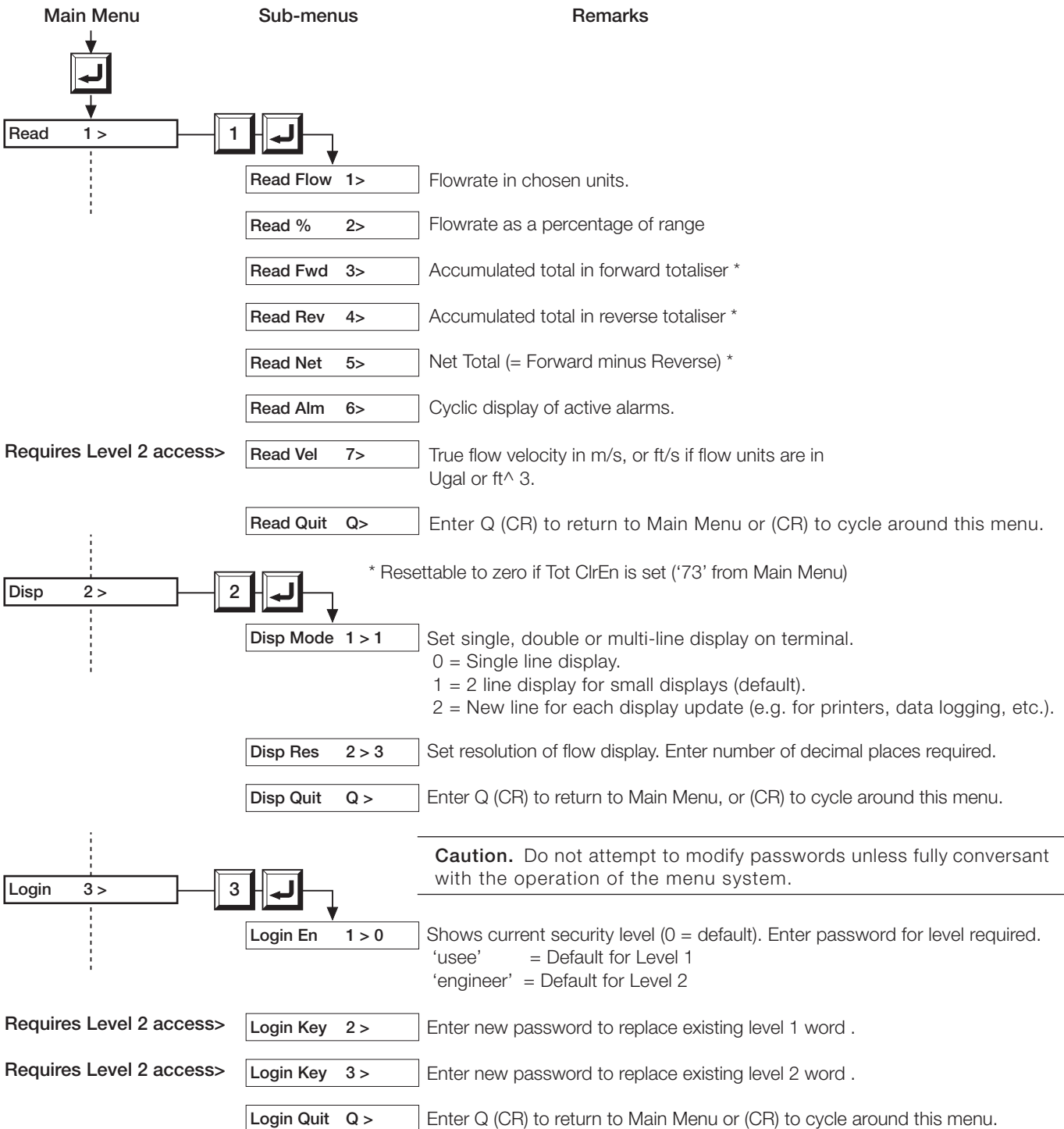

Note. Access level selected is reset to Level 0 after a 'Quit' from Main Menu.

Information. THE FOLLOWING PARAMETERS REQUIRE 'LEVEL 1' OR 'LEVEL 2' ACCESS.
(Enter passwords in 'Login En' parameter above).

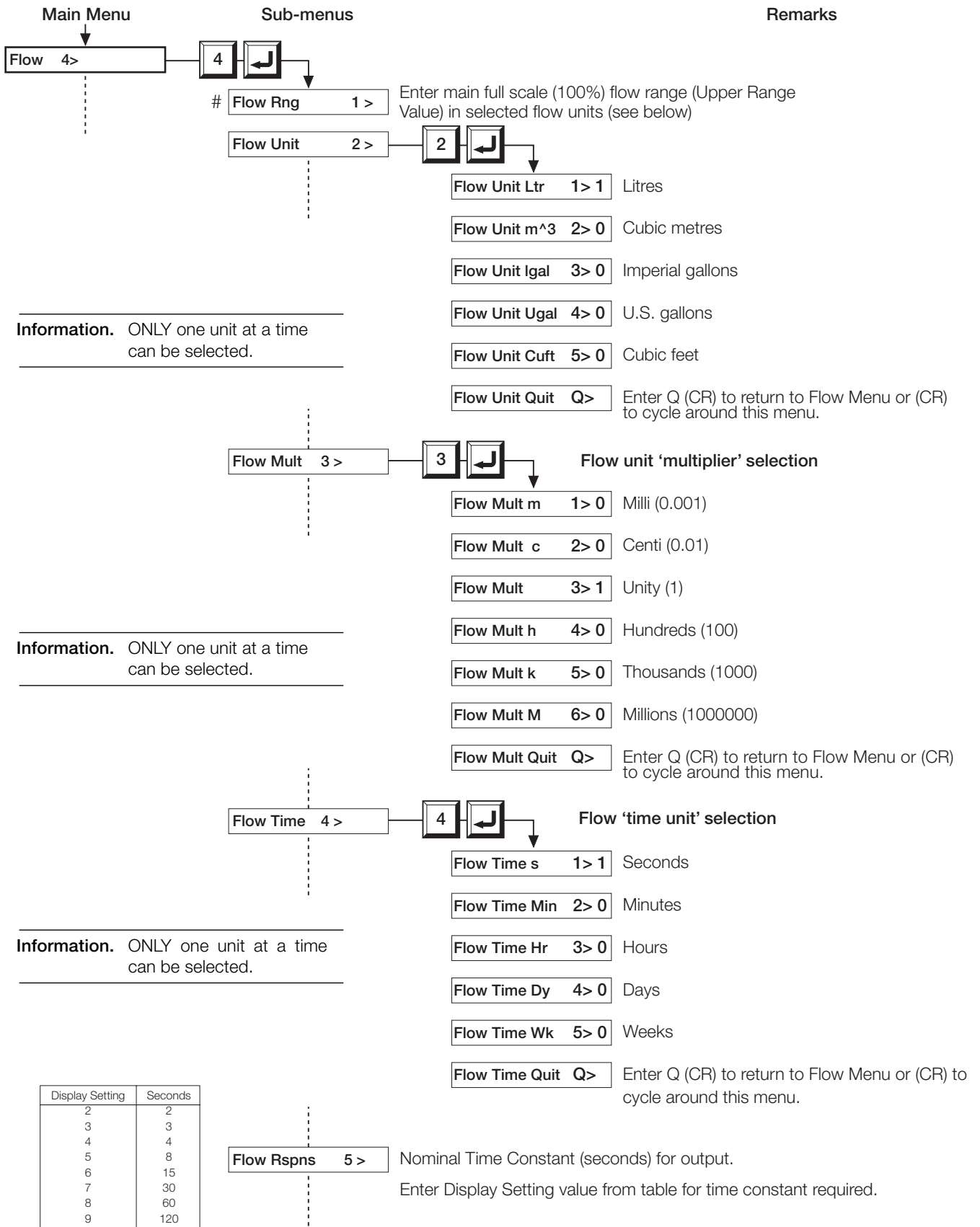

Information. ONLY one unit at a time can be selected.

Information. ONLY one unit at a time can be selected.

Information. ONLY one unit at a time can be selected.

...APPENDIX B

...B1.2 Description of Parameters

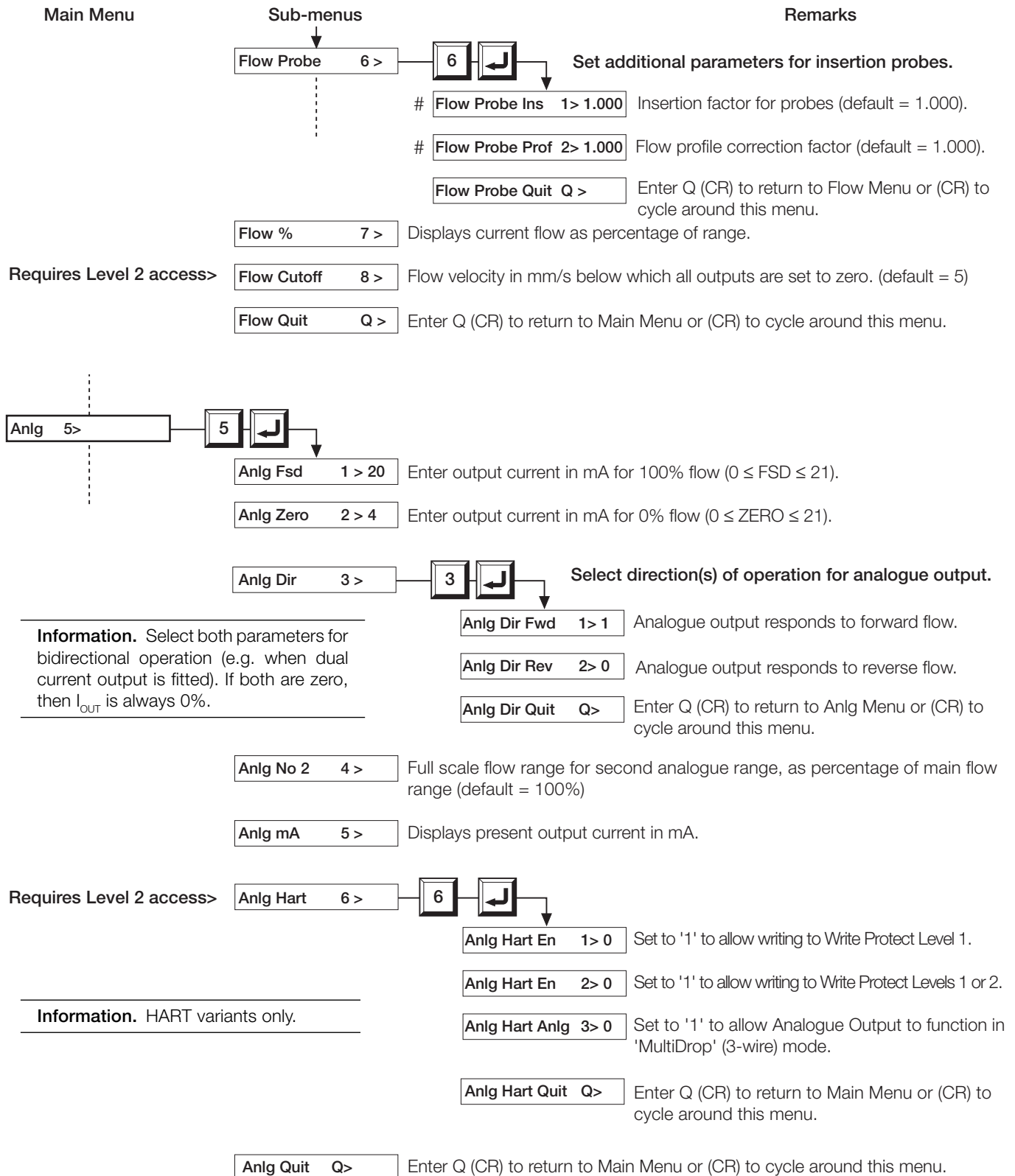

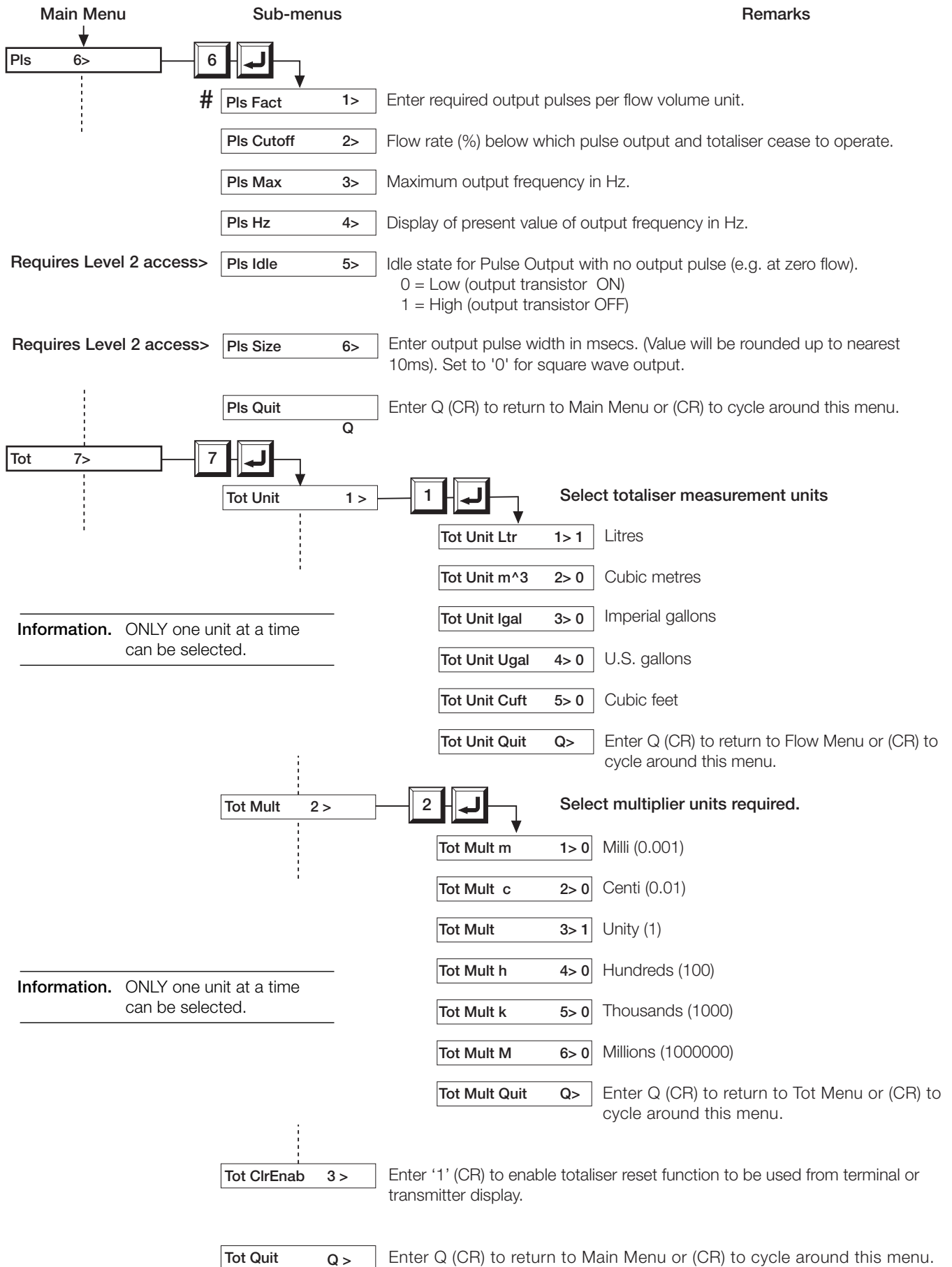

...APPENDIX B

...B1.2 Description of Parameters

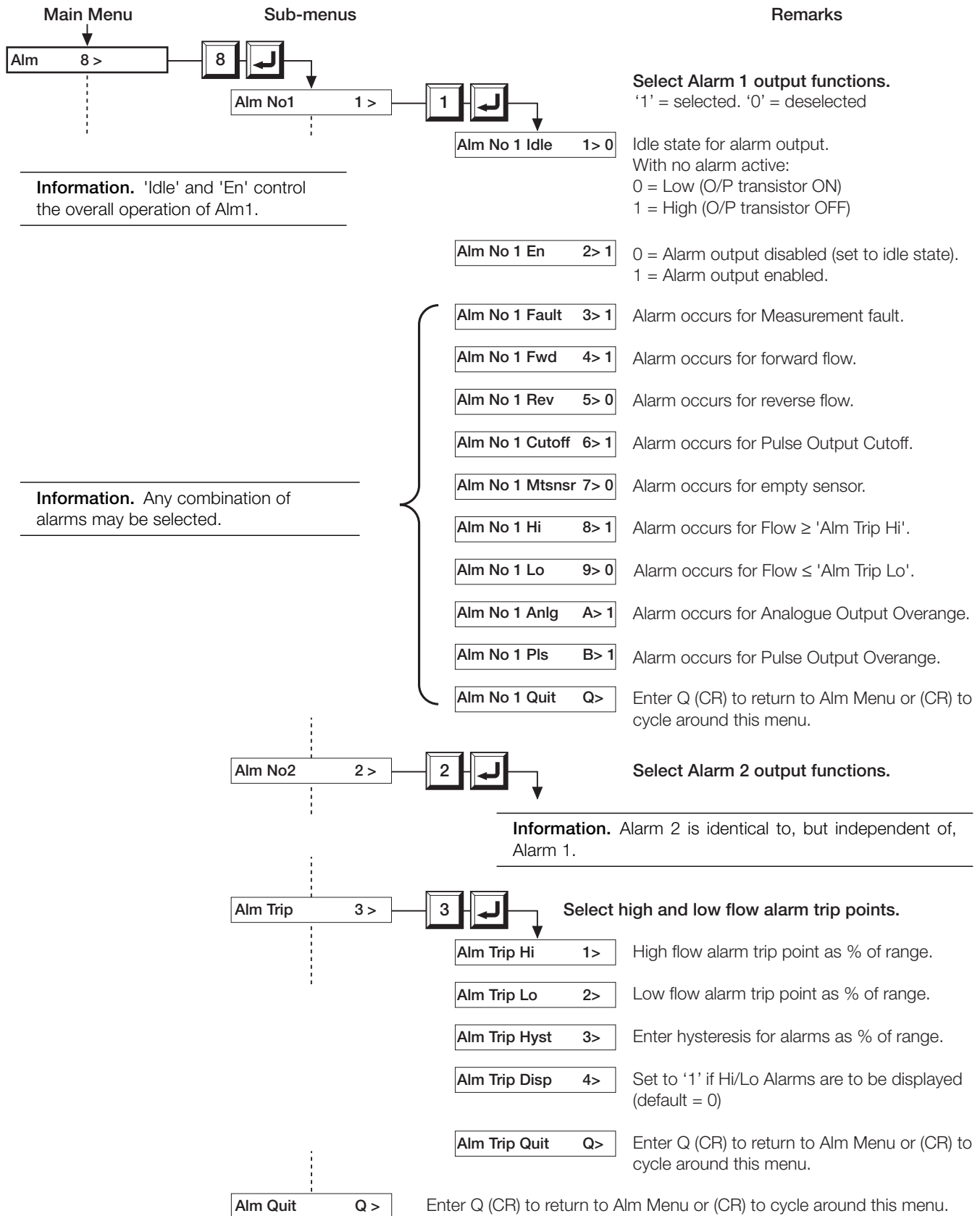

Information. 'Idle' and 'En' control the overall operation of Alm1.

Information. Any combination of alarms may be selected.

Main Menu	Sub-menus	Remarks
Input 9 >	9	Set up function of external logic input (EXT I/P+, EXT I/P- terminals on transmitter cable termination BLK2).
	Input Anlg 1 > 0	Active level on contact input selects Analogue Range 2
	Input Clr 2 > 1	Active level on contact input will reset totaliser.
	Input Hld 3 > 0	Active level on contact input will hold flowmeter output value.
	Input Zero 4 > 0	Active level on contact input will set flowrate output to zero.
	Input Idle 5 > 0	Enter inactive state of input contact ('1' for Hi normal: '0' for Lo normal).
	Input Quit Q >	Enter Q (CR) to return to Main Menu or (CR) to cycle around this menu.

Information. Only one function may be selected.

Requires Level 2 access>

Information. The following parameters require 'Level 2' access. Enter password in 'Login En' parameter above ('31' from Main Menu).

Mtsnsr A >	A	Set up empty pipe detection.
	Mtsnsr Trip 1 >	Set empty pipe detector trip threshold.
	Mtsnsr mv 2 >	Actual measured value related to fluid conductivity.
	Mtsnsr Quit Q	Enter Q (CR) to return to Main Menu or (CR) to cycle around this menu.

Snsr B >	B	Sensor calibration details etc.
	Snsr No 1 >	Descriptor (up to 13 characters).
	Snsr Tag 2 >	Tag and date (exactly 13 characters). Format: TTTTTTTDDMY (Required for HART™ units only) Where T = Tag (exactly 8 characters/spaces) DD = 01 to 31 (day of month – 2 digits) M = 1 to 9, O, N or D (month – 1 character) YY = 00 to 99 (year – 2 digits)
	Snsr Size 3 >	Sensor calibrated bore, in millimetres.
	Snsr Vel 4 >	Displays the current velocity in the sensor.
	Snsr Fact 5 >	5
	# Snsr Fact 1 >	} Sensor calibration data - should agree with sensor data label
	Snsr Fact 2 >	
	Snsr Fact 3 >	
	Snsr Fact 4 >	
	Snsr Quit Q	
	Snsr Quit Q	Enter Q (CR) to return to Main Menu or (CR) to cycle around this menu.

...APPENDIX B

...B1.2 Description of Parameters

Main Menu	Sub-menus	Remarks
Test C >	C J	System Test: Exercises all outputs (as programmed) from manually entered flowrate.
	Test Mode 1 >	If set to '1', transmitter is in 'Test Mode'
	# Test Flow 2 >	Displays current flowrate: if in 'Test Mode', then any value may be entered manually
	Test % 3 >	Flowrate as a percentage.
	Test Hz 4 >	Output Frequency.
	Test mA 5 >	Output Current.
	Test Vel 6 >	Flow velocity in sensor (for the flowrate above).
	Test Alm 7 >	Shows currently active alarms, *sequentially ('Clr' indicates no alarms active).
	Test Txv 8 >	Live flow velocity (uncorrected for sensor calibration).
	Test Quit Q	Enter Q (CR) to return to Main Menu or (CR) to cycle around this menu.

} Calculated from 'Test Flow 2' above

Information. 'Test Mode' self-cancels after 30 minutes, if no further entries are made.

* If the sensor is empty or disconnected, the alarms 'MtSnsr' and Coil will be displayed as appropriate.

The maximum which can be entered must not exceed 21000. The value entered may be displayed with a small error in the decimal digits e.g. 1.900 may be displayed as 1.899. This is a display characteristic and the value 1.900 will be used by the MagMaster.

END OF PARAMETERS

APPENDIX C MAGMASTER SYSTEM DIAGRAM

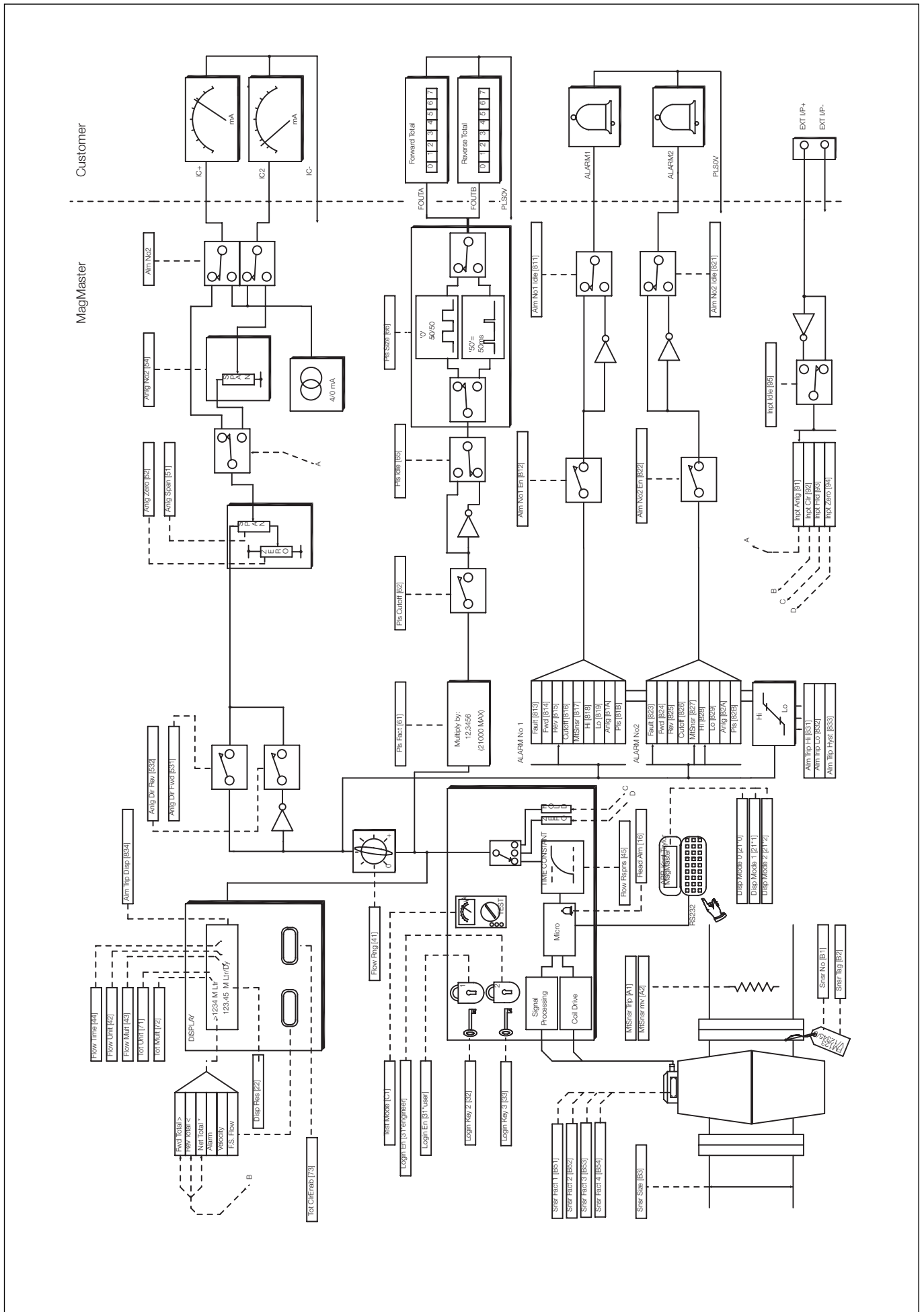

PRODUCTS & CUSTOMER SUPPORT

Products

Automation Systems

- *for the following industries:*
 - Chemical & Pharmaceutical
 - Food & Beverage
 - Manufacturing
 - Metals and Minerals
 - Oil, Gas & Petrochemical
 - Pulp and Paper

Drives and Motors

- *AC and DC Drives, AC and DC Machines, AC Motors to 1kV*
- *Drive Systems*
- *Force Measurement*
- *Servo Drives*

Controllers & Recorders

- *Single and Multi-loop Controllers*
- *Circular Chart and Strip Chart Recorders*
- *Paperless Recorders*
- *Process Indicators*

Flexible Automation

- *Industrial Robots and Robot Systems*

Flow Measurement

- *Electromagnetic Flowmeters*
- *Mass Flowmeters*
- *Turbine Flowmeters*
- *Flow Elements*

Marine Systems & Turbochargers

- *Electrical Systems*
- *Marine Equipment*
- *Offshore Retrofit and Refurbishment*

Process Analytics

- *Process Gas Analysis*
- *Systems Integration*

Transmitters

- *Pressure*
- *Temperature*
- *Level*
- *Interface Modules*

Valves, Actuators and Positioners

- *Control Valves*
- *Actuators*
- *Positioners*

Water, Gas & Industrial Analytics Instrumentation

- *pH, Conductivity, and Dissolved Oxygen Transmitters and Sensors*
- *Ammonia, Nitrate, Phosphate, Silica, Sodium, Chloride, Fluoride, Dissolved Oxygen and Hydrazine Analyzers.*
- *Zirconia Oxygen Analyzers, Katharometers, Hydrogen Purity And Purge-gas Monitors, Thermal Conductivity.*

Customer Support

We provide a comprehensive after sales service via a Worldwide Service Organization. Contact one of the following offices for details on your nearest Service and Repair Centre.

United Kingdom

ABB Limited
Tel: +44 (0)1453 826661
Fax: +44 (0)1453 829671

United States of America

ABB Inc.
Tel: +1 215 674 6000
Fax: +1 215 674 7183

Client Warranty

Prior to installation, the equipment referred to in this manual must be stored in a clean, dry environment, in accordance with the Company's published specification.

Periodic checks must be made on the equipment's condition. In the event of a failure under warranty, the following documentation must be provided as substantiation:

1. A listing evidencing process operation and alarm logs at time of failure.
2. Copies of all storage, installation, operating and maintenance records relating to the alleged faulty unit.

ABB has Sales & Customer Support
expertise in over 100 countries worldwide

www.abb.com

The Company's policy is one of continuous product
improvement and the right is reserved to modify the
information contained herein without notice.

Printed in UK (11.04)

© ABB 2004



ABB Limited
Oldends Lane, Stonehouse
Gloucestershire
GL10 3TA
UK
Tel: +44 (0)1453 826661
Fax: +44 (0)1453 829671

ABB Inc.
125 E. County Line Road
Warminster
PA 18974
USA
Tel: +1 215 674 6000
Fax: +1 215 674 7183